

# **SWIMMING POOL DEHUMIDIFIER**

## **Installation & Operation Manual**

# CONTENT

1. Preface	1
2. Safety Precautions	2
2.1 Marks	2
2.2 Icons	2
2.3 Warnings	2
2.4 Attention	3
3. Specifications	4
3.1 Parameters	4
3.2 Performance Curve	5
3.3 Dimensions	6
3.4 Working Principle	6
3.5 Product Features	7
3.6 Hygrostat Control	7
4. Installation	8
4.1 Installation Precautions	8
4.2 Positioning	8
4.3 Minimum Installation Distances	8
4.4 Drainage	9
5. Usage	10
5.1 Instruction for Operation Panel	10
5.2 Operation Instruction	11
5.3 Remote Control Switch User Guide	12
6. Maintenance	13
6.1 Maintenance	13
6.2 Troubleshootings	14
7. Appendix	15
7.1 PCB I/O Port	15

# 1. Preface

---

Thank you for choosing Swimming Pool Dehumidifier for controlling the climate in your pool area. This product strictly complies with design and production standards to provide perfect performance, high reliability and good adaptability for you.

Read the entire manual before the initial start-up of the unit. It is important to know the correct operating procedures for the unit and all safety precautions to prevent the possibility of property damage and/or personal injury. Do not modify or intervene on the unit by yourself only as this could create dangerous situations and the manufacturer will not be responsible for any damage caused.

This instruction must be kept carefully and must always accompany the appliance. If it is lost or damaged, please contact the local technical service center.

## 1.1 Fail to comply with these recommendations will invalidate the warranty.



- This unit must be installed by an authorized installer.
- All repair or maintenance interventions must be performed by the technical service department or by professionally qualified personnel.
- All repair or maintenance interventions must be performed in the specified period and times.
- Use the spare parts ONLY provided by the manufacturer.

1.2 In case of system leakage, disconnect the power to the unit and call the technical service department or other professionally qualified personnel as soon as possible, and do not intervene personally on the appliance.

If the unit is not used for a long time, you should disconnect the power to the unit.

## 1.3 Packing List (Fig.1)

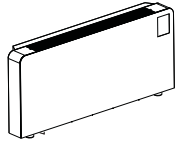
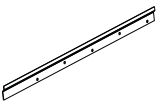

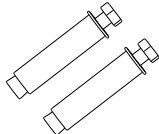
Fig.1

Main unit	Wall suspension bar	Manual	Expansion bolts
			



## 2. Installation Precautions

---



### 2.1 Marks



Mark	Meaning
 WARNING	A wrong operation may lead to death or heavy injury on people.
 ATTENTION	A wrong operation may lead to harm to people or loss of property.



### 2.2 Icons

Icon	Meaning
	Prohibition. What is prohibited will be nearby this icon.
	Compulsory implement. The listed actions need to be taken.
	Attention(include warnings) Please pay attention to what is indicated.

### 2.3 Warnings

INSTALLATION	 PROFESSIONAL INSTALLER IS REQUIRED	Entrust a specialized personnel for installation. Wrong installation may cause leakage, personnel electric shock or fires.
	 EARTHING IS REQUIRED	Confirm whether whether the unit is with correct earthing. Wrong connection may cause personnel shock.



OPERATION	 PROHIBITION	Do not put fingers or others into the fan or evaporator of the unit, otherwise harm may be occurred.
	 SHUT OFF THE POWER	When there is something wrong or strange smell from the unit, please cut off the power to the unit immediately.



MOVE AND REPAIR	 ENTRUST	When the unit needs to be moved or installed again, please entrust dealer or qualified person to carry it out. Improper installation may lead to water leakage, electrical shock, injury or fire.
	 PROHIBIT	It is prohibited to repair the unit by the user himself, otherwise electrical shock or fire may occur.
	 ENTRUST	When the unit needs to be repaired, please entrust dealer or qualified person to carry it out. Improper movement or repair on the unit may lead to water leakage, electrical shock, injury or fire.

## 2. Installation Precautions

---

### 2.4 Attention

INSTALLATION	Meaning
 Fix the unit	Make sure that the basement of the unit is strong enough to avoid any decline or fall down.
 Need circuit breaker	Make sure that there is circuit breaker for the unit. Lack of circuit breaker can lead to electrical shock or fire.

OPERATION	Meaning
 Check the installation basement	Please check the installation basement regularly to avoid any decline or damage which may hurt people or damage the unit.
 Disconnect the power	Please disconnect the power to the unit for clean or maintenance.
 Prohibit	Please use the suitable fuse. If copper or iron is used to replace the fuse, it will cause failure, even fire.



### Warning:

Remember that some fundamental safety rules should be followed when using this product:

1. This appliance is not intended for use by persons (including children) with reduced physical, sensory or mental capabilities, or lack of experience and knowledge, unless they have been given supervision or instruction concerning use of the appliance by a person responsible for their safety. Children should be supervised to ensure that they do not play with the appliance.
2. It is forbidden to touch the appliance with wet hands or body when barefoot.
3. It is forbidden to carry out any cleaning before having disconnected the appliances from the electricity mains supply by turning the system master switch to OFF.
4. It is forbidden to modify the safety or adjustment devices or adjust without authorization and indication of the manufacturer.
5. It is forbidden to pull, cut or knot the electrical cables coming out of the appliance, even if it is disconnected from the mains supply.
6. If the supply cord is damaged, it must be replaced by the manufacturer, its service agent or similarly qualified persons in order to avoid a hazard.
7. It is forbidden to poke objects or anything else through the inlet or outlet grills.
8. It is forbidden to dispose of or leave in the reach of children the packaging materials which could become a source of danger.
9. It is forbidden to climb onto the appliance or rest any object on it.
10. It is forbidden to touch the unit with hands directly as the external parts of the appliance can reach temperatures of more than 70°C.
11. The appliance shall be installed in accordance with national wiring regulations.

### 3. Specifications

---

#### 3.1 Parameters

● Swimming Pool Dehumidifier

Model	Unit	590ST022	590ST030	590ST043
Rated Capacity	L/h	2.2	3.0	4.3
Dehumidification capacity per day	L	53	72	103
Max pool area	m <sup>2</sup>	42	60	83
Noise Level	dB(A)	44	46	48
Rated Voltage/Freq	/	220-240V ~/50Hz		
Rated Power Input	kW	0.93	1.13	1.97
Rated Running Current	A	4.1	5.0	8.7
Max.Power Input	kW	1.02	1.32	2.28
Max.Running Current	A	4.3	5.85	10
Relative Humidity	%RH	40 ~ 90	40 ~ 90	40 ~ 90
Temperature	℃	10 ~ 36		
Dimensions(L/W/H)	mm	See 3.3		
Net Weight	kg	See nameplate/ package label		
Refrigerant	/	R410A		
Condensation Pipe Diameter	mm	16	16	16

Test condition: Ambient temperature: 30℃, Relative humidity: 80%.

Operating limits: temperature 10℃~36℃  
relative humidity 40%~90%

### 3. Specifications

---

#### 3.2 Performance Curve

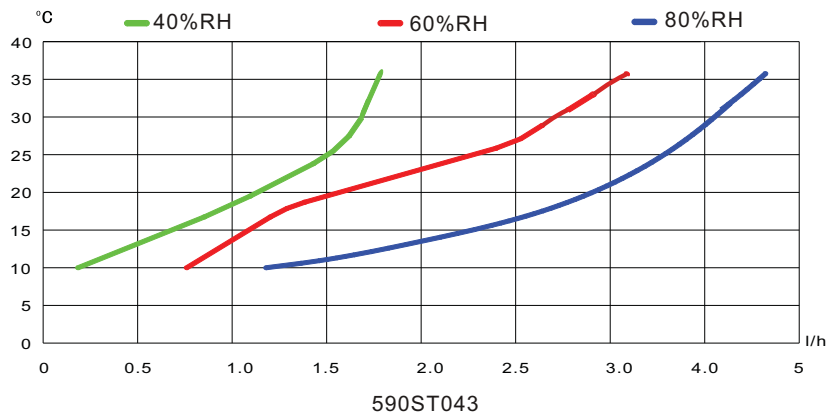
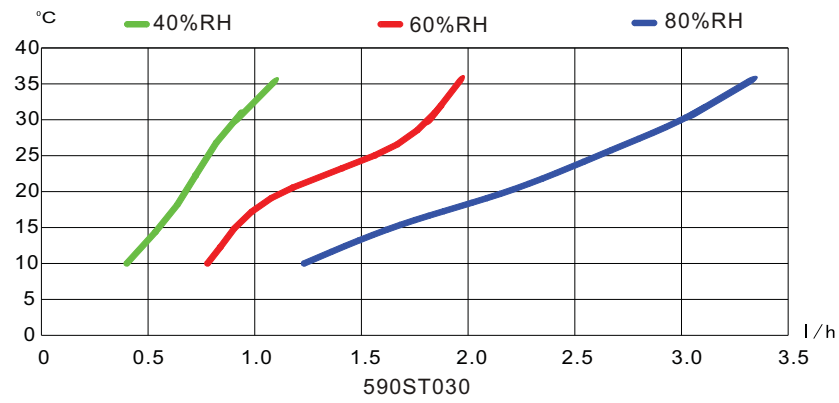
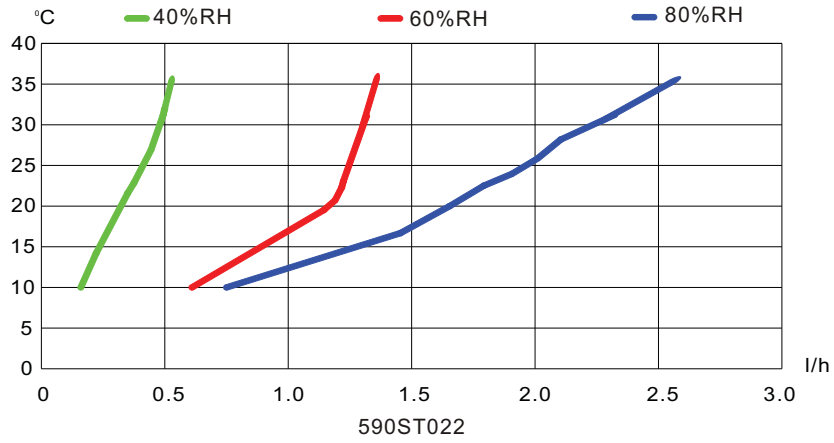

### 3. Specifications

#### 3.3 Dimensions

##### 3.3.1 Applicable product model: 590ST-022/030/043

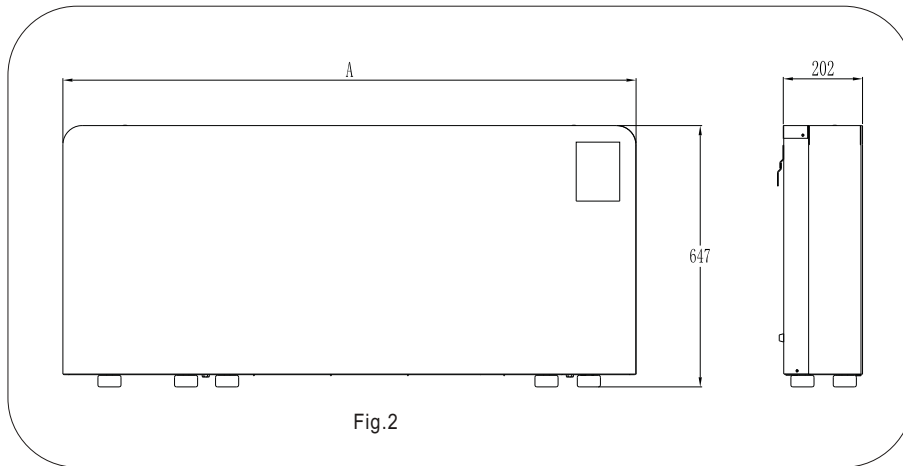

Model	590ST022	590ST030	590ST043
Length: A	1295	1495	1495

#### 3.4 Working Principle:

The unit works by drawing moist air over a refrigerated coil with a small fan. The cold coil of the refrigeration device condenses the water, which is removed, then the air is reheated by the hot coil. This process works most effectively with higher ambient temperatures with a high dew point temperature(Fig.3).

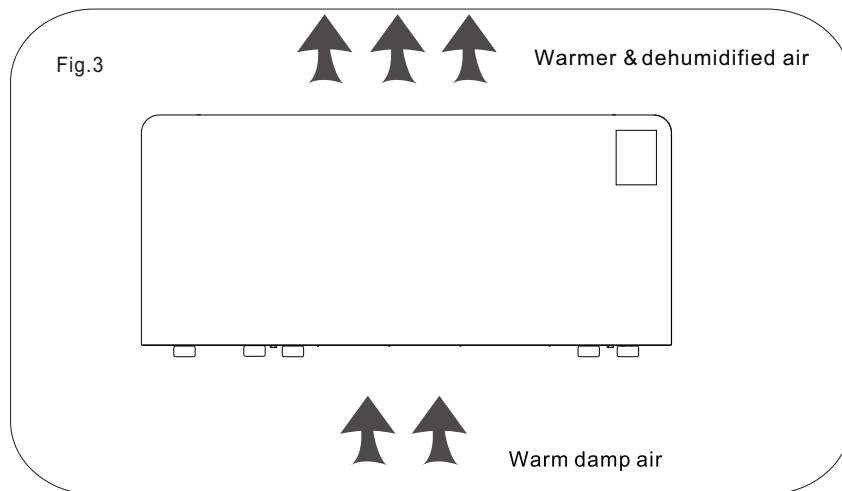



### 3. Specifications

---

#### 3.5 Product Features

##### 3.5.1 Ultra-low noise

With the advanced air ducting technology and the super quiet cross-flow fan, the unit can operate with ultra-low noise.

##### 3.5.2 Ultra-thin casing

With the ultra-thin casing of 200mm, which is the result of compact design, the unit can save more space for you when it is compared with the common dehumidifiers with the thickness of 400mm.

##### 3.5.3 Fashionable appearance

With noble & fashion arc frame and elegant & graceful snow white color, the unit will be perfectly combined with your pool house.

##### 3.5.4 Newly design controller.

With simple operating display, the newly developed controller makes the unit operation easier and more user-friendly.

#### 3.6 Hygrostat Control

3.6.1 The dehumidifier is controlled by a built-in hygrostat set on one side of the unit and the target RH value can be set ranges from 30% to 90%.

3.6.2 The unit will not start to dehumidify until the actual RH is beyond the setting value.

3.6.3 We recommend that an external hygrostat should be installed to ensure a constant measure of the humidity in the pool area.

3.6.4 The location of hygrostat is as the following (Fig.4):

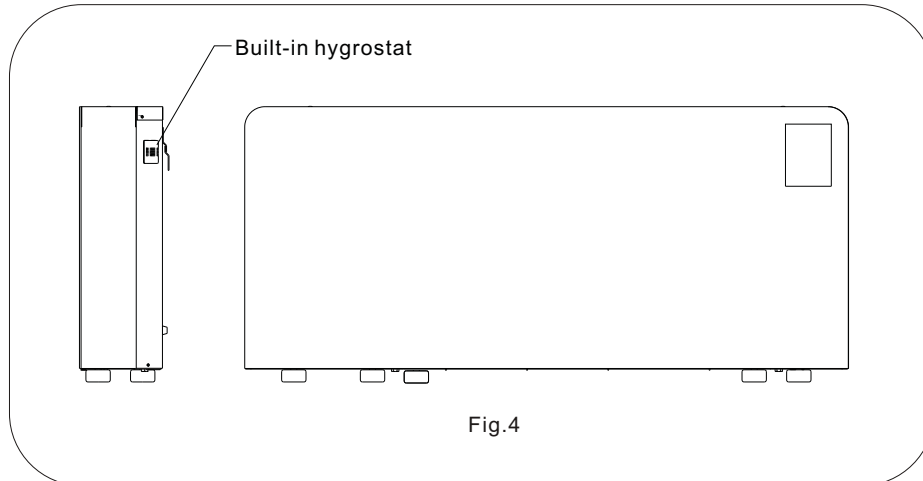

Fig.4

## 4. Installation

---

### 4.1 Installation Precautions

4.1.1 To ensure that the installation is performed correctly and that the appliance will perform perfectly, please carefully follow the instructions indicated in this manual. Fail to respect the rules indicated not only can cause malfunctions of the appliance but also invalidate the warranty, hence our company shall not respond for any damage to persons, animals or property.

4.1.2 It is important that the electrical installation is made according to the laws in force, respects the data indicated in the technical sheet and the unit is correctly earthed.

4.1.3 The appliance must be installed in a position that allows the routine maintenance, such as filter cleaning.

### 4.2 Positioning

4.2.1 Avoid installing the unit in proximity to:

- positions subject to exposure to direct sunlight;
- sources of heat;
- in places with oil fumes
- places subject to high frequencies.

4.2.2 Make sure that:

- the wall on which the unit is to be installed is strong enough to support the weight;
- the part of the installation wall does not have pipes or electric wires passing through;
- the installation wall is perfectly flat;
- there is an area free of obstacles which could interfere with the inlet and outlet air flow;
- it is preferably that there is an outside perimeter-wall to allow the discharge of condensation outside;

### 4.3 Minimum Installation Distances

4.3.1 Removing the four rubber feet of the unit are suggested if hanging it on the wall.

4.3.2 Fig. 5 indicates the minimum mounting distances between the wall-mounted swimming pool dehumidifier and furniture in the room.

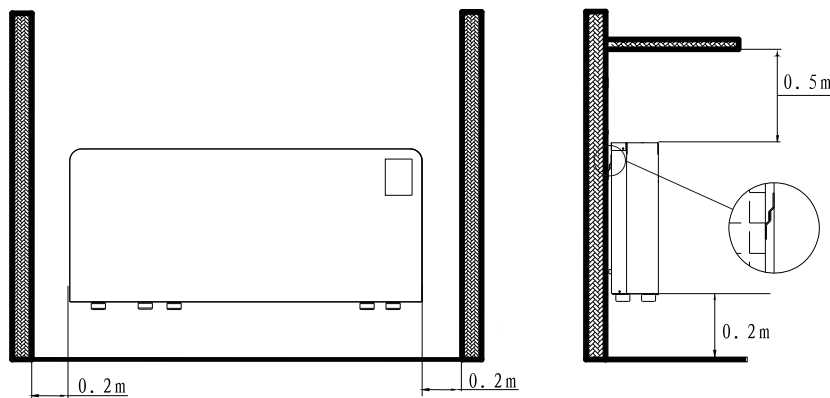
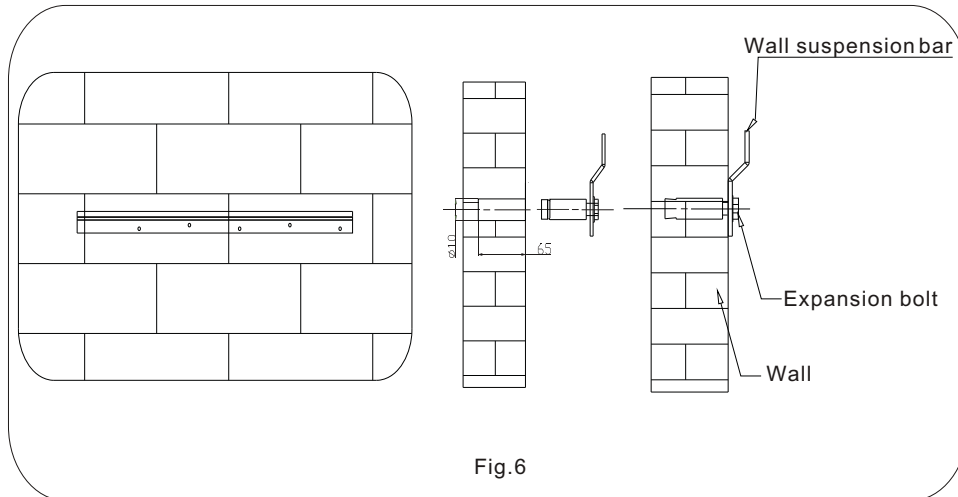

Fig.5

## 4. Installation

### 4.3.3 Wall mounted installation

Insert 5 expansion bolts into holes which are bored by  $\phi 10$  drill and fix the wall suspension bar horizontally(Fig.6).



### 4.4 Drainage

Select a suitable size hose to connect to the built-in hose if it is needed(Fig.7).

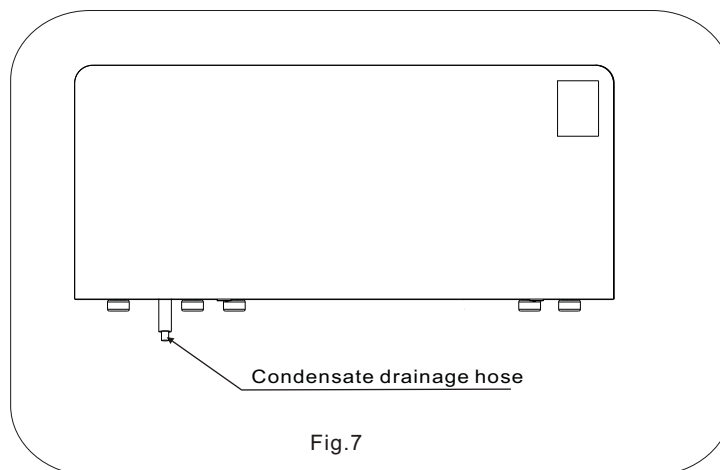

 Attention:

- If the condensation water discharges directly into a container, the condensate outlet should be above the container to avoid immersing in the container.

## 5. Usage

---

### 5. 1 Operation Tablet Functions

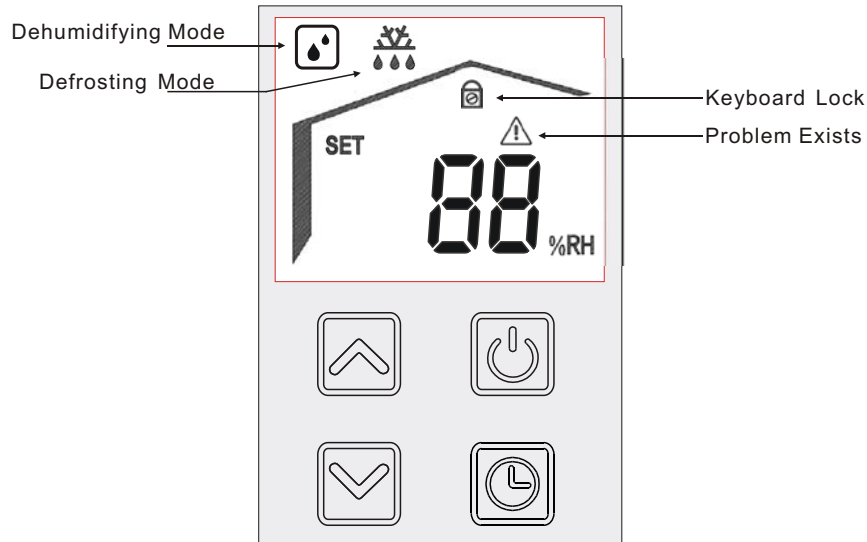





#### Notice:

As the humidity sensor of the units needs 15s for heat reflection, when the units start up, users should wait 15s till the units show exact ambient relative humidity.

During the 15s, users cannot do any operation. The screen shows 8. 8. At the first 5s, and shows program version number such as 1. 0 at the later 10s.

Keys will light off after 90s no operation. After that, when you first touch the keys, the keys will light up. Now you can do other operation to the units.

#### 5. 1. 1 Buttons

-  ON/OFF  
Press this button to start up/shut down the units. Press this button for 5s to lock/unlock the keyboard.
-  UP  
Press this button to check relative humidity target value;  
Press this button again to increase relative humidity target value.
-  DOWN  
Press this button to check relative humidity target value;  
Press this button again to decrease relative humidity target value.
-  TIMER  
When the unit is off, you can set startup time by pressing this button;  
When the unit is on, you can set shutdown time by pressing this button;

## 5. Usage

### 5.2 Operation Tablet User Guide

#### 5.2.1 Power on/off

You can turn on/off the units by pressing the power button .

When the units are turned on, the tablet displays current ambient relative humidity. The mode icon and power button light up.

When the units are turned off, the tablet will not display current ambient relative humidity. The mode icon and power button will not light up.

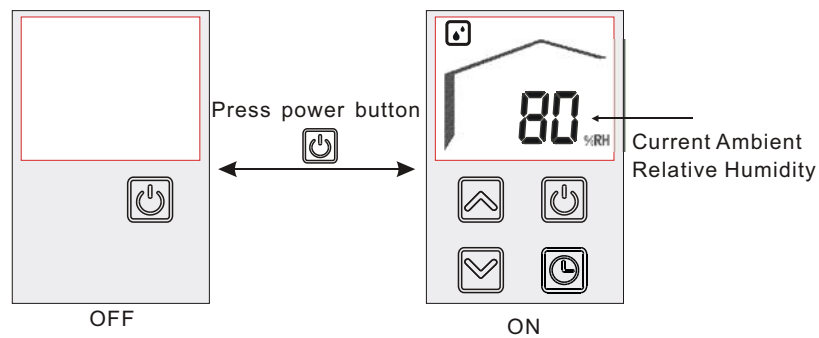

#### 5.2.2 Set Relative Humidity

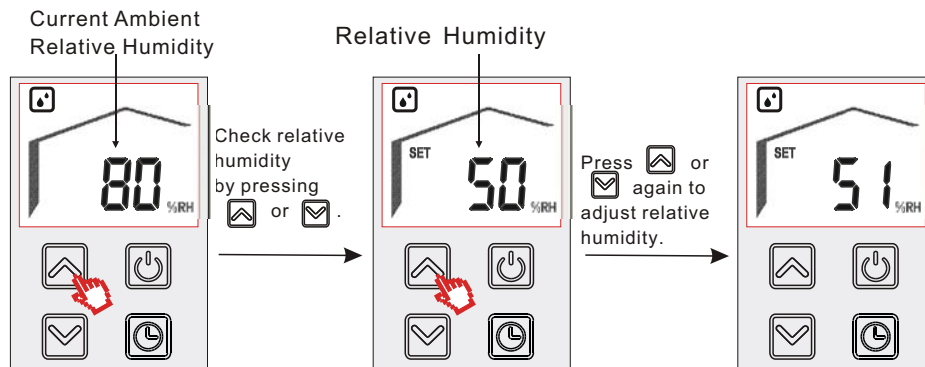

Notice:

1. After adjusting the relative humidity, if the users have no operation in 5s, the screen will turn to homepage and save users setting automatically.
2. If turn on the units again, the system will work according to the last adjustment.

## 5. Usage

---

### 5.2.3 Dehumidifying mode

When the unit is in dehumidifying mode, the LED for icon "💧" lights up, and:

1. If  $A(\text{actual relative humidity of room air}) \geq \text{TRH}(\text{target relative humidity}) + 5\%RH$ , and this condition has lasted for 30s, the unit will start to dehumidify.
2. If  $A(\text{actual relative humidity of room air}) \leq \text{TRH}(\text{target relative humidity}) - 5\%RH$ , and this condition has lasted for 3mins, the unit will halt the dehumidifying..

### 5.2.4 Defrosting mode

When the ambient temperature is low, for example,  $11^{\circ}\text{C}$ , and after the unit has worked for a period of time, possibly, the evaporator will start to ice up. So the unit will switch to defrosting mode automatically. During defrosting, the LED for icon "❄️" lights up. When defrosting is over, the unit will return to the dehumidifying mode, and operate according to the condition mentioned above.

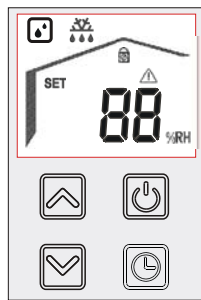

### 5.2.5 Problem Display

When there is a problem with the units, the control tablet will display a relative problem code. Get more information about the specific problem code meaning, please check the problem code list at page 15 for reference.

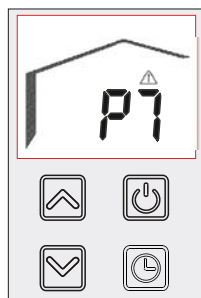

## 6. Maintenance

### 6.1 Maintenance

- To guarantee the unit reliable and security operation for along time, it is suggested to maintain and clean up the unit every six months.
- Please take the following steps to clean up the strainer regularly:
  - 1) Press the two red buttons and drag it down slowly ( Fig.8 ) ;
  - 2) Separate the return air filter screen from the units as the image shown below ( Fig.9 ) ;
  - 3) Take away the return air filter screen and flush it with water ( Fig.10 ) .

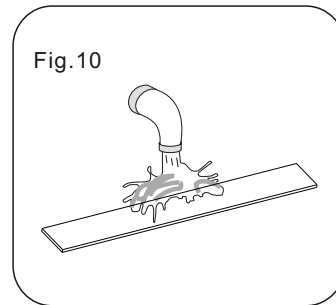
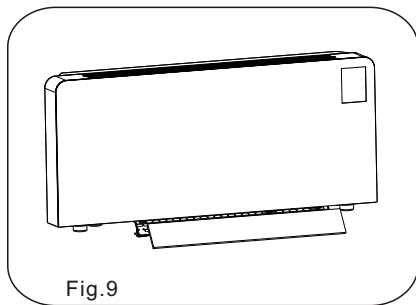
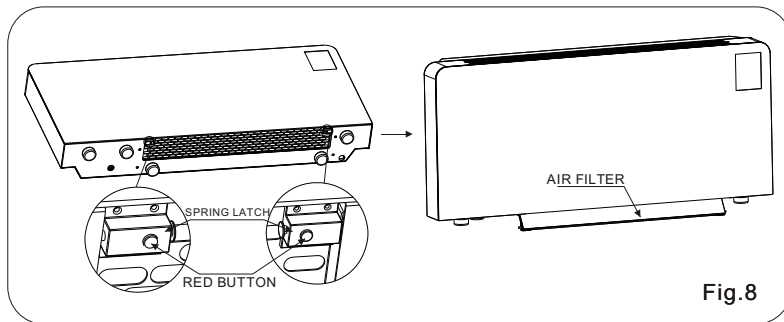

- 4) Set the filter net and the air return grille to the original place and press the limiting pin. (Fig.11).
- 5) Clean up the unit outer with soft and damp rag (Fig.12) . To protect the paint-coat of the unit, please don't use rough sponge or corrosive detergent to do these.

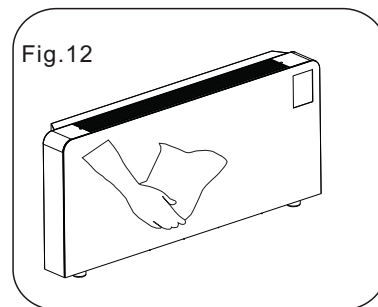
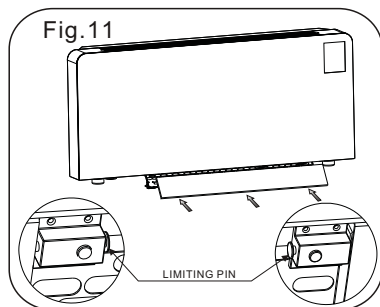

Warning: Cut off power supply before cleaning or maintaining the unit.

## 6. Maintenance

---

### 6.2 Trouble shooting

Press the key of "UP" or "Down" to check that if there are more failure codes.  
You can find solutions to the problems according to the codes.

Malfunction	Code	Reason	Solution
High pressure protection has appeared 3 times in 30mins or Low pressure protection has appeared 3 times in 30mins	P1	High pressure protection or Low pressure protection is too frequently.	Check the below solutions to failure P1/P2/P3
High pressure protection or Low pressure protection	P2	Discharge pressure is too high or Compressor suction pressure is too low	
Condenser outlet temp. overhigh	P3	Condenser coil temp. is too high	
Evaporator outlet temp. sensor failure	P5	This temp. sensor is broken or in open/short circuit	Check or replace this temp. sensor
Evaporator inlet temp. sensor failure	P6	This temp. sensor is broken or in open/short circuit	Check or replace this temp. sensor
Condenser outlet temp. sensor failure	P7	This temp. sensor is broken or in open/short circuit	Check or replace this temp. sensor
Humidity sensor failure	P8	Humidity sensor is broken or in open/short circuit	Check or replace this humidity sensor
Motor feedback signal failure	E0	The feedback wiring is in bad connection. Or fan motor is damaged.	1. Check the feedback wiring of fan motor. 2. Or replace the fan motor.

Solution to failure P1/P2/P3:

1. If P1/P2/P3 appears together with other failures, please solve the others first.
2. If there is no other failures of P3~E0, and P1 & P2 still exist, please disconnect the power to the unit and connect again after 1 hour.
3. If only P3 exists, please keep the fan running for 30min. If P3 still exist after the running, please disconnect the power to the unit and connect again after 1 hour.

Note: Please contact with Technical Service Assistance when failures can not be solved.



## 7. Appendix

### 7.1 PCB I/O Port

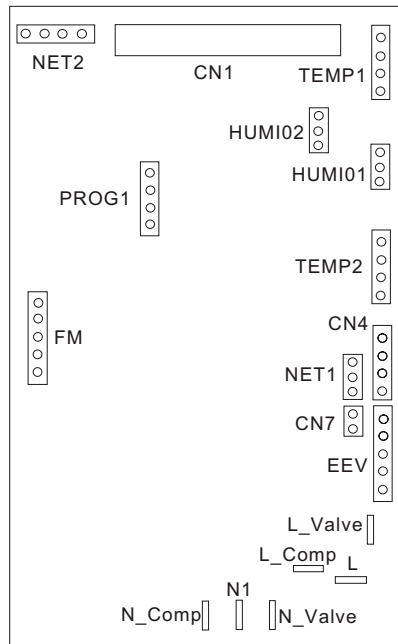

Explanation:

NO	Ports	Meaning
1	Cn1	To operation panel
2	CN4 NET1 NET2	Reserved
3	FM	To fan motor(DC)
4	TEMP1	To evaporator inlet/outlet temp. sensor
5	TEMP2	To condenser outlet temp. sensor
6	HUMI01	To the build-in RHS(Refer to 7.2)
7	HUMI02	To the external RHS (optional)
8	CN7	To high or Low pressure protection switch
9	EEV	To electronic expansion valve
10	PROG1	Program burning port
11	L	To the Live Wire of power supply
12	N1 N_Comp N_Valve	Neutral Wire
13	L_Comp	To the Live Wire of compressor





Code:20160109-0001