

# SCHWALLDUSCHE VODENE ATRAKCIJE

## VAGNER POOL

SWIMMING POOL TECHNOLOGY

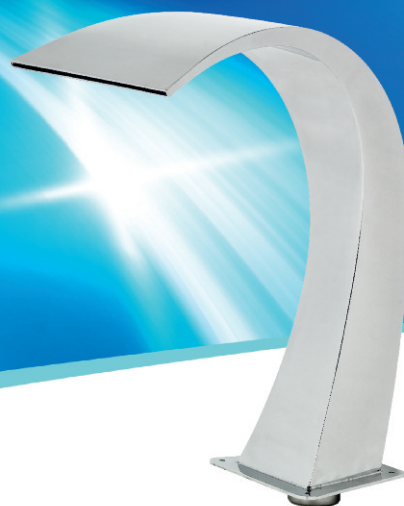

## Wasserattraktionen – Schwallduschen Vodene atrakcije – fontane

### Schwalldusche

Eine Schwalldusche ist nicht nur eine interessante Dekoration des Schwimmbeckens, sondern gewährleistet auch natürliche Sauerstoffversorgung des Wassers. Wasserfall, der durch fallendes Wasser aus einer Schwalldusche entsteht, kann man für sanfte Nacken- und Rückenmassage verwenden oder zur Schaffung einer Soundkulisse in entspannende Umgebung.

Schwallduschen werden in Edelstahl AISI 316 hergestellt und werden handpoliert, somit ist eine hohe Glanzqualität garantiert.

### Wasserattraktionen

- ▶ Hand poliert = hohe Glanzqualität
- ▶ Präzision und Ausführungsqualität
- ▶ Einfache Montage mit Hilfe vom Schnellanschluss
- ▶ Verbindung: Ø 75 mm

### Bazenska atrakcija

Bazenska atrakcija (vodopad), nije samo zanimljiv ukras bazena, već pruža i prirodnu oksigenaciju vode. Vodopad nastao padom vode iz atrakcije može biti korišten za nježnu masažu vrata i leđa ili za stvaranje zvučne kulise u okruženju za opuštanje.

Atrakcije su izrađene od nehrđajućeg čelika AISI 316 i ručno su polirane, sa svrhom visokokvalitetnog sjaja.

### Vodene atrakcije

- ▶ Ručno polirane = visoka kvaliteta sjaja
- ▶ Preciznost i kvalitetna izvedba
- ▶ Jednostavna montaža pomoću brzospojnog priključka
- ▶ Spoj: Ø 75 mm

**AISI 316**  
STAINLESS STEEL  
NEREZ





770015

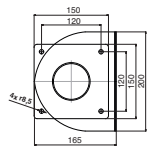
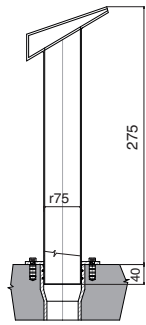

770016

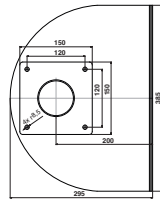
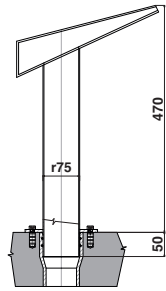

770014

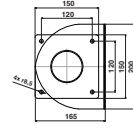
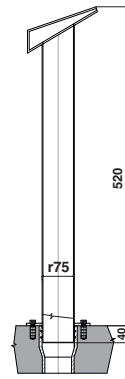

770004

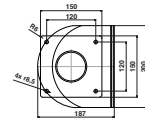
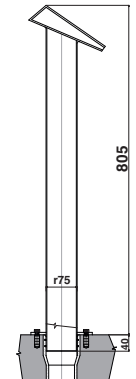

770012

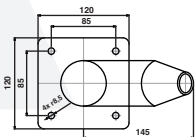
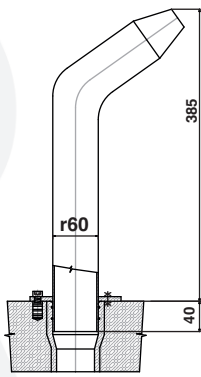

770013

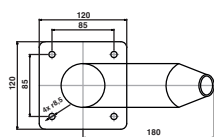
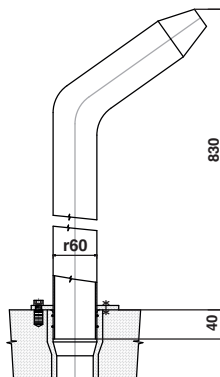

7709

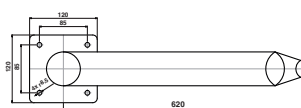
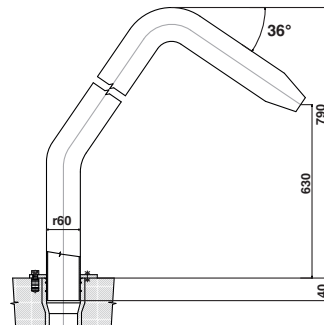

7712

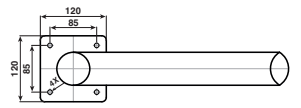
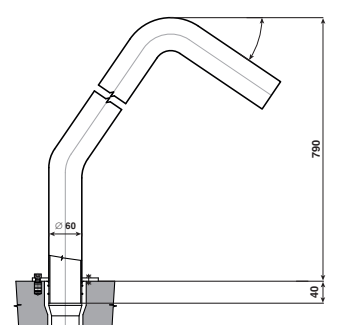



77055



77044



7711



7710

7705

7704

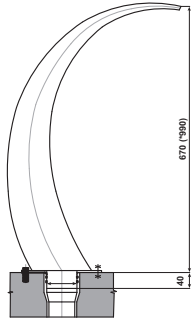

\* Abmessung für Maxi Kobra

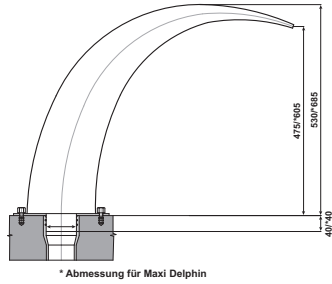

\* Abmessung für Maxi Delphin

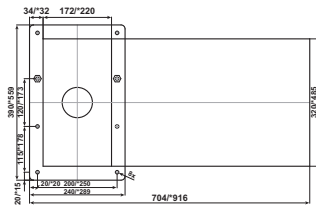
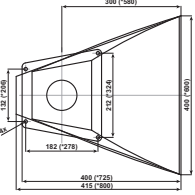
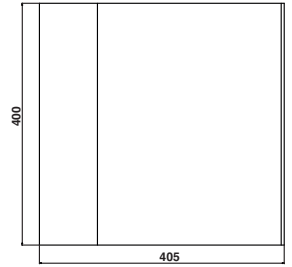
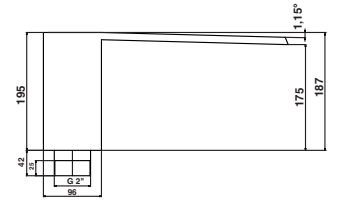
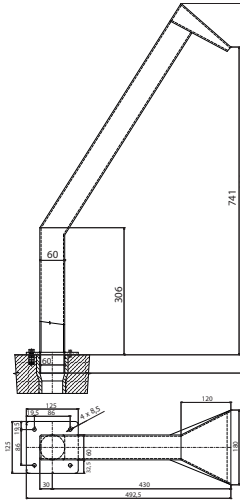

77081 - Glanzoberfläche



77066



7706



7700177

770017

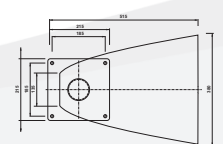
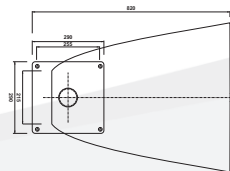
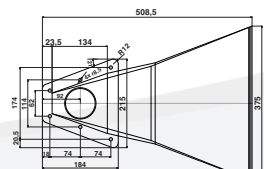
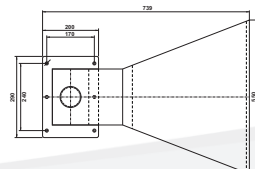
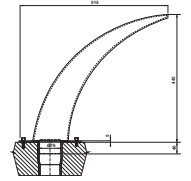
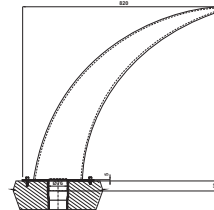
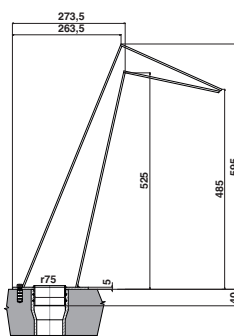
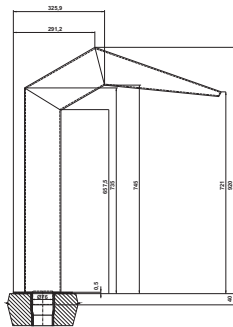
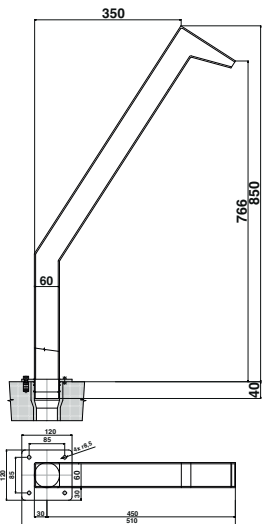

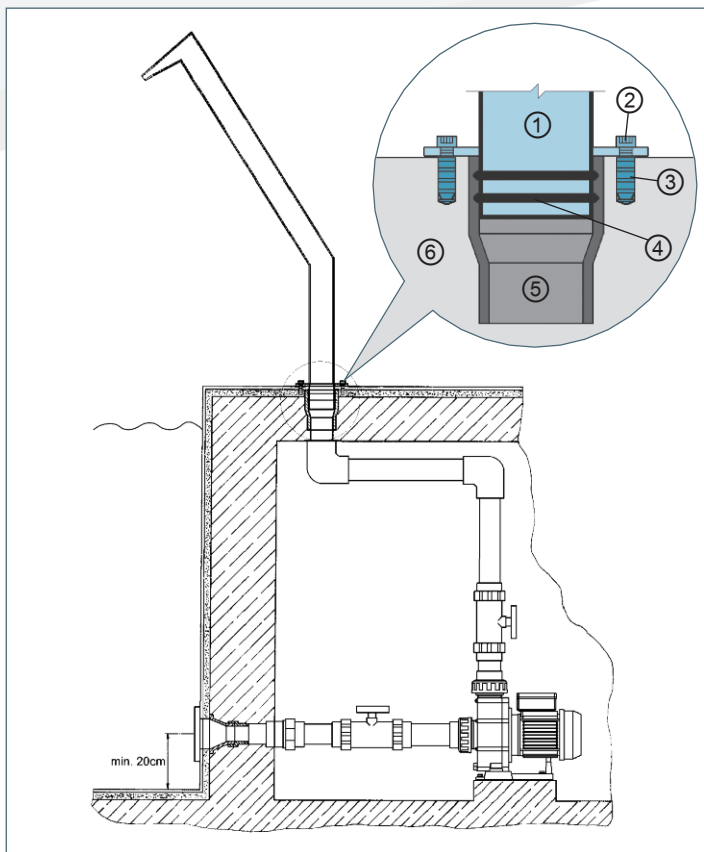

- ① Schwallduschenkörper – Edelstahl  
tijelo atrakcije – inox
- ② A Edelstahlschraube 8 x 100 mm  
vijak inox 8 x 100 mm  
B\*Edelstalschraube M8 x 30 mm  
vijak inox M8 x 30 mm
- ③ A Dübel 14 x 75 mm  
tipla 14 x 75 mm  
B\*Edelstahlverankerung 12 x 80 mm  
sidreni vijak inox 12 x 80 mm
- ④ Gummidichtung (O-Ring)  
gumena brtva (o-krug)
- ⑤ Schnellverbindung Ø 63 oder 75 mm  
brzospojni priključak Ø 63 ili 75 mm
- ⑥ Beton  
beton

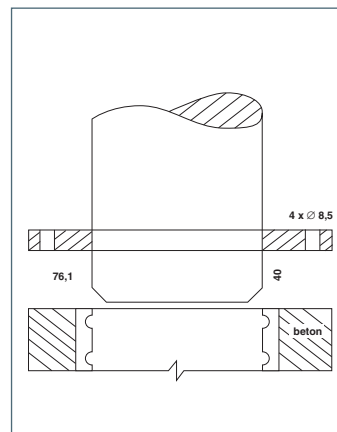

\*nur gegen Bestellung verfügbar  
\*samo kod narudžbe



Art. Nr. Šifra	Bezeichnung der Schwalldusche Naziv atrakcije	Wasserstrom Tok vode	Material Materijal	Oberfläche Površina	Verbindung Schwalldusche/ Rohrleitung Spoj atrakcije/cijevovoda	Druchfluss Protok
770004	Halbmond hoch visoki polumjesec	↓	Edelstahl AISI 316 inox AISI 316	Glanzoberfläche visoki sjaj	75 mm/63 mm	9-24 m³/h
770012	Pfeife niedrig niska pipa	↑	Edelstahl AISI 316 inox AISI 316	Glanzoberfläche visoki sjaj	63 mm/50 mm	6-9 m³/h
770013	Pfeife hoch visoka pipa	↑	Edelstahl AISI 316 inox AISI 316	Glanzoberfläche visoki sjaj	63 mm/50 mm	6-9 m³/h
770014	Halbmond hoch visoki polumjesec	↑	Edelstahl AISI 316 inox AISI 316	Glanzoberfläche visoki sjaj	75 mm/63 mm	6-16 m³/h
770015	Halbmond niedrig niski polumjesec	↑	Edelstahl AISI 316 inox AISI 316	Glanzoberfläche visoki sjaj	75 mm/63 mm	6-16 m³/h
770016	Halbmond breit široki polumjesec	↑	Edelstahl AISI 316 inox AISI 316	Glanzoberfläche visoki sjaj	75 mm/63 mm	9-24 m³/h
7704 77044	„Delphin“ / „Delfin“ „Maxi Delphin“ / „Maxi Delfin“	↓	Edelstahl AISI 316 inox AISI 316	Glanzoberfläche visoki sjaj	75 mm/63 mm	9-32 m³/h
7705 77055	„Kobra“ / „Cobra“ „Maxi Kobra“ / „Maxi Cobra“	↓	Edelstahl AISI 316 inox AISI 316	Glanzoberfläche visoki sjaj	75 mm/63 mm	9-32 m³/h
7706 77066	„Kubist“ / „Cubist“ „Maxi Kubist“ / „Maxi Cubista“	↓	Edelstahl AISI 316 inox AISI 316	atte Oberfläche mat sjaj	75 mm/63 mm	9-32 m³/h
77081	„Giraffe“ „Žirafa“	↓	Edelstahl AISI 316 inox AISI 316	Glanzoberfläche visoki sjaj	63 mm/50 mm	6-16 m³/h
7709	„Saxofon“ „Saxofon“	↓	Edelstahl AISI 316 inox AISI 316	Glanzoberfläche visoki sjaj	63 mm/50 mm	6-16 m³/h
7710	„Wandspeier“ „Ugradbena“	↓	Edelstahl AISI 316 inox AISI 316	Glanzoberfläche visoki sjaj	2" ext. Gewinde 2" ext. navoj	6-16 m³/h
7711	„Ente“ „Patka“	↓	Edelstahl AISI 316 inox AISI 316	Glanzoberfläche visoki sjaj	63 mm/50 mm	6-16 m³/h
7712	„Saxofon Dusche“ „Saxofon tuš“	↓	Edelstahl AISI 316 inox AISI 316	Glanzoberfläche visoki sjaj	63 mm/50 mm	6-16 m³/h
770017 7700177	„Welle“ / „Val“ „Maxi Welle“ / „Maxi Val“	↑	Edelstahl AISI 316 inox AISI 316	Glanzoberfläche visoki sjaj	75 mm/63 mm	9-32 m³/h