

# ASIN AQUA Eox Pro

2025

THE MOST ADVANCED TECHNOLOGY FOR CRYSTAL-CLEAR AND SAFE WATER IN YOUR POOL

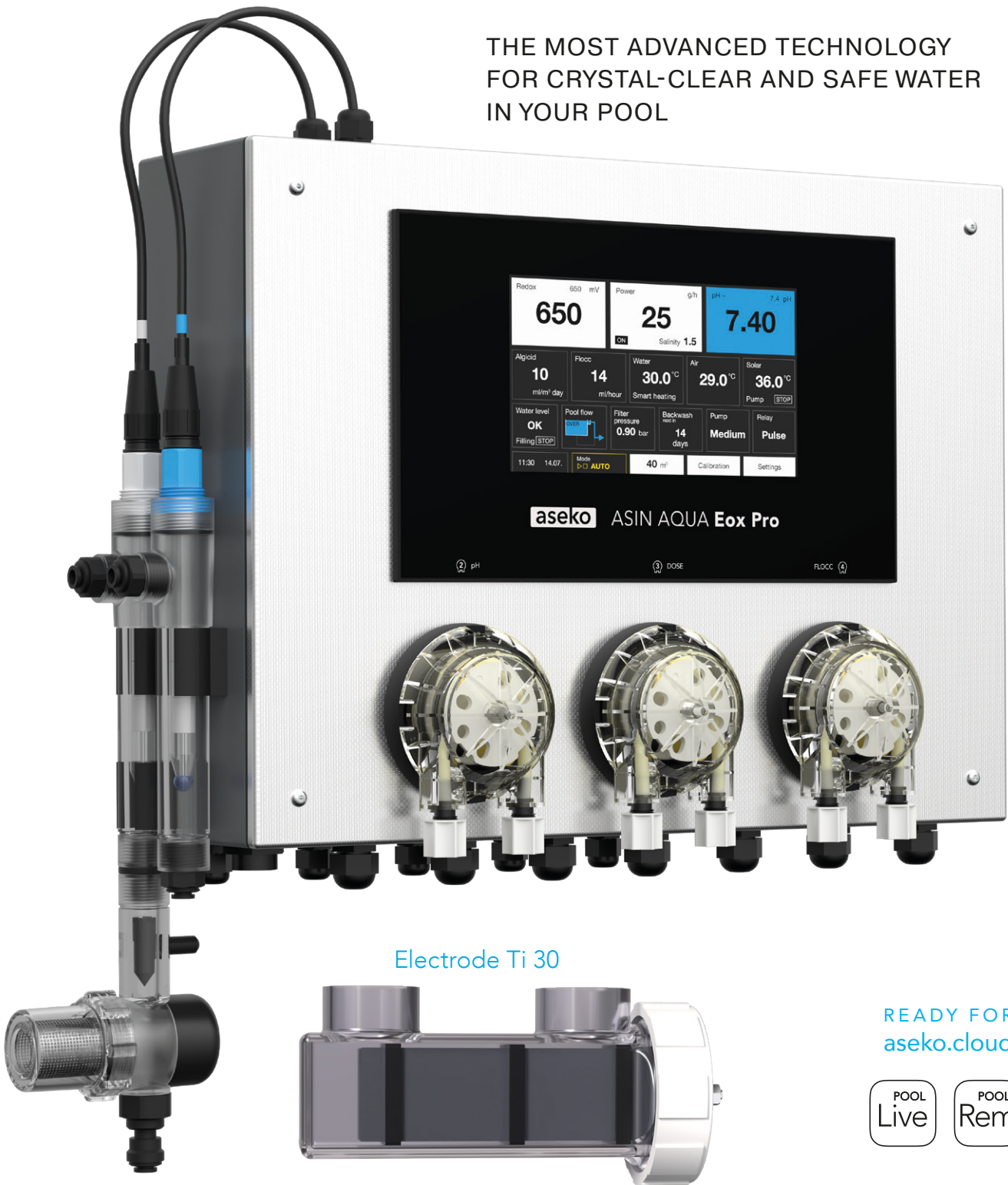

Electrode Ti 30

READY FOR  
aseko.cloud





# General safety information

This user manual contains basic information that should be observed during assembly, start-up, operation, and maintenance. Therefore, this user manual must be read by installers and operators prior to assembly and start/up, and must be accessible to every user of this unit. Additionally, all further safety information in this document must be observed. Read and follow all instructions. In order to minimize the danger of injury, do not allow children to use this product. Non-compliance with safety information can result in hazards to persons, the environment and the equipment. Non-compliance with safety information will result in a forfeit of any potential right to damage compensation.

## Insufficient personnel qualification

Hazards in the event of insufficiently qualified personnel, potential consequence: Injury, heavy material damage.

- The system operator must ensure compliance with the required qualification level.
- Any and all work may only be performed by correspondingly qualified personnel.
- Access to the system must be prevented for insufficiently qualified persons, e.g. via access codes and passwords.

## Potential overdosing of chemical agents

Despite ASIN AQUA Eox Pro comprehensive safety functions, it is possible that a probe failure and other errors could lead to an overdosing of chemical agents. Potential consequence: Injury, heavy material damage.

- Design your installation such that uncontrolled dosage is not possible in the event of a probe failure or other errors, and/or such that uncontrolled dosage is recognized and halted before damage is incurred.
- Uncontrolled overdose of chemicals can cause harm to health and property. Even though the device contains a number of security elements can not be ruled out that in case of failure of the measuring probes, or the whole device may result in overdose of chemical agents. Install the equipment so that uncontrolled overdose of chemicals was not possible and that uncontrolled overdose has been detected in time before causing any harm. It is necessary to use chemicals in such quantities that an overdose will not cause dangerous concentration of chemical agents. Do not use chemicals in too large packages or with too high concentration.

## Gaseous chlorine produced from dosing in standing water if dosing outputs are not closed via the filter pump

If the flow switch is stuck or experiences another error, there is a risk of dosing into standing water. Poisonous chlorine gas can be yielded when sodium hypochlorite and pH minus come together.

## Non compliance with informational text

Not observing informational text may lead to hazards. Potential consequence: gravest degree of injury, heavy material damage.

- Read all informational text carefully.
- Cancel the process if you are unable to exclude all potential hazards.

## Use of new functions

Because of the continued development, a ASIN AQUA Eox Pro unit may contain functions, which are not completely described in this version of the user manual. The use of such new or extended functions without a profound and secure understanding by the operator may result in malfunctions and severe problems. Potential consequence: Injury, heavy material damage.

- Make sure to get a profound and secure understanding of a function and relevant boundary conditions, before you start to use it.
- Check for an updated version of the user manual or additional documentation available for the relevant functions: <http://manuals.asekopool.com>
- Make use of the integrated help function of the ASIN AQUA Eox Pro to get detailed information on functions and their parameter settings.
- In case it is not possible to get a profound and secure understanding of a function based on the available documentation, do not use this function.

## Overdosing if pH value is wrong

If disinfection is enabled before the pH value is stable in the ideal range of 6.8 to 7.5, then it may lead to heavy overdosing of chlorine or bromine. Potential consequence: Injury, heavy material damage.

- **Do not start disinfection with chlorine until the pH value is stable in the ideal range between 6.8 and 7.5.**

## Conditions before using

Make sure you have a newest and updated version of the user manual and other documentation for all functions of the unit. Use and read the integrated help features. In case of not understanding the information about certain features of the unit, do not use these features.

## Handling chemicals for pool water treatment

The chemicals used with the ASIN AQUA Eox Pro must be handled in a safe manner to prevent damage or personal harm. Aseko recommends you always use personal protective safety equipment when handling the pH and chlorine agents. Refer to the Materials Safety Data Sheet (MSDS).



## Important notices for proper functioning.

### **WARNING:**

#### **Never mix pH and chlorine agents.**

Always rinse tubes and valves with clean water during maintenance to prevent mixing.

#### **Never use hydrochloric acid (HCl, muriatic acid, spirits of salt, hydronium chloride, chlorane).**

HCl acid is fuming. Using a chemical based on HCl will cause damage to the device.

**Never install the unit in unventilated technical shafts with high humidity, as this can severely damage electronic components, especially the display. Damage caused by high humidity will not be accepted as a warranty claim.** If the ASIN AQUA Eox Pro is in a high-humidity and low-temperature environment (e.g., garden house), keep the device permanently ON. This helps maintain a higher internal temperature, significantly reducing humidity inside the unit. The same applies when storing the unit during winter.

#### **Installation must be protected by a residual current device (RCD).**

#### **The pool and pool technology must be properly grounded.**

#### **CLF Probe Calibration:** Calibration can only be done when the pH is stable in the range of **6.8–7.5**.

After changing the electrolyte, wait at least **1 hour**, but ideally **24 hours**, to allow the signal to stabilize before proceeding with calibration.

#### **Never use stabilizers with cyanuric acid in ASIN AQUA Eox Pro devices.**

Cyanuric acid forms a chlorine-cyanurate complex, which rapidly decreases the disinfecting power of chlorine and makes it impossible to measure with a free chlorine probe. Be aware that some chlorine tablets contain cyanuric acid. Ensure there is no cyanuric acid in your pool.



**MAX POOL VOLUME**  
70 m<sup>3</sup>

## ASIN AQUA Eox Pro

A high-performance control system for treating low saltwater swimming pools. Aseko probes ensure accurate pH and disinfection measurement. Controlled electrolysis ensures stable water disinfection. Thanks to new power supply technology designed specifically for low salt pools and an improved Ti30 electrode surface, the device can produce up to 25 g of free oxygen radicals and chlorine disinfection mixture per hour at a salt concentration of 1.5 g/l.

Regulation of pH is provided by a built-in peristaltic pump, controlled by an intelligent algorithm with integrated safety features. Water care is further enhanced by time-based algicide or stabiliser dosing and, newly, continuous and slow flocculant dosing. The system is equipped with advanced Pool Technology Management features that provide maximum automation of pool technology.

An online monitoring via the Aseko LIVE mobile app and the aseko.cloud web platform, and also remote control using the Aseko REMOTE app.

## Water treatment

### Electrode Ti30

The innovative power supply technology and an improved Ti30 electrode surface boost the production up to 25 g of free oxygen radicals and chlorine disinfection mixture per hour at a salt concentration of 1.5 g/l.

### Chlorine regulation

Accurate measurement by the Redox probe for salt in combination with the control electrolysis algorithm maintain the required value of disinfection.

### pH control and dosing

Accurate measuring by pH probe long-life in combination with the dosing algorithm assures the required water quality.

**Use of hydrochloric acid is strictly forbidden.**

### Daily dosing of algicide or stabilizer

A daily dose of algicide or stabilizer ensures perfect water quality in all conditions. Use Aseko ALGICID during periods of higher humidity, or Aseko ACO Stabilizer in intense sunlight and high temperatures.

### FLOC+C

FLOC+C contains flocculation and coagulation components. Its continual dosing improves filtration capability of removing even the smallest impurities.



# Pool technology management

## Filtration Time Control

Daily, automatic start of the filtration system in 4 individually pre-set periods.

## Water Level - Refilling

### Pressure level sensor.

Water level can be monitored by optional **pressure level sensor**. System can be programmed to control four different water levels at your pool and switch the water refilling or automatically use the excessive water for filter backwash.

**Float level detector** controls two levels for switching the automatic water refilling.

## Filter Backwash

The system can control the filter backwash time interval and periods this function requires an optional **5-way Besgo valve**.

## Filter disinfection

ASIN AQUA Eox Pro disinfects the filtration system during filter backwash.

## Smart Heating Control

The system is equipped by intelligent control of pre-set water temperature. It can switch and control the heating (**solar heating, electrical heating, gas heating, heat exchanger**) by logic of integrated smart heating functions.

## Winter mode

The Winter mode ensures the pool remains at a safe temperature during cold weather conditions.

## Variable speed pump control (VS pump)

In the settings, select the type of your variable speed pump. ASIN AQUA allows to use 4 speeds:

- Speed 0 (OFF)
- Speed 1 (LOW)
- Speed 2 (MEDIUM)
- Speed 3 (HIGH)

## Switching BOTTOM / OVERFLOW

The ASIN AQUA Eox Pro system allows you to precisely configure whether you want to use the overflow or bottom drain in your pool. In auto mode, there are four periods where you can individually select BOTTOM or OVERFLOW for each period.

This function requires optional **3-way Besgo valve**.

## Pool cover position (relay closed)

If the pool cover is closed during the set TIMER times, the speed of the VS pump will automatically change to 1 (LOW).

## Pool cover movement (relay closed)

When the cover is moving, ASIN AQUA automatically switches off the filtration pump.

## Control by External touch display

ASIN AQUA Eox Pro can be monitored and controlled by external touch display this function requires an optional **External touch display**.

## Mode settings

Six adjustable automatic modes for easy pool control.

## Programmable relays

ASIN AQUA Eox Pro has one integrated programmable relay to control an extra accessory. Also brings the possibility to connect optional **RL module** (relay module) to connect 4 extra relays.

## Solar heating control

ASIN AQUA Eox Pro monitors the temperature of solar panels. When solar panels reach a set threshold, the water is automatically redirected to the solar panels. This function requires an optional **4-way Besgo valve**.

# What do you receive in your box

Device  
ASIN AQUA Eox Pro



Water thermometer with housing #13066

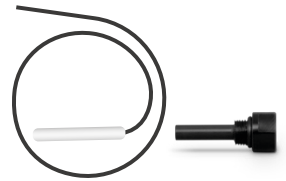

Probe housing 2 pcs  
#13013

Peristaltic pumps #13024

Flow detector with filter  
and salinity measurement  
#13326-1

Electrode Ti 30



Redox probe for SALT #12113

pH probe Long Life #12012



Water valves 2 pcs  
#12006

Injection valve 2 pcs  
#12005

Suction kit for 20l canister  
#13415

PE Tube 1/4 (6,35mm) 20m -  
transparent #13278



Mounting rail  
#13430

Dowels and screws  
#12125



# Available optional accessories

EXT Eox Pro  
#13291



Pressure-type level sensor  
#12086



External touch display  
#12048

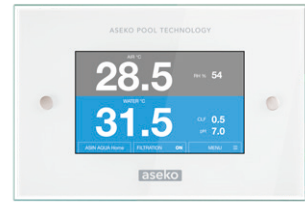

Injection manifold d50/DN63  
4x 1/4" #13395



Coagulation mixer d 50, L 195 mm  
#30001

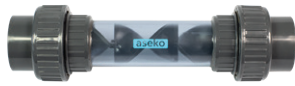

Digital Photometer Aseko  
#13449



pH 7.00 Buffer #12065  
Redox Buffer #12091



BESGO 5-way  
#83103  
BACKWASH



BESGO 3-way  
#83130  
OVER /BOTTOM



BESGO 4-way  
#83150  
SOLAR



Air thermometer  
#13193

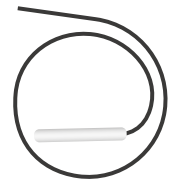

# ASEKO original chemical solution

## 20 l or 5 l volume

pH MINUS #12130 or pH PLUS #12120



ALGICID #12156



FLOC+C #12139



## Volume 10 kg

SALT PURE 10kg #13344



BALANCER #13345



MAGNESIUM #13346



## Bottle 1 kg

SUPER CHLOR #13120



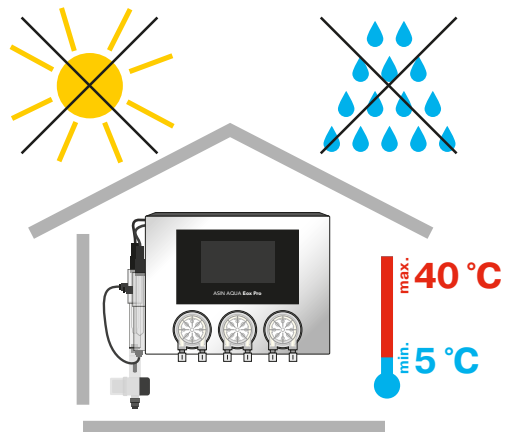

## ASIN AQUA Eox Pro Installation

The ASIN AQUA Eox Pro must be operated in indoor environment with a temperature range of +5 to +40 °C, and the relative humidity must not exceed 70%. Direct sunlight, high humidity, and dust may damage the ASIN AQUA Eox Pro.

- Before installing, ensure that pool water is chemically clean and without dirt.

Install the mounting rail and attach the ASIN AQUA Eox Pro to the wall. Choose a location with a free space of at least 40 cm in all directions, and a height above the floor must not be higher than 150 cm.

- The vertical distance between ASIN AQUA Eox Pro and the bottom of containers must not exceed 2m.
- The maximum distance from injection valves to peristaltic pumps must not exceed 8m.

**RECOMMENDATION:** Install the ASIN AQUA Eox Pro so that even in case of leakage of chemicals from the pumps or pipes, there is no damage to other equipment or spillage on the floor. Use drip trays.

Do not install any other devices under ASIN AQUA Eox Pro.

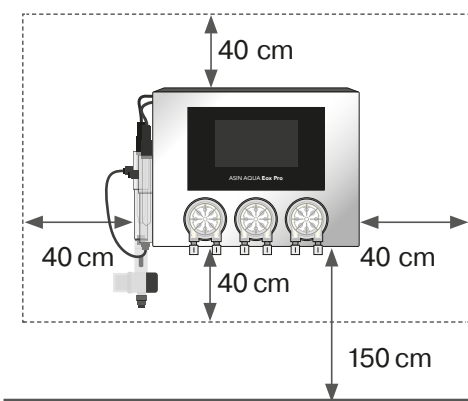

Wall bracket

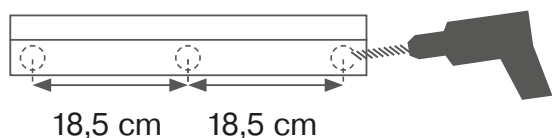

### **WARNING:**

**Never install the unit in unventilated technical shafts with high humidity, as this can severely damage electronic components, especially the display. Damage caused by high humidity will not be accepted as a warranty claim.** If the ASIN AQUA Home Pro is in a high-humidity and low-temperature environment (e.g., garden house), keep the device permanently ON. This helps maintain a higher internal temperature, significantly reducing humidity inside the unit. **The same applies when storing the unit during winter.**

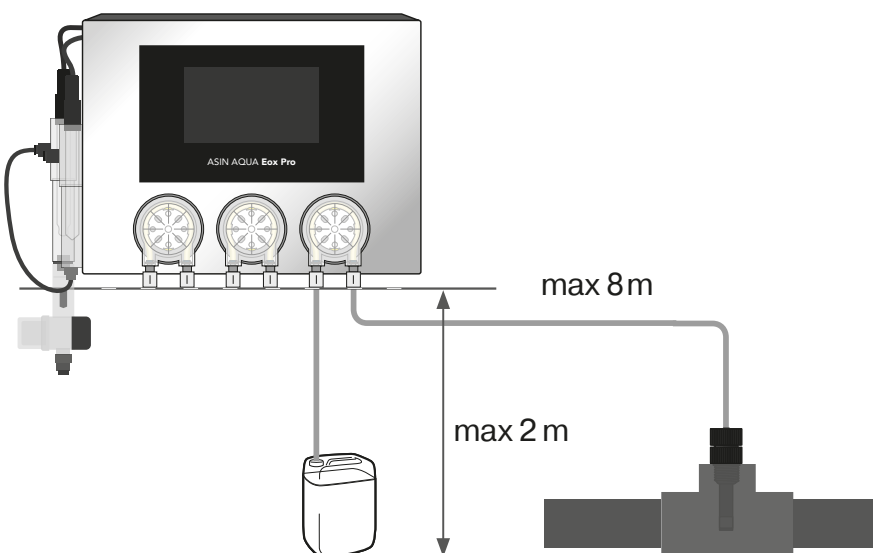

# Installing the Probes

1. Carefully insert the pH, CLF or REDOX probe into the housing.
2. Hand tighten or use the plastic wrench socket for probes.
3. Connect the CLF or Redox probe with yellow marked cable and pH probe with blue marked cable.

After probes have been inserted, slightly tightened and connectors have been connected, ASIN AQUA is ready for connection to the water system of your pool.

**WARNING:** Only hand-tighten the probes or use the plastic probe wrench. Do not use pliers or a steel wrench. The tightening torque is 3 Nm.

## Step 1: Installation of pH probe

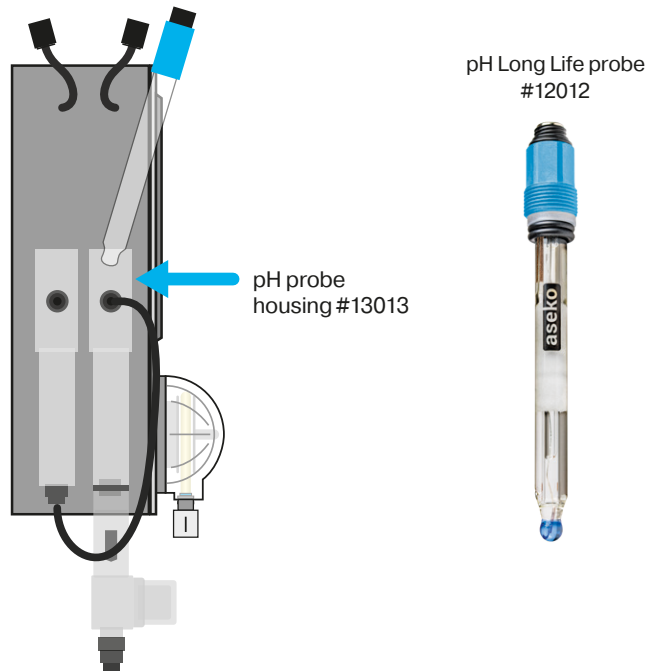

## Step 2: Installation of Redox probe

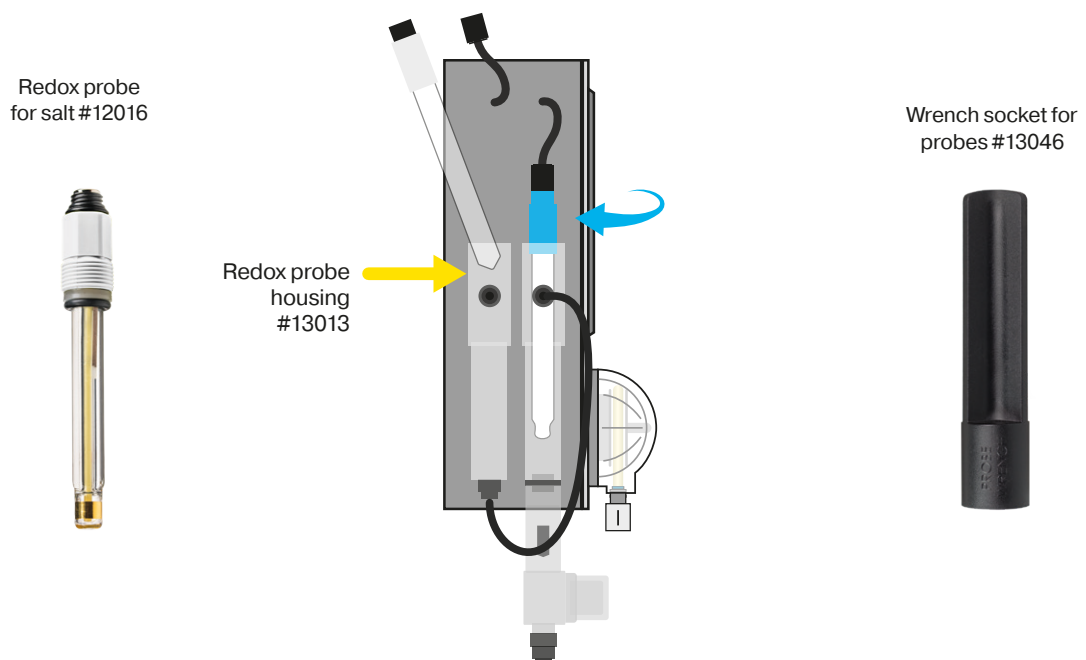

# Connection of electrode Ti 30

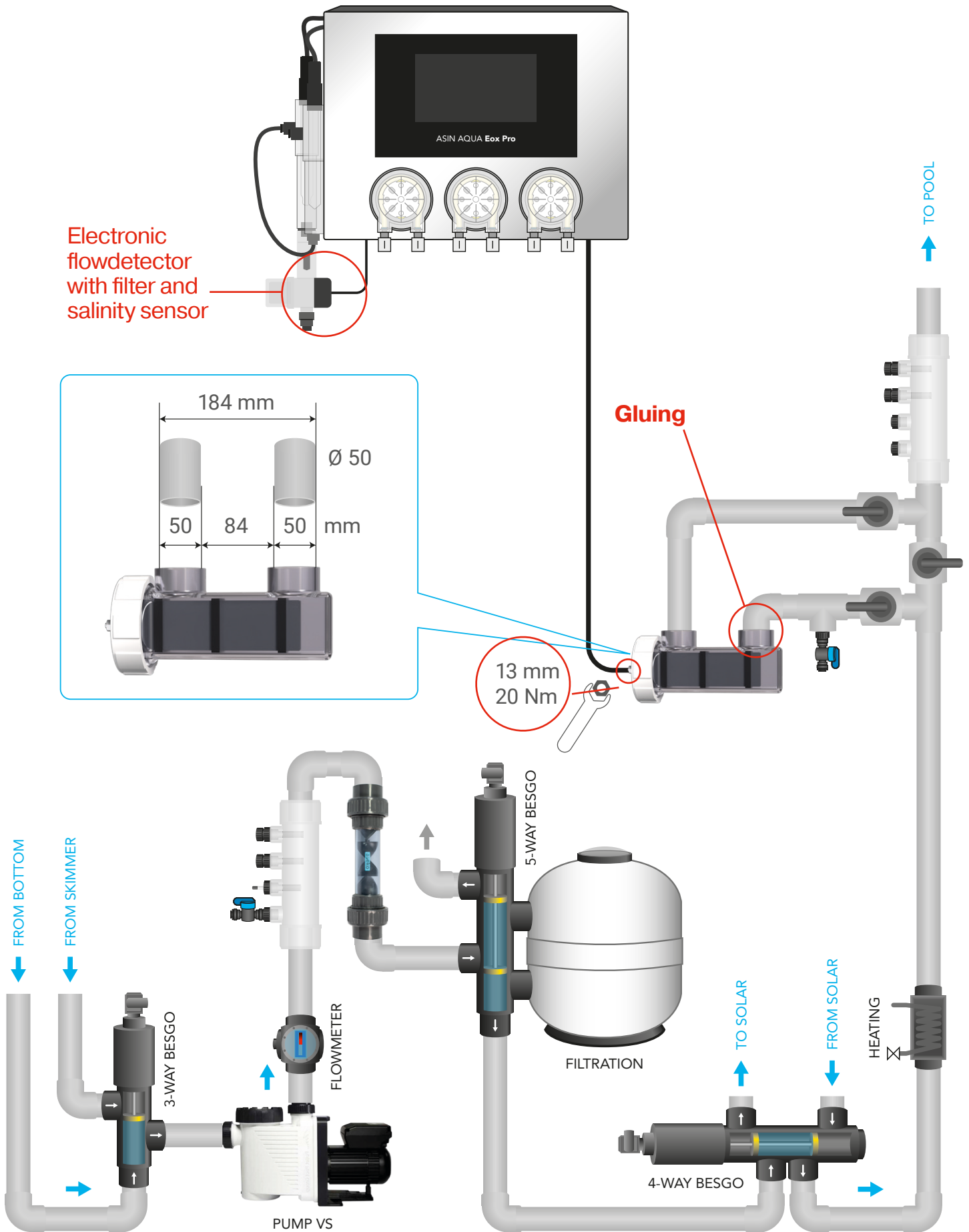

## Connection of electrode Ti 30

Electrode Ti 30



One of the key components of the ASIN AQUA Eox Pro device is the titanium electrode Ti 30 with a ruthenium-iridium surface, which enables electrolysis of pool water and chlorine generation.

Place the electrode in the filtration circuit branch according to the diagram on the previous page. Insert a valve between the inlet and outlet pipes of the branch to allow circulation in case of electrode shutdown and to close the branch if needed. The recommended position for the electrode is at site 10. It is necessary to place the electrode so that all titanium plates are evenly submerged in water. Once the branch is connected to the system, you can connect the electrode power cables from the ASIN AQUA Eox Pro unit.

**RECOMMENDATION:** Install the electrode upside down to ensure that the electrode will be during its operation fully flooded.

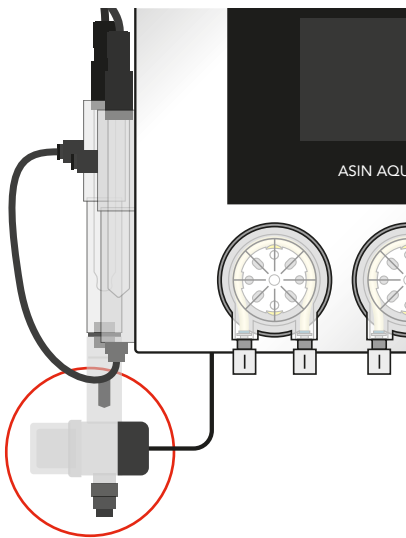

Salinity measuring unit

## Salinity measuring unit

The salinity sensor is part of the measuring water filter.

# Pool Water Connection

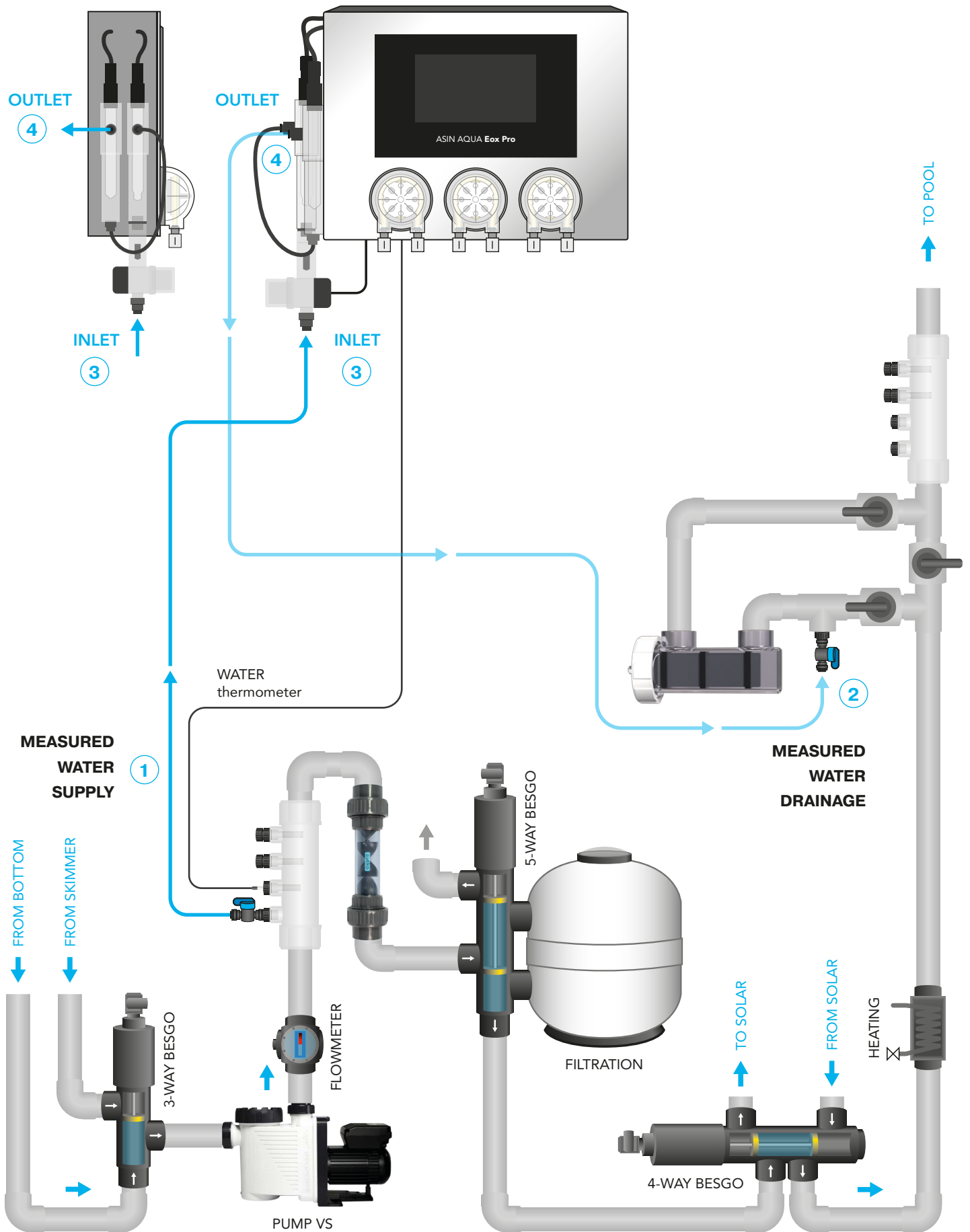

# Pool Water Connection

Screw the **measuring water valve** in the injection manifold 4x 1/4".  
**Tighten the measuring water valve into the injection manifold by hands only. Do not use pliers or other tools.**

- 1 Connect the **MEASURED WATER SUPPLY** to the pipe **behind the pump, and before the filter and before the electrode.**
- 2 Connect the **MEASURED WATER DRAINAGE** to the pipe behind the filter and heating, ideally into the electrode bypass. This ensures that when the bypass is closed, no measured water flow is detected, and electrolysis automatically shuts off.

To connect the measured water to the ASIN AQUA Eox Pro use PE tube 1/4 "(6.35 mm) #13278, which is part of the packaging.

## WARNING

Cut the PE tube at an angle of 90° to ensure tight joints. The cut must be clean. Use special pliers #13325 to cut plastic tubes. Do not use common scissors or knives!

The measured water is easily connected to ASIN AQUA Eox Pro using the **Speedfit** push-in fitting.

**CONNECTION** Push the connecting pipe into the Speedfit fitting and pull out the hose to secure.

**DISCONNECT** push and hold the Speedfit round collet and pull out the connecting pipe.

- 3 **INLET** of the measured water to the ASIN AQUA Eox Pro  
Connect the tube to the bottom Speedfit of the measured water filter.
- 4 **OUTLET** of the measured water from ASIN AQUA Eox Pro  
Connect the tube to the side Speedfit on the probe housing and back to the measured water drainage.

Once connected, ASIN AQUA Eox Pro is ready to measure disinfectant content and pH value in your pool.

## WARNING

**Chlorine production must be stopped if water is not flowing through the electrode.**

**Always install the electrode on a bypass. It is necessary to connect the outlet of the measured water to the bypass in front of the electrode.**

Connecting the measured water outlet before the electrode in the bypass will cause a "No Flow to Probes" warning if the bypass is clogged, which stops the chlorine production

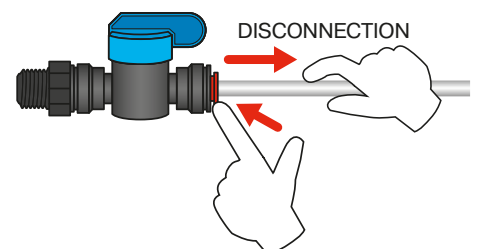
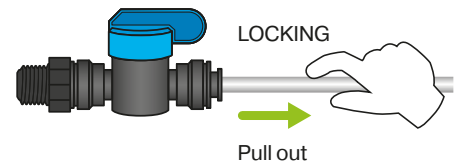
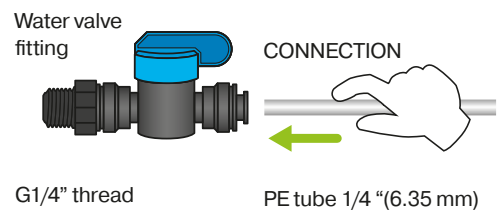
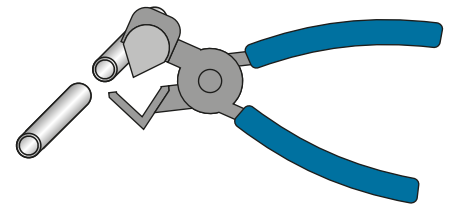
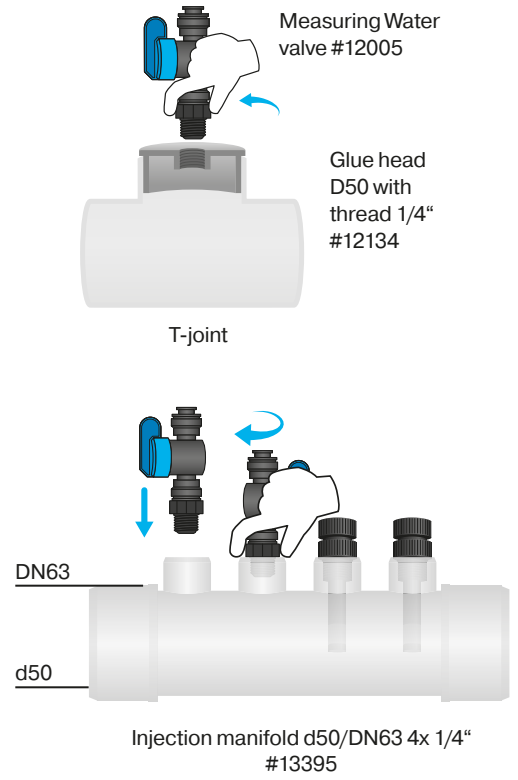

# Pool Chemicals Connection

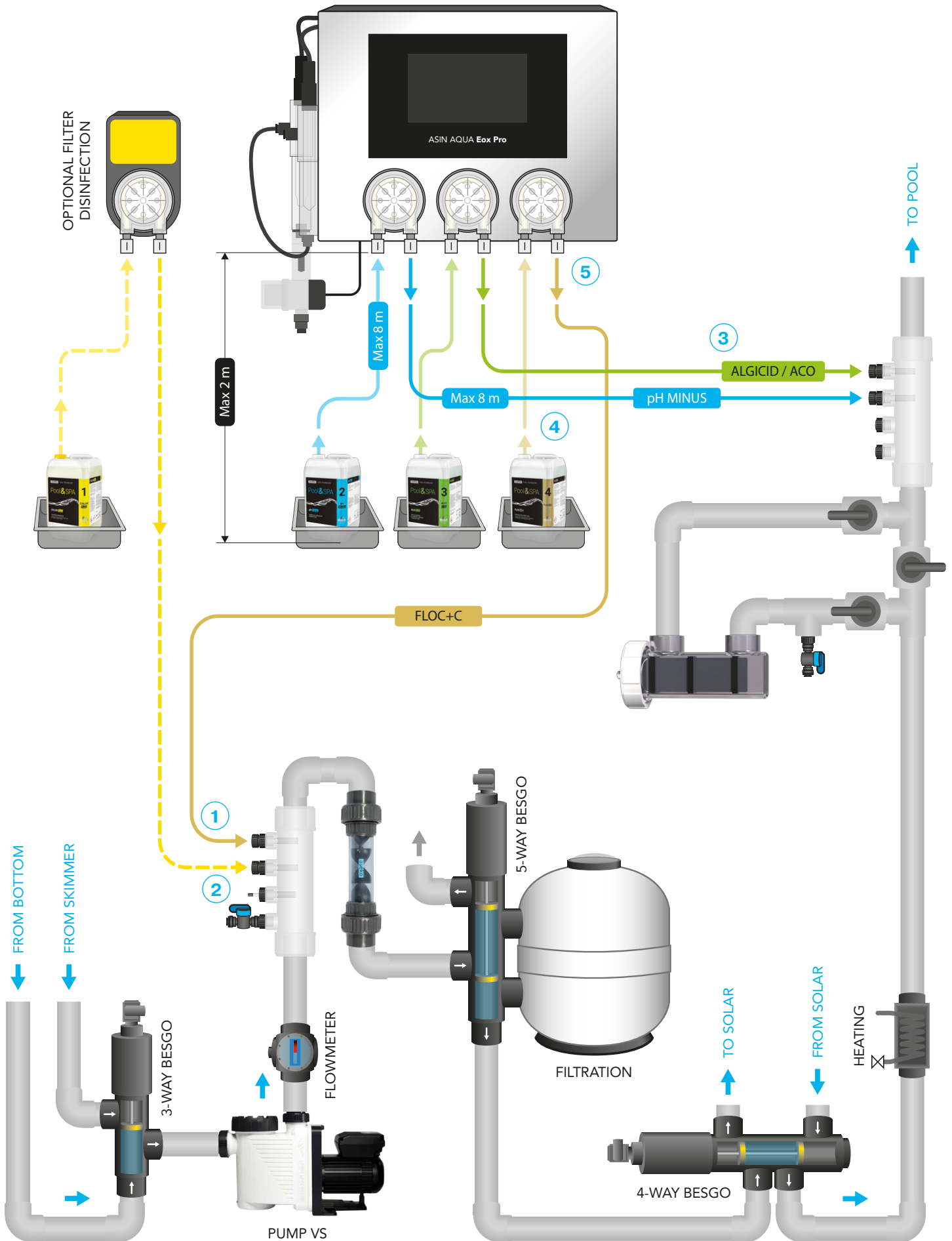

# Pool Chemicals Connection

Screw the **injection valve** in the injection manifold 4x 1/4".  
**Tighten the valve by hands only. Do not use pliers or other tools.**

- 1 Connect the **FLOC+C INJECTION VALVE** to the pipe **before the coagulation mixer and before the filter and after the MEASURED WATER SUPPLY**.
- 2 Connect the **FILTER DISINFECTION INJECTION VALVE** to the piping **before the besgo 5 way valve and before the filter and after the MEASURED WATER SUPPLY**.
- 3 Connect the **ALGICIDE or CHLOR PURE, pH INJECTION VALVE** to the pipe **behind the filter and behind the MEASURED WATER DRAINAGE**. Connect injection valves in this order to prevent formation of lime scale.

To connect reagents from cans to the ASIN AQUA Eox Pro and from the ASIN AQUA Eox Pro to the injection valves use PE Tube 1/4" (6.35 mm) #13278, which is part of the packaging.

## WARNING

Cut the PE tube at an angle of 90° to ensure tight joints. The cut must be clean. Use special pliers #13325 to cut plastic tubes. Do not use common scissors or knives!

- 4 **CANISTER CONNECTION** Use the Suction kit for 20l canister #13415. Put the PE tube through the cap so it ends right over bottom of the canister.
- 5 **PUMP CONNECTION** Connect the can with the left (suction) connector of the pump using a PE tube from the can.
- 6 **INJECTION VALVE CONNECTION** Pass the tube through the injection valve nut, connect the tube onto the injection valve and tighten the nut firmly by hand. Connect the tube from injection valve with the right (discharge) connector of the pump.

## WARNING

**NEVER CONNECT pH minus reagent to disinfection pump or disinfectant to pH pump!** In the case of a cross-connection, after ten doses ASIN AQUA Eox Pro displays an error message. Repair the piping installation and then you can continue to operate your ASIN AQUA Eox Pro.

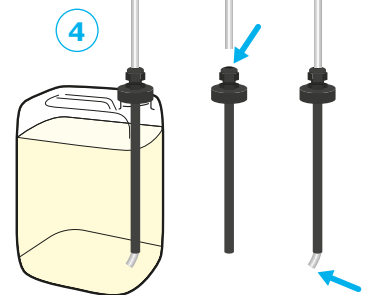
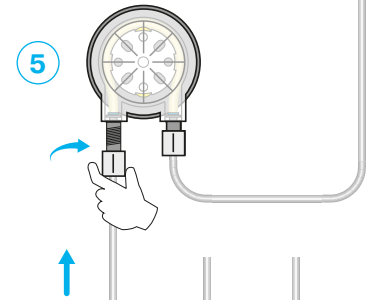
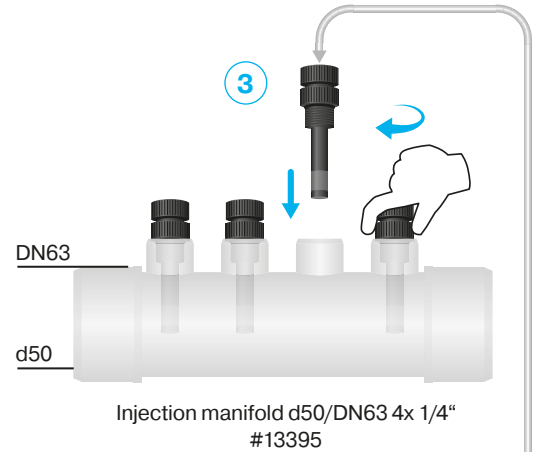

Suction kit for 20l canister #13415

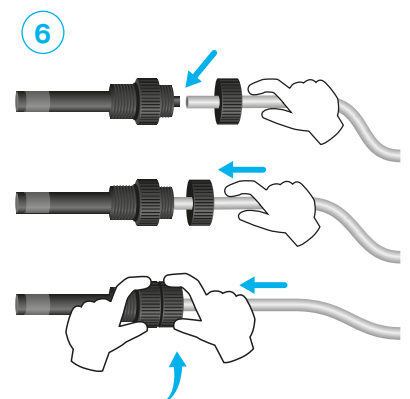

## MAX POOL VOLUME

70 m<sup>3</sup>

## System start-up

### Salting the pool water

Chlorine generating depends on the salt concentration and water temperature. The lower the temperature, the lower the chlorine production. You can boost the electrolyzer by increasing the salt concentration. 1 kg of salt per cubic meter of water can increase the electrolysis power for about 20%. Maximum salt concentration is 4 kg/m<sup>3</sup>.

Exceeding the recommended salt concentration will overload power supply components of the ASIN AQUA Eox Pro. The main unit is protected by maximum current control circuit. Overload automatically disconnect the power supply. Thin the salt concentration before switching the power supply again. Never use lower salt concentration than 1.5g/l - this expressively reduce the electrode lifetime. Higher salt concentration is very corrosive and may cause corrosion of pool equipment.

### Disinfection is expressively affected by following:

- temperature
- intensity of sun shining
- quantity of person using the pool
- weather conditions
- organic pollution

**Maximal recommended salt concentration**

**1.5 kg/m<sup>3</sup>**

**Minimal recommended salt concentration**

**1.0 kg/m<sup>3</sup>**

### Instructions to operate the electrolyzer:

The amount of chlorine produced depends only on the concentration of salt in the pool water.

Never switch on the ASIN AQUA Eox Pro before the salt in the water is completely dissolved.

Electrode connection to ASIN AQUA Eox Pro must be done only when disconnected power supply.

### Important water parameters

Parameter	Recommended value	Impact on water quality
pH	7.2 - 7.4	Affects the effectiveness of disinfection
Salt content	1.0 - 1.5 g/l	Affects electrode performance
Water hardness	max. 350 ppm	Causes electrode clogging
iron and manganese content	max. 0.1 mg/l	Causes a brown-green discoloration of the water
Cyanuric acid	0ppm	Cyanuric acid greatly diminish the effectiveness of chlorine, making it impossible to measure and control.



**Salt to be used**

Do not use rock salt. All additives may cause electrode lifetime shortening.

ASIN AQUA Eox Pro is designed to electrolyze water with 1.5 kg/m<sup>3</sup> salt concentration.

Electrode may be damaged at lower salt concentrations than 1.0 kg/m<sup>3</sup>. It is necessary to provide routine salt concentration control. The salt concentration changes only little during electrolysis. The main change in salt concentration is caused by filter backwashing, splashing and strong rains.

Following table displays salt quantity in kg necessary to increase the concentration to 1.5 kg/m<sup>3</sup>.

SALINITY kg/m <sup>3</sup>	POOL VOLUME									
	10 m <sup>3</sup>	15 m <sup>3</sup>	20 m <sup>3</sup>	25 m <sup>3</sup>	30 m <sup>3</sup>	35 m <sup>3</sup>	40 m <sup>3</sup>	50 m <sup>3</sup>	60 m <sup>3</sup>	70 m <sup>3</sup>
	Amount of salt in kg that needs to be added to increase its concentration to 1.5 kg/m <sup>3</sup>									
0	15	22.5	30	37.5	45	52.5	60	75	90	105
0.25	12.5	18.75	25	31.25	37.5	43.75	50	62.5	75	87.5
0.5	10	15	20	25	30	35	40	50	60	70
0.75	7.5	11.25	15	18.75	22.5	26.25	30	37.5	45	52.5
1	5	7.5	10	12.5	15	17.5	20	25	30	35
1.25	2.5	3.75	5	6.25	7.5	8.75	10	12.5	15	17.5
1.5	0	0	0	0	0	0	0	0	0	0

# Electrical Connection

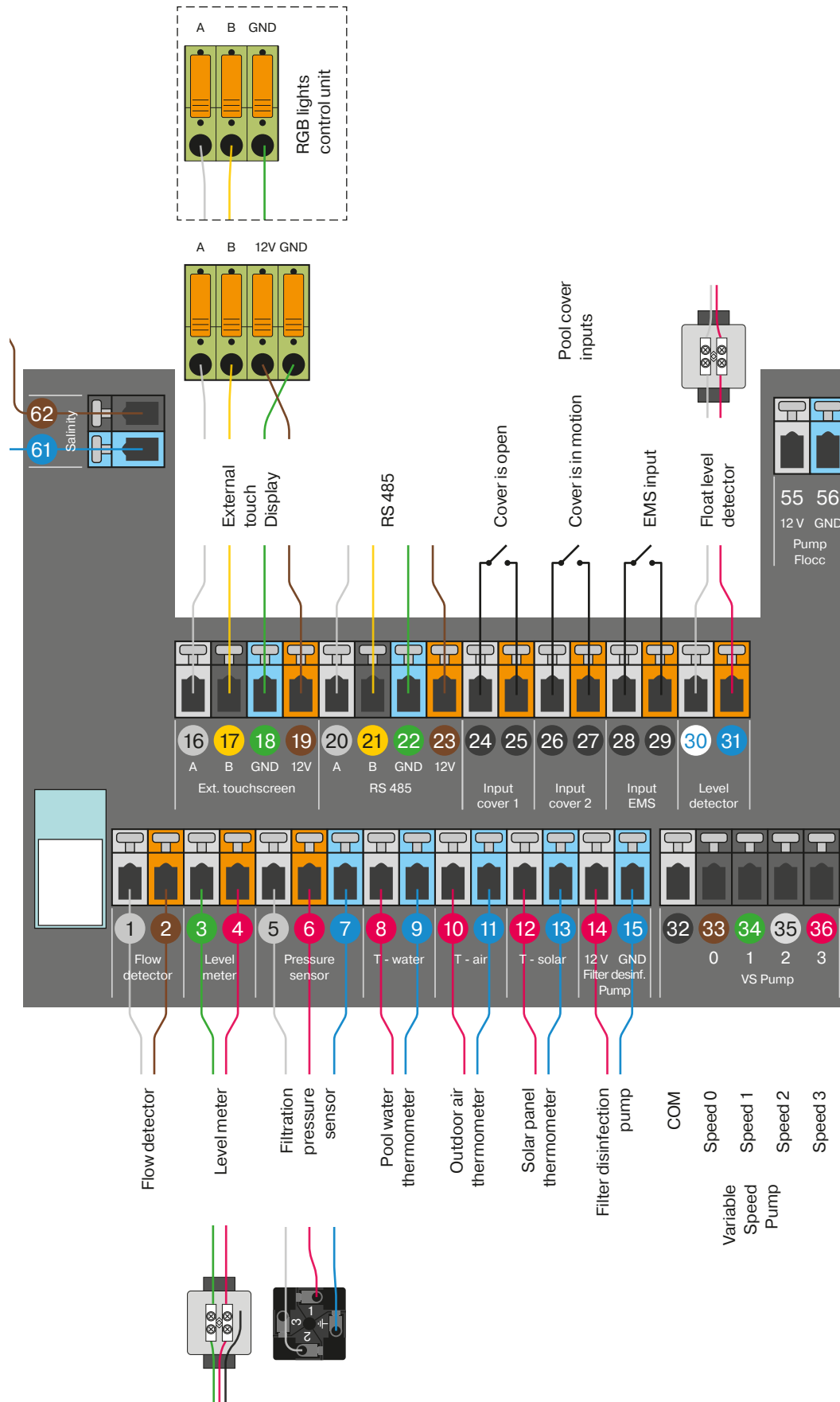

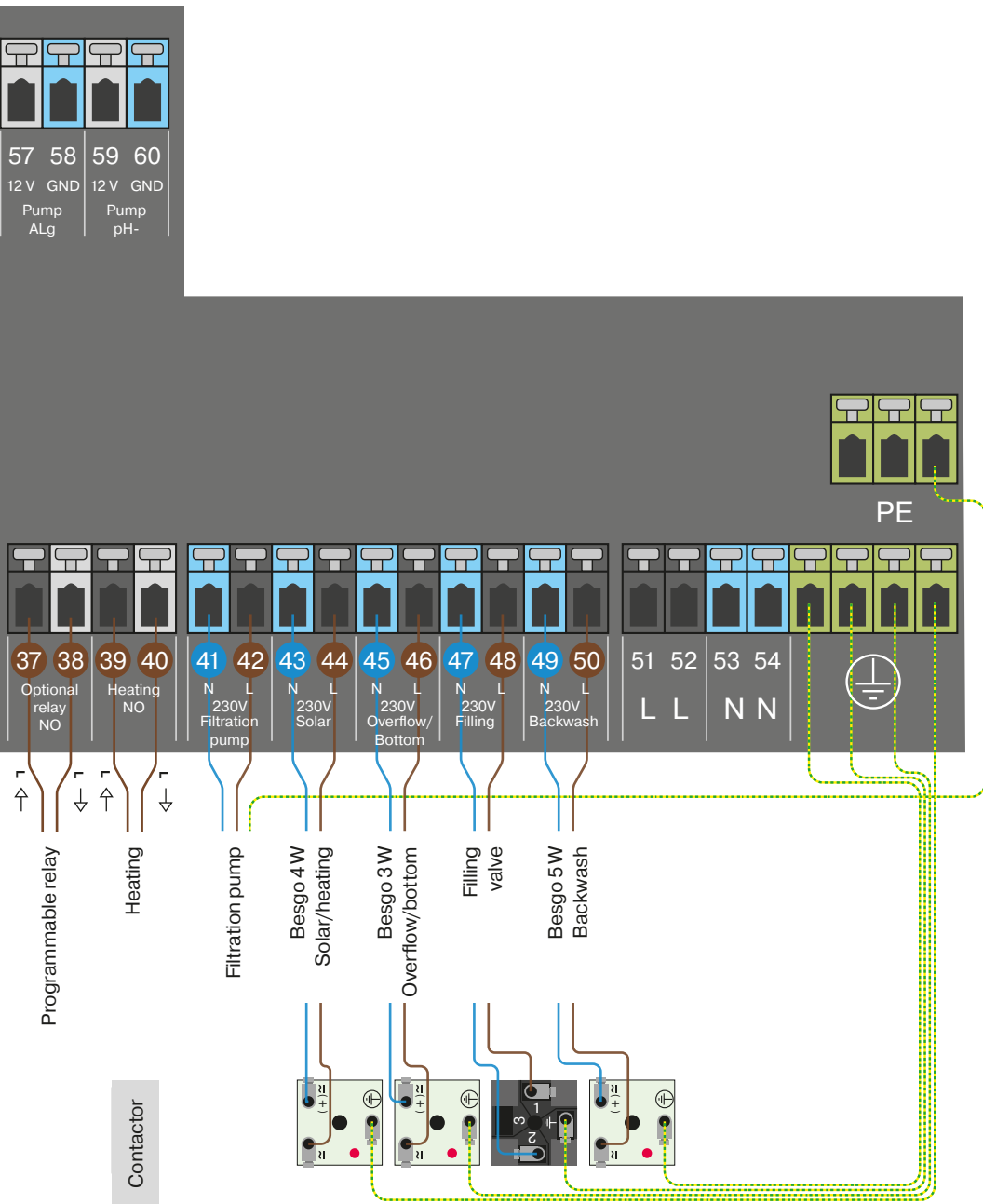



**Installation must be protected by a residual current device (RCD).**

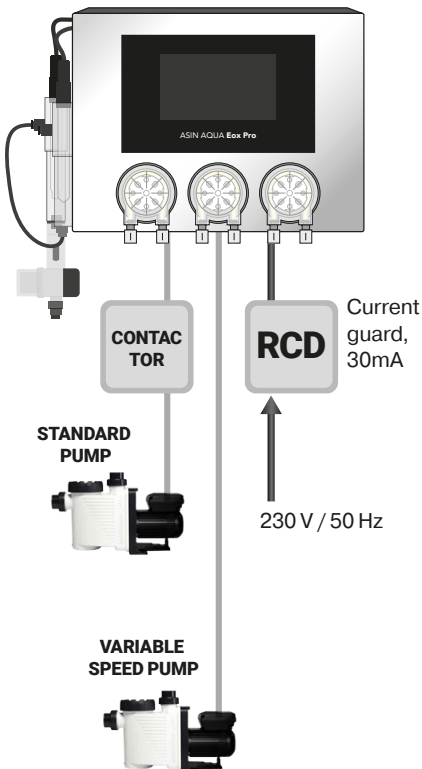

## Power Supply

### Connection to the mains:

1. Leave the mains switch in the OFF position.
2. Connect the 230 V/50 Hz mains cable to ASIN AQUA Eox Pro.  
The mains socket outlet must be protected by a residual current device (RCD).
3. Change the mains switch over to the ON position.

After Device has been switched on, the display will come on and the ASIN AQUA Eox Pro starting screen will appear.

### Disconnection from the mains:

1. Change the mains switch over to the OFF position.
2. Disconnect the ASIN AQUA Eox Pro mains cable from the 230 V/50 Hz.

**WARNING:** If Device is used in the manner different from that specified by the manufacturer, protection provided by Device may get damaged.

Power supply	230 V/50 Hz
Power consumption	24 VA
Fuse	T1 A; T8 A
Over-voltage category	II
Ingress protection	IP40
Operating temperature	+5 to +40 °C
Weight	6.7 kg
Installation	wall mounted
Measured water pressure	max. 1 bar (must not be vacuum)
Dimensions	430 x 330 x 160 mm

# Filtration pump

## WARNING

Always check the connection according to the current user manual of your pump manufacturer.

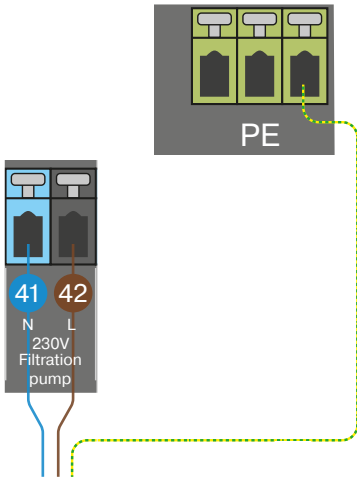

### 1) Filtration pump

Connect the filtration pump to outputs **41, 42** and **PE**.

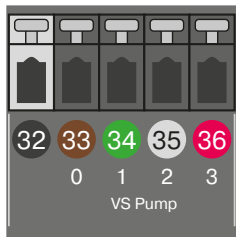

2

### 2) Variable speed filtration pump

Connect to outputs **32 to 36**, connection depends on the type of variable pump.

Speed	TYP A				TYP B				TYP C						
	COM	S1	S2	S3	STOP	COM	S1	S2	S3	S4	COM	S1	S2	S3	STOP
n1	ON	OFF	OFF	OFF	OFF	n1	ON	OFF	OFF	OFF	n1	ON	OFF	OFF	OFF
n2	OFF	ON	OFF	OFF	OFF	n2	OFF	ON	OFF	OFF	n2	OFF	ON	OFF	OFF
n3	OFF	OFF	ON	OFF	OFF	n3	OFF	OFF	ON	OFF	n3	OFF	OFF	ON	OFF
S	OFF	OFF	OFF	ON	OFF	S	OFF	OFF	OFF	ON	S	ON	ON	ON	OFF

Relay status

2

## TYPE A

### SPECK

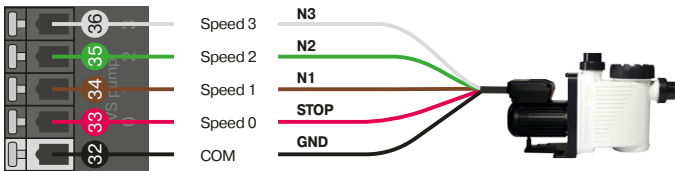

### UWE EO PM

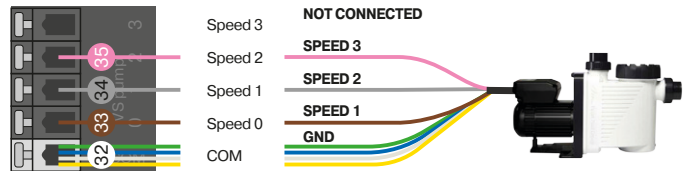

### AQUAGEM INVERPRO

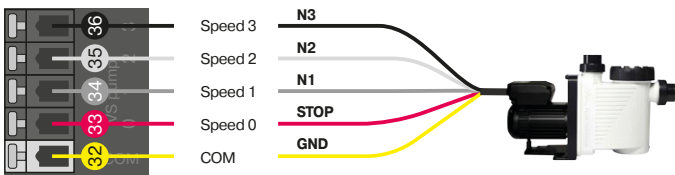

### HAYWARD KS Evo VS

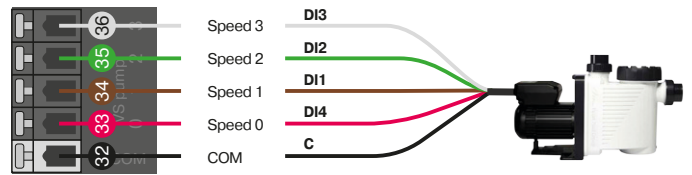

## TYPE B

### PENTAIR

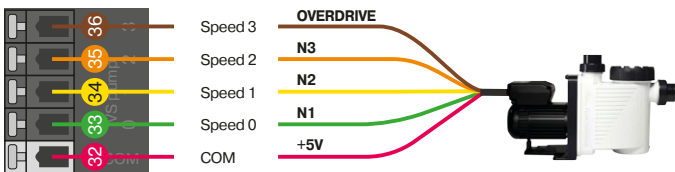

### DAB E.SWIM - E.PRO

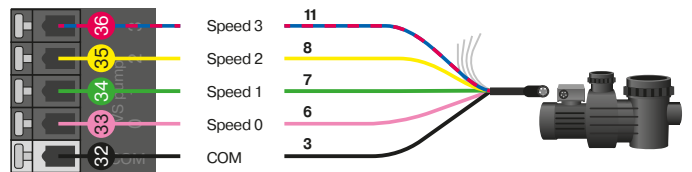

## TYPE C

### HAYWARD (older type)

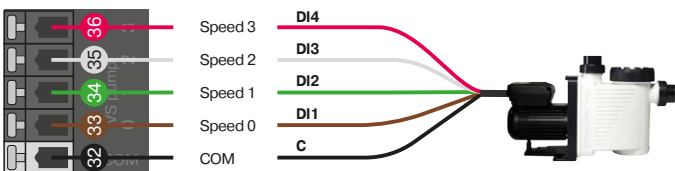

# Equipment connection

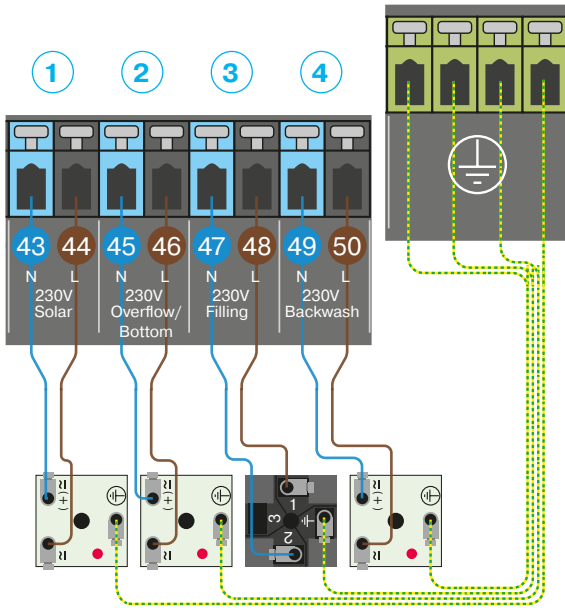

## 1) Solar (4 way Besgo valve)

Connect to the 230 V outputs **43** (blue N) and **44** (brown L).

## 2) Overflow/Bottom (3 way Besgo valve)

Connect to the 230 V outputs **45** (blue N) and **46** (brown L).

## 3) Filling solenoid valve

Connect to the 230 V outputs **47** (blue N) and **48** (brown L).

## 4) Filter backwash (5 way Besgo valve)

Connect to the 230 V outputs **49** (blue N) and **50** (brown L).

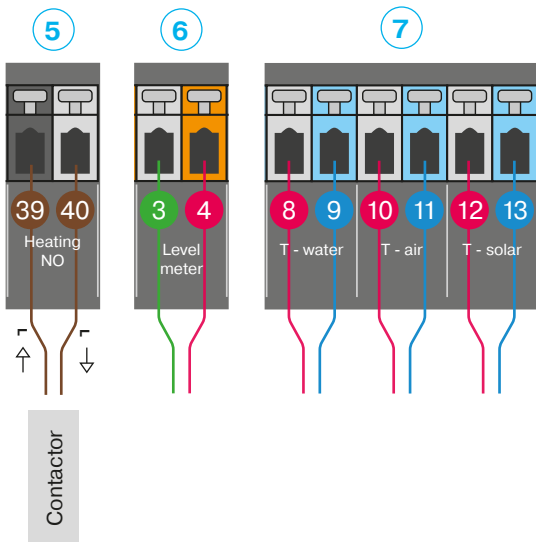

## 5) Heating

Connect to the non potential outputs **39** and **40**.

To connect the heating system, it is recommended to use a contactor.

## 6) Water level meter (pressure)

Connect to the green wire to the terminal **3** (green) and red wire to the terminal **4** (red).

## 7) Thermometers

T – water connect to the terminals **8** (red) and **9** (blue).

T – air connect to the terminals **10** (red) and **11** (blue).

T – solar connect to the terminals **12** (red) and **13** (blue).

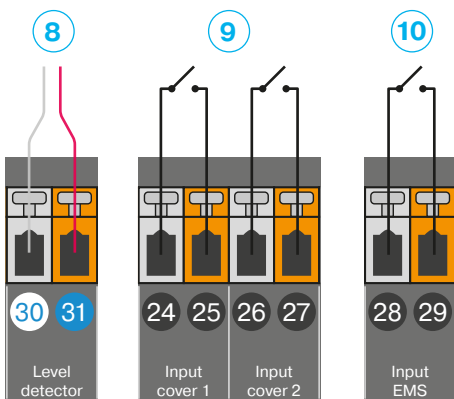

## 8) Float level detector

Connect the logical input to outputs **30** and **31**.

## 9) Cover position detection

Connect the logical input for closed cover detection to outputs **24** and **25**, and connect outputs **26** and **27** to detect cover movement.

## 10) Input EMS (Energy Management System)

Connect the logical input to outputs **28** and **29**.

# Touch screen description

Required Value

Measured value

Electrolyser status ON-dosing

Current mode

Pool volume

Calibration menu

Settings menu

Detailed description: This is the main dashboard screen. It features a grid of widgets. At the top, there are three large widgets: 'Redox' with a measured value of 650 mV and a required value of 650 mV; 'Power' with a measured value of 25 g/h and an 'ON' status; and 'pH' with a measured value of 7.40. Below these are five smaller widgets for 'Algicide' (10 ml/m³ day), 'Flocc' (14 ml/hour), 'Water' (30.0 °C with 'Smart heating' status), 'Air' (29.0 °C), and 'Solar' (36.0 °C with a 'STOP' button). The next row includes 'Water level' (OK), 'Pool flow' (OVER with a blue arrow), 'Filter pressure' (0.90 bar), 'Backwash' (14 days), 'Pump' (Medium), and 'Relay' (Pulse). The bottom row shows the time (11:30 and 14:07), a 'Mode' selector (AUTO), 'Pool volume' (40 m³), 'Calibration' menu, and 'Settings' menu.

Current mode

Switch the mode

Decrease the value

Increase the value

Back

Detailed description: This screen is for temperature and scheduling. At the top, there are mode selection buttons: PARTY, AUTO (selected), ECO, WINTER, OFF, and ON. Below is a 'Water °C' widget with a value of 28.5 and '+'/'-' buttons. A checkbox 'Temp. is superior to filtration' is checked. The main section is a scheduling table with columns for 'START', 'STOP', 'SPEED', and 'FLOW'. The rows are Morning, During day, Afternoon, and Night, each with time and speed/flow settings. A 'Back' button is at the bottom left.

Name

Function activated

Back to the previous screen

Displays info for the current screen

Previous page

Current page / number of pages

Next page

Detailed description: This is the 'Settings' screen. It shows system information (Serial No: 110013158, FW Disp: 1.1, FW Main: 1.0) and configuration options. 'Language' is set to ENGLISH, and 'Relay test' has a 'TEST' button. 'Variable speed pump' is checked and activated. 'Type of VS pump' is set to TYPE A. 'Delay time' is configured as 10 min after a DOSE and 20 min after a START. At the bottom, there are navigation buttons: a back arrow, an information icon (i), a left arrow for the previous page, '1 / 5' for the current page, and a right arrow for the next page.

# Installation Test

**WARNING:** Any obstacles, bubbles or leaks in the connecting tube will prevent ASIN AQUA Eox Pro from correct operating. The clear plastic tube allows you to monitor flow of liquid to the injecting valves.

Before commencing the operation, test ASIN AQUA Eox Pro installation.

**Most problems result from incorrect installation.**

## Test

In the “Relay Test” menu, start pumps one by one and while they are running, check tightness of all the PE tube connections. Check the injecting valves for blockage and air bubbles in the PE tube.

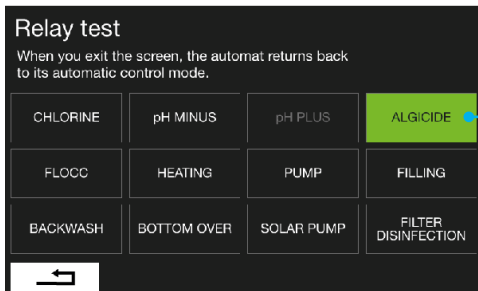
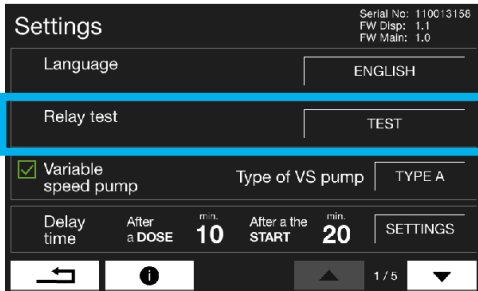

Press to **TURN ON (GREEN)** and press again to **TURN OFF**.

**DON'T FORGET!** After you complete the test, stop all accessories in the menu. Do not dose in this step!

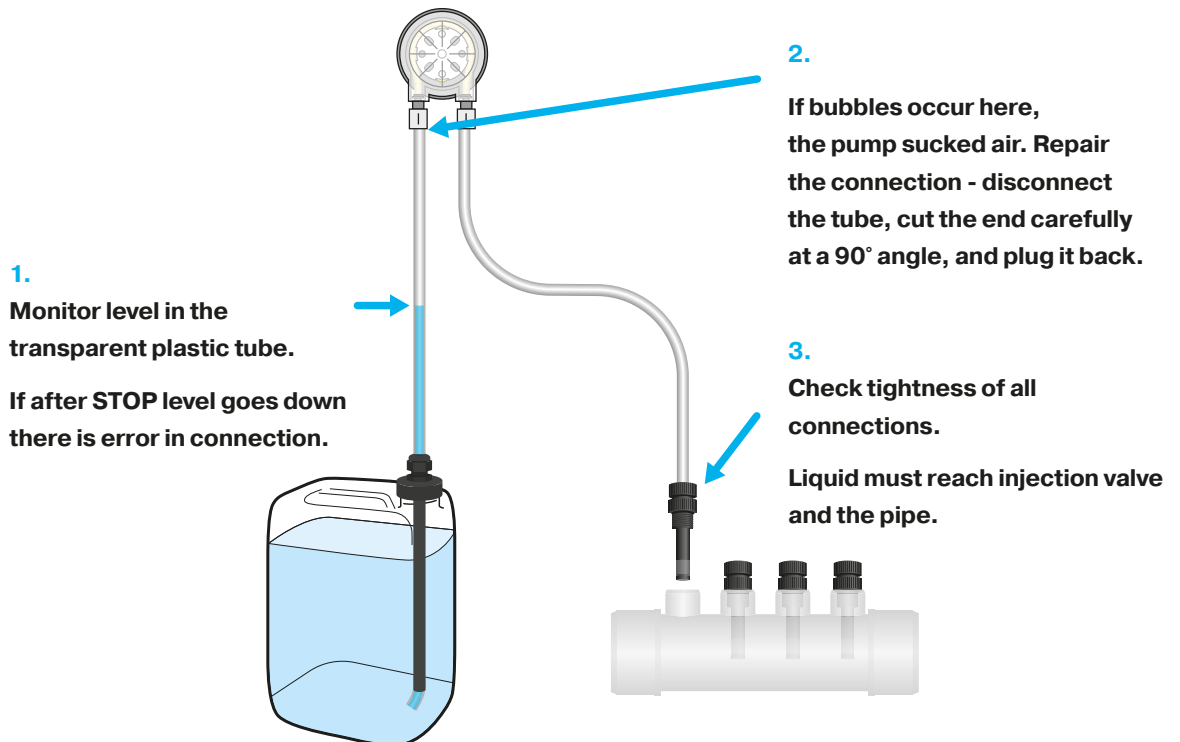

# Choosing the type of probe or the type of time dosing

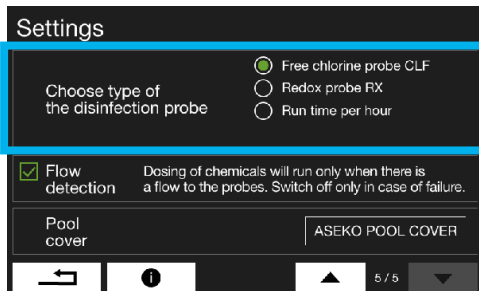

- 1. Redox – Salt** - Measures redox and uses saltwater electrolysis to produce chlorine and free oxidation radicals for effective disinfection of pool water. Additionally, dose algicide which is recommended for rainy conditions or ACO which is recommended for high temperature conditions.



- 2. Time dosing** In situations where a probe is not used or temporarily out of service, the system allows chlorine generation to be managed by time control. Set the desired operating duration - the number of minutes per hour for the electrolysis. This ensures continuous pool water disinfection in the temporary absence of disinfection probe.

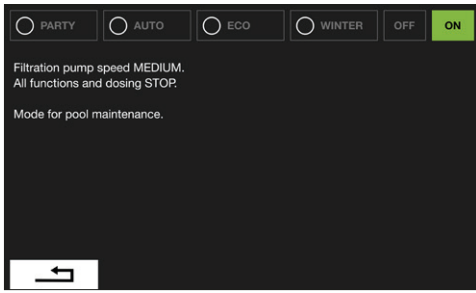

# Commissioning procedure and required value setting

## Commissioning procedure

The water in the pool must be clean without any additives especially free of cyanuric acid.

Ideally fill the pool with fresh water from the water main.

- Set the system to **MODE ON** - filtration NONSTOP 24 hours
- If you control with the CLF probe, set the disinfection to 0.0 mg/l.  
If you control with the REDOX probe, set the disinfection to 000 mV.

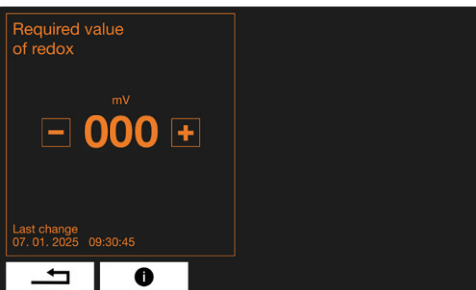
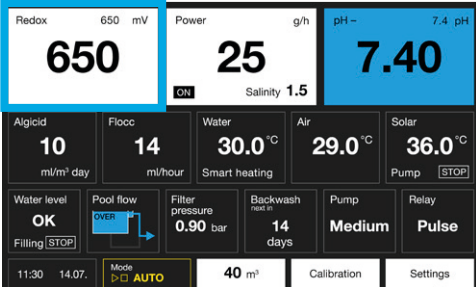

**CLOSE**



## Close the water supply to the probes

ASIN AQUA Eox Pro displays no flow to the probes.

## Perform superchlorination

Perform superchlorination of pool water with Super CHLOR (inorganic active chlorine without stabilizers).

Follow the instructions on the packaging (1 kg = 80 m<sup>3</sup>).



SuperCHLOR  
#13120

## Wait at least 1 hour. Optimally up to 24 hours

**Before opening the water supply** to the probes, the water must be **clean** and the **chlorine concentration** measured by the colorimeter or Pool Tester must be within the range **0.3 to 1.2 mg/l**.

If the **concentration is lower**, repeat superchlorination. If the **concentration is higher**, wait till the chlorine concentration in the water drop down.

**OPEN**



## Open the water supply to the probes

Warning No flow to probes turns off automatically.

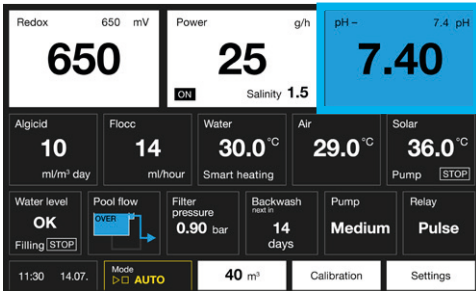

## pH Setting

With ASIN AQUA Eox Pro it is necessary to maintain pH 7.2-7.5 to keep longer lifespan of the electrode.

**Required pH value = refilled water pH value (in the range from 7.2 to 7.5)**

pH may change during operation but if it is in the range from 7.2 to 7.5 you do not have to change this setting.

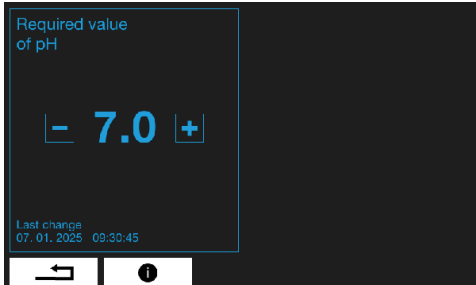

## ALGICIDE Setting

Flexible dosing of Algicide or ACO chlorine stabilizer to ensure ideal water quality in any environment.

Use Algicide in humid climates prone to algae growth, and ACO for uncovered pools exposed to sunlight and higher water temperatures.

A typical dosage of Algicide is 10 ml per m<sup>3</sup> per day, which can be temporarily increased if algae appear.

A typical dosage of ACO is 3 ml per m<sup>3</sup> per day.

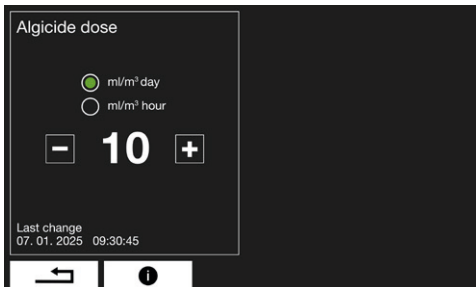
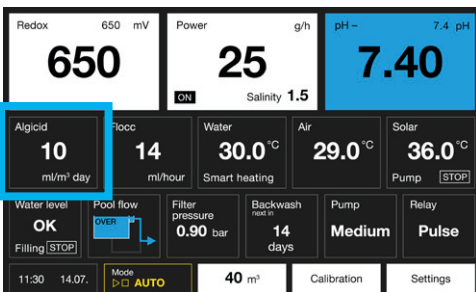

## FLOC+C Setting

The FLOC+C dose is calculated from the amount of circulating water, which flows through the filtration.

Based on your circulating pump power (in m<sup>3</sup> per hour), adjust the FLOC+C dose value. E.g. with the circulation pump with power of 10 m<sup>3</sup>/h set the FLOC+C dose to 10 ml/h. This value ranges from 10 to 40 ml per hour for most private pools.

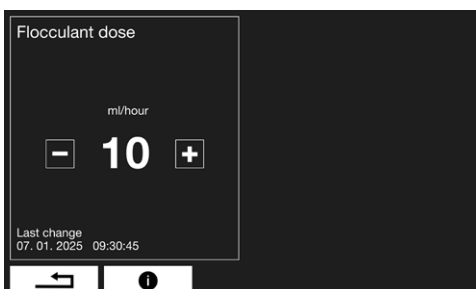
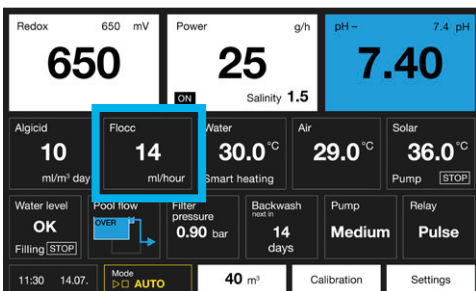

# If you have a Redox probe

For the REDOX probe to work properly, the following conditions must be met:

## pH of pool water

The ideal pH of pool water is 7.2

The pH value of the pool water must be stable.

If the pH value fluctuates, the Redox value in the pool water also changes.

## WARNING

Before proceeding to setting of the required values, keep the probe connected to the water for at least 1 hour, ideal 24 hours, to stabilize its measurement.

Chlorine content mg/l	Water temperature
0.3 to 0.5	24 to 26 °C
0.5 to 0.8	26 to 32 °C
0.8 to 1	Over 32 °C

## Required chlorine value

The table shows the recommended chlorine levels in pool water. The required chlorine content varies with the temperature of your pool water and should never be lower than 0.3 mg/l.

## Procedure for setting the desired Redox value

Set the desired **REDOX** value to 650 mV.

Use the tester to check that **the chlorine content in the pool water is between 0.5 and 1.2 mg/l.**

## Wait 24 hours for the probe to stabilize.

## Fine-tuning

Use a photometer to measure the chlorine value in a sample of pool water.

- If the chlorine value in the pool water is **IN DESIRED RANGE**, your ASIN AQUA is ready to maintain the desired chlorine concentration in the pool water.
- If the chlorine value in the pool water is **LOW**, increase the the desired REDOX mV value in the menu.
- If the chlorine value in the pool water is **HIGH**, decrease the the desired REDOX mV value in the menu.

**Every 10 mV corresponds to approximately 0.1 mg/l of chlorine in the pool water.**

## EXAMPLE:

The chlorine value in the pool water is 0.3 mg/l, the value shown on the display is 650 mV. If you want to have a chlorine value of 0.5 mg/l, you must increase the set redox value by 20 mV to 670 mV.

## NOTE:

The relationship between the redox potential and the chlorine content in the pool water cannot be determined using a precise table. The correct redox value must be determined by repeated photometric measurements.

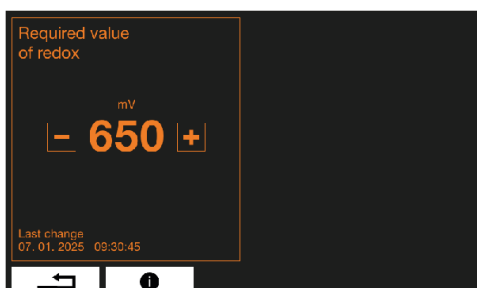

# Configuration

## Date and time

To ensure the correct function of timers, set the current date and time. Enter this menu by clicking on the date on the home screen or through the settings.

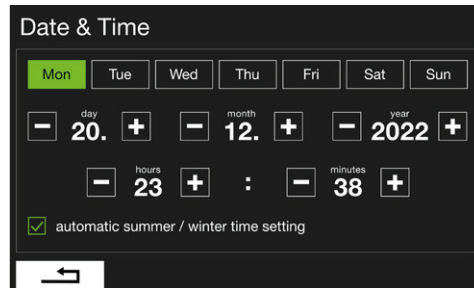
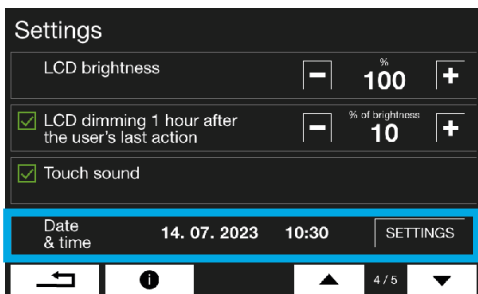
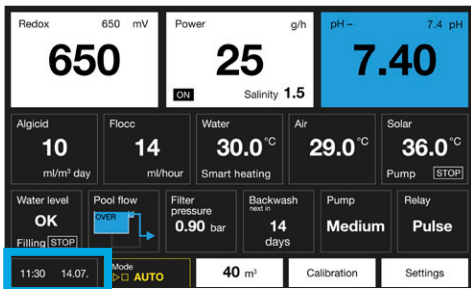

## Pool volume

### Pool volume

To ensure the correct function of ASIN AQUA Eox Pro, enter the correct volume of your pool. Enter this menu by clicking on the volume in the middle of the home screen.

Calculate your pool volume in m<sup>3</sup>:

Length (L) times width (W) times depth (D) is volume (V) - (L × W × D = V).

Enter the value using + and - buttons.

**WARNING:** The pool volume has effect on the dosing algorithm and maximum safe dose, enter the value correctly.

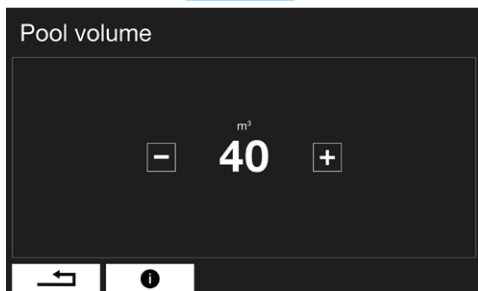
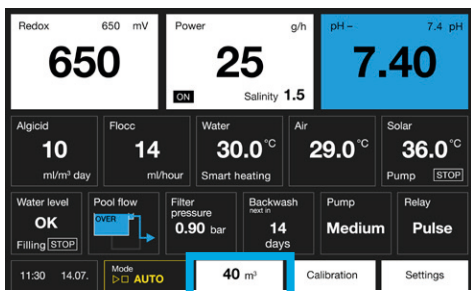

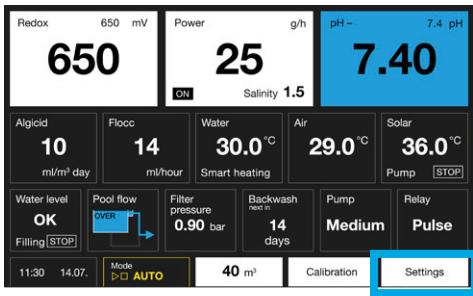

# Settings

## Language

Choose one of available languages.

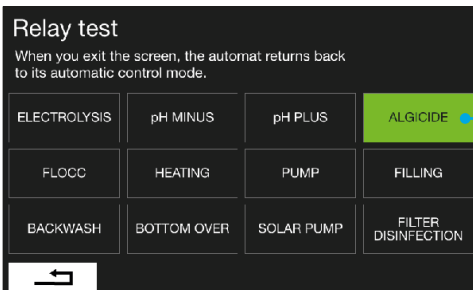
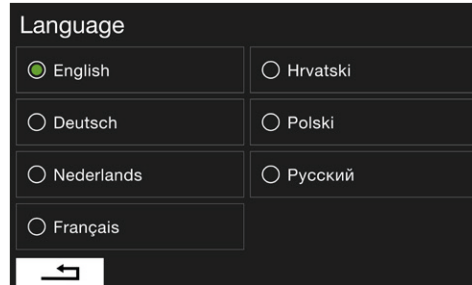
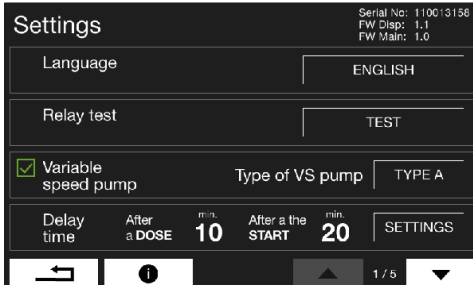

## Relay test

Test of the installation.

Press to **TURN ON (GREEN)** and press again to **TURN OFF**.

**DON'T FORGET! After you complete the test, stop all accessories in the menu. Do not dose in this step!**

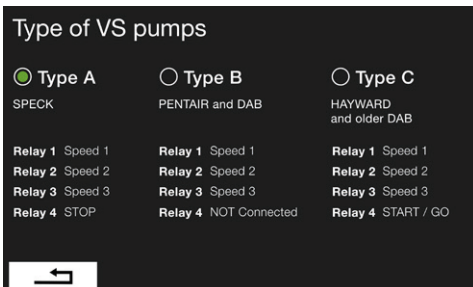

## Variable speed pump

Activate the function in the settings, and in the VS pump menu select the type of your variable speed pump.

Individual speeds are set directly on the pump according to the pump manufacturer's manual.

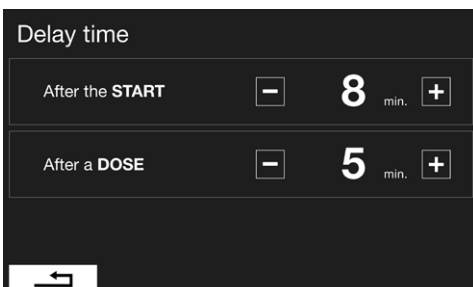

## Delay

**Delay time after start** of the filtration pump (upon timer switching ON) is time after start for which ASIN AQUA Eox Pro does not take any action and waits for stabilization of a signal from probes.

**Delay time after dose** is time for which ASIN AQUA Eox Pro does not dose and wait for the response of probes. The average response time is 4 to 10 min.

# Safety functions



## Maximum runtime without reaching the required value

If the required value is not reached within set number of days the electrolysis is stopped and warning is displayed.



## Maximum number of pH doses - without probe response

If the measured pH value does not change after the preset maximum number of doses (according to the settings), ASIN AQUA Eox Pro stops pH dosing and an error message appears on the display. Other ASIN AQUA Eox Pro functions are not limited.

The error message must be canceled manually.

In case of hard water, it is necessary to increase the maximum pH dose limit.

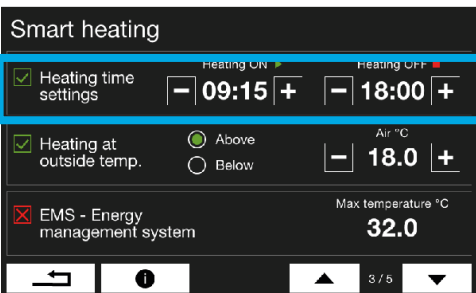

# Smart heating

## Heating time settings

This function allows to set a time for which the heating will be in operation.

The heat pump has higher efficiency during the day when outdoor temperature is higher.

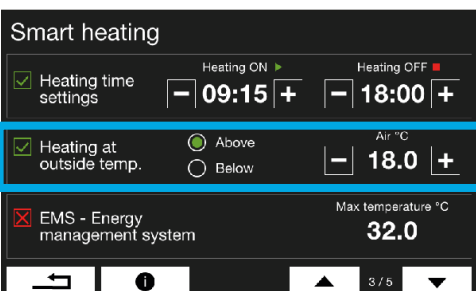

## Heating at outdoor temperature (above or below)

This feature allows to set the outdoor air temperature, at which or below which ASIN AQUA Eox Pro starts heating. To use this feature, an outdoor air thermometer must be installed.

### Above

This function is used to optimize the efficiency of heat pump, which is higher with higher air temperature.

### Below

When using the solar heating and the heat pump simultaneously, the below gives an option to automatically deactivate the heat pump and prioritize the solar heating which optimizes electric consumption.

- Check the BELOW option. Set the temperature between 30 and 40. When the temperature drops below the set value, the heat pump starts heating. When it rises above the set value, the heat pump stops, and heating is done only through the solar panel.

**NOTE:** Other heating functions can be set individually for each mode in the **MODE Settings** (ref. to the chapter MODE settings).

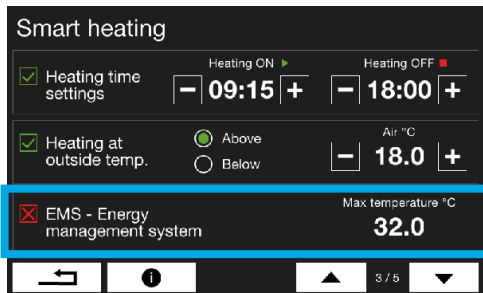

## EMS - Energy management system

This feature allows the efficient use of surplus energy generated by a home solar power plant to heat and filter pool water. Once activated, the device will monitor the incoming signal from the photovoltaic system and, upon detection, automatically start the pool's heating and filtration system.

**Outside the filtration period:** The circulation pump automatically starts at speed 1 and the heat pump is activated at the same time. The heat pump will remain in operation for at least 1 hour to prevent excessive switching and to prolong its life.

**During the filtration period:** The heat pump is activated automatically, regardless of whether the target temperature has already been reached.

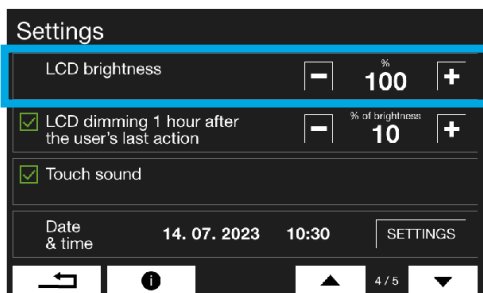

## LCD brightness

Set the LCD brightness.

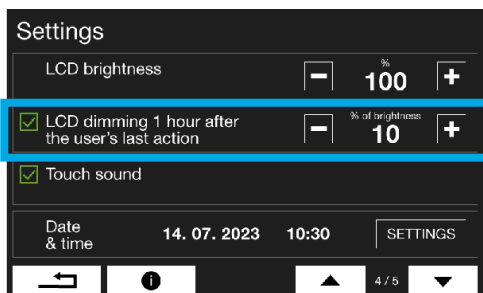

## LCD dimming

If enabled, after 60 minutes without interaction ASIN AQUA Eox Pro will reduce the brightness of the screen.



## Touch sound

If enabled, every touch on the touchscreen will make a sound.

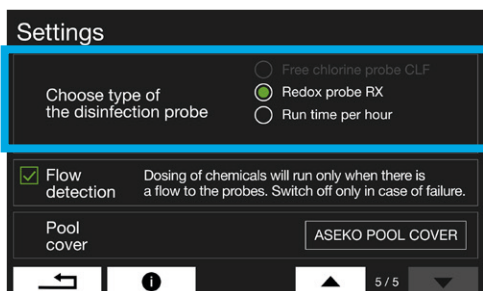

## Choose the type of the disinfection probe

Choose the probe which controls the dosing of disinfection.

Free chlorine probe - direct measurement of free chlorine concentration in ppm

Redox probe - oxidation-reduction potential (ORP) measurement in mV

Run time per hour- without probe, time based electrolysis

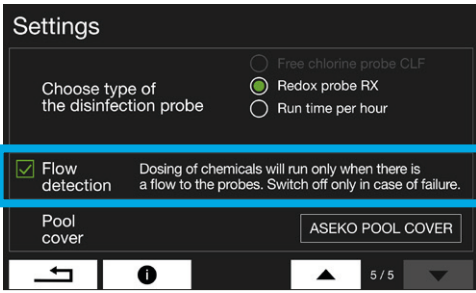

## Flow detection

The flow detector detects flow of measured water. Dosing of chemicals will take action only if the water flow to probes is detected to prevent dosing in standing water.

Wash the strainer on the measuring water filter on a regular basis.

**Warning:** Only switch off the flow detection in case of Flow detector failure.

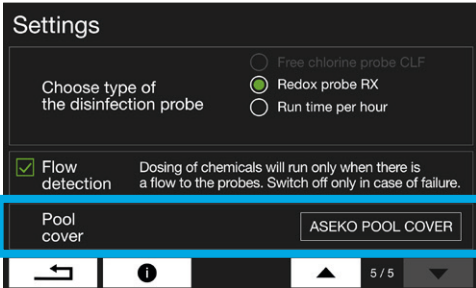

## Pool Cover position detection

If the pool cover is closed during the filtration time set by the timer, the VS pump will change the speed to the Speed 1 (LOW). When the cover is moving, ASIN AQUA automatically switches off the filtration pump.

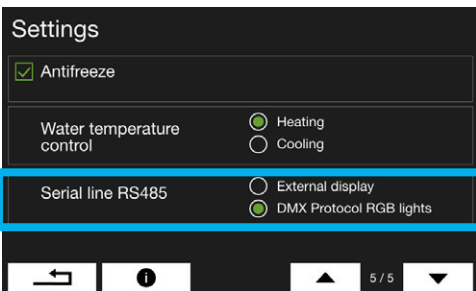
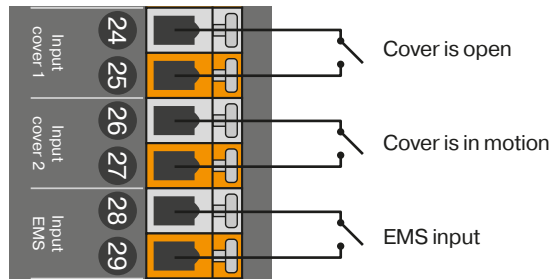

## DMX Protocol RGB Lights

In the menu of the device, select the Serial line RS485 to be in DMX Protocol RGB lights mode (more info in chapter RGB lights).

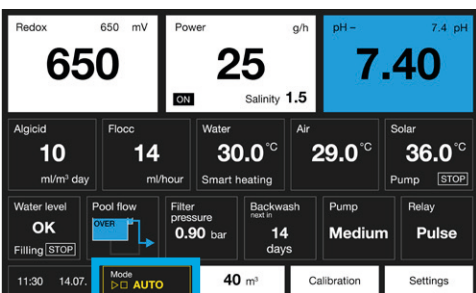
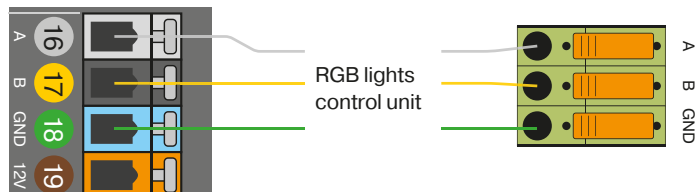

## Mode settings

Automate your pool with 6 adjustable modes.

**Party | Auto | Eco | Winter | Off | On**

Change modes through ASIN AQUA Eox Pro screen, external touchscreen, or smartphone app Pool REMOTE.

# Mode settings



## AUTO

The Auto mode for regular use of the pool. It uses all functions in a balanced way to achieve comfort and economic operation.

Set the filtration times: **morning** | **durin day** | **afternoon** | **night** and desired temperature. For each filtration time set the pool water flow, and the speed of the circulation pump.

### Temperature is superior to the filtration timer

Enabling this function will keep both the heating and the circulation pump operational until the desired water temperature is reached.

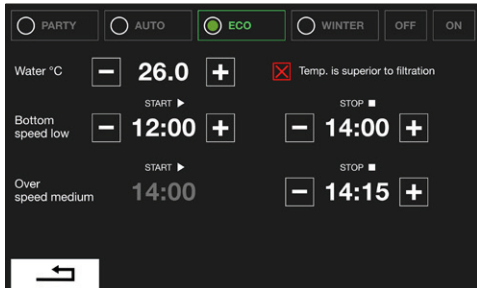

## ECO

The ECO mode is designed to operate the swimming pool in your absence or when you want to operate economically. Keeps the pool ready for a switch to normal operation.

Allows to set the desired temperature, the pool water flow, the speed of the circulation pump, and one filtration time.

There is always a 15-minute overflow filtration at the end of each period to prevent greening of the buffer tank.

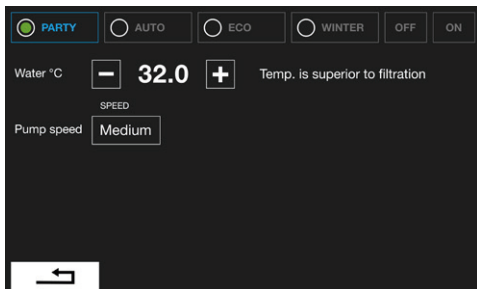

## PARTY

This mode switches ON the circulating pump on preset speed and heating to the required temperature.

**This mode has no time functions. To switch OFF the circulation pump and the heating change the mode.**

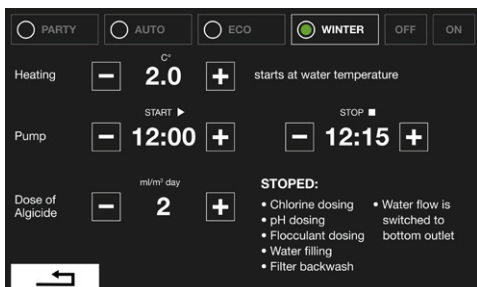

## WINTER

Activating this function set the device into the special Winter mode. This mode prevents the pool water from freezing and keeps the water clean with dosing of algicide. **In the Winter mode following function are deactivated:**

chlorine dosing, pH dosing, flocculant dosing, water filling, filter backwash.

**Water flow is set to the bottom drain.**

Every day the filtration pump runs in preset filtration timer.

Outside of the filtration timer the filtration pump remains OFF but is automatically activated for the period of 15 minutes when the outdoor temperature drops below 0 °C.

- If, after this period, the water temperature is under the required value (0 - 6 °C), the filtration pump stays ON, and the heating is activated until the water temperature exceeds 2 °C.
- If, after this period, the water temperature is higher than the required value (0 - 6 °C), the circulation pump is turned OFF.

If the outdoor temperature stays below 0 °C this cycle is repeated every 6 hours.

When using the Winter mode without the **outdoor air thermometer**, the system acts as it always detects 0 °C outdoor temperature.

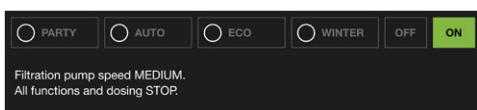

## ON

The filtration runs NONSTOP. The heating is OFF.

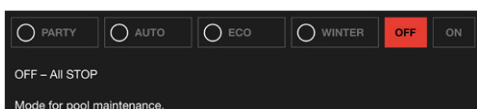

## OFF

Everything is OFF.

# Functions

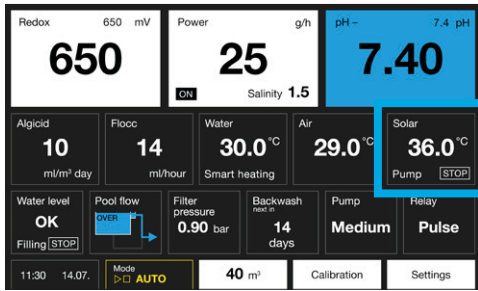

## Pump timer

The field displays the current filtration timer interval and the current speed of the filtration pump.

Press the field to go to the settings of the current mode.

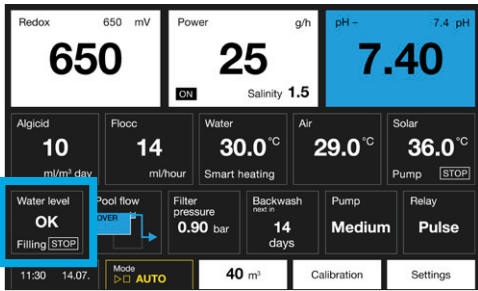

## Hydrostatic pressure water level sensor - level monitoring and automatic refilling

The water level is monitored using a pressure-type level sensor, which is easy installed by inserting the probe into the buffer tank or the blind nozzle of skimmer pools. Water level is measured in centimeters. ASIN AQUA monitors four different levels, which can be set in centimeters in the water level meter menu.

### Setting:

#### High level ALARM - too much water in buffer tank

After this level is reached, following actions may start:

1. If the automatic filter backwash is enabled, one backwash cycle starts and drains the waste water.
2. If the automatic filter backwash is not enabled, the relay switches on (filter backwash) for the period of time until level is OK. The second circulating pump or automatic drain valve can be connected to this relay.

#### Refilling OFF - required level

Refilling stops

#### Refilling ON - level at which refilling starts

Refilling starts when the water level stays for at least 10 seconds below this value (in order to prevent oscillating).

#### Low level ALARM

Circulation (filtration) pump shuts off.

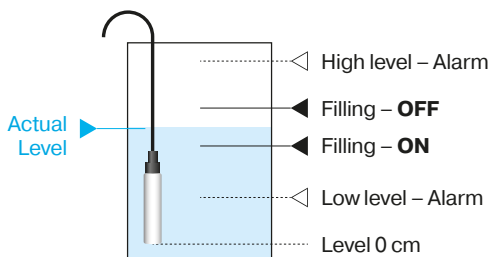
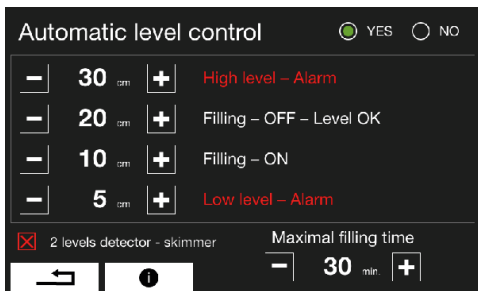

## Float switch

With the skimmer water level detector #13366 (float switch), the water level is monitored in two levels.

**Filling - OFF** required level reached. Refilling stops.

**Filling - ON** level at which refilling starts. Refilling starts if the water level stays for 10 seconds below this value to prevent oscillating.

## Maximum Refilling Time

Maximum time to reach the required water level. If the water level is not reached within the preset maximum refilling time an error message appears.

Set the maximum filling time to 0 to disable the maximal filling time function.

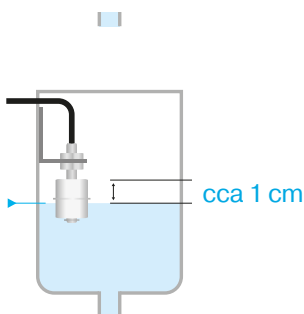

# Functions

## Switch Overflow/Bottom drain – Besgo 3w

The box shows the current direction of water flow to the filtration.

Enable this function to change the direction of the water flow.

This change will be valid until the next timer event.

During filter backwash, water flows through the BOTTOM DRAIN.

An alarm WATER LEVEL TOO HIGH switches the water flow to the OVERFLOW until the alarm expires.

The pool cover has no effect on the BOTTOM/OVERFLOW switching.

**The three-way BESGO should be connected in a way that when the solenoid valve is not powered, water flows through the BOTTOM.**

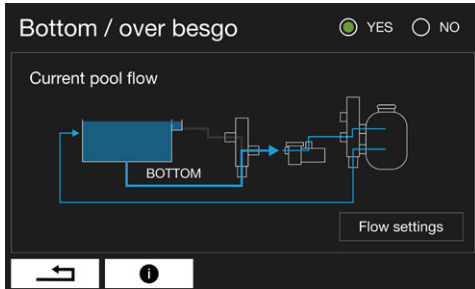
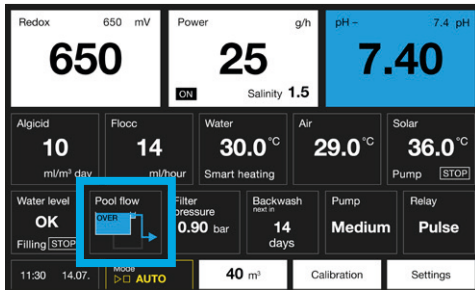

# Functions

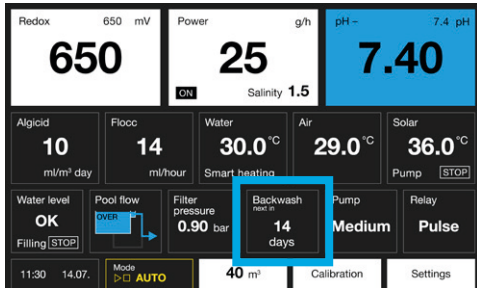

## Automatic filter backwash

The ASIN AQUA technology is in particular based on the high efficiency of filtering and removing even the finest impurities, it is necessary to **wash the filter on a regular basis**. The automatic filter backwashing function ensures the filter washing on a regular basis in the preselected intervals.

**To enable this function, it is necessary to use the automatic 5-way BESGO valve.** The ASIN AQUA controls the BESGO valve with relay output.

When the relay switches ON, the BESGO valve switches to the required position with the pressure of water or air and performs the filter backwash. See the BESGO manual.

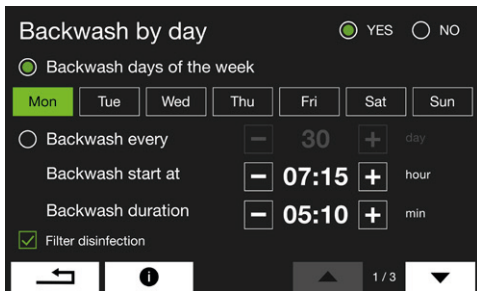

## Backwash by pressure

The ASIN AQUA Eox Pro offers an additional feature for automatic backwashing based on the pressure in the filter. If the pressure exceeds the preset value, the device will automatically initiate a backwashing cycle. In practice, this means the device performs backwashing according to the settings on the previous screen and executes an additional backwashing cycle if the pressure in the filter increases beyond the set threshold. To enable this feature, a pressure gauge must be installed on the filter.

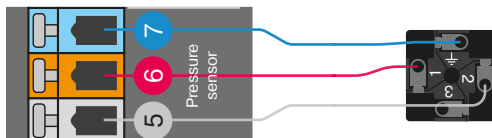
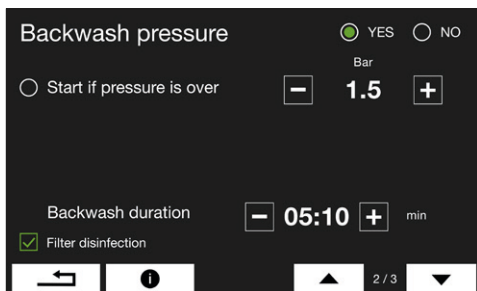

## Filter disinfection

An optional PP60 pump can be connected to the filter disinfection output. This pump activates automatically during the backwash cycle to ensure thorough sanitization of the filter using liquid chlorine. The filter is completely disinfected, and no additional chlorine enters the pool, as the chlorinated water is discharged to waste during backwash.

# Functions

## Solar

Menu shows the solar settings.

Activate this function and set the required temperature for the solar panels. Once the required temperature of the solar panels is reached, the solar relay will activate. The solar relay can control the Besgo 4-way or the solar panel circulation pump.

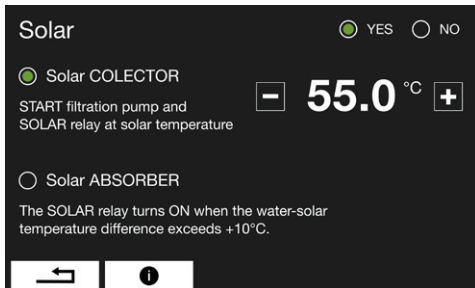
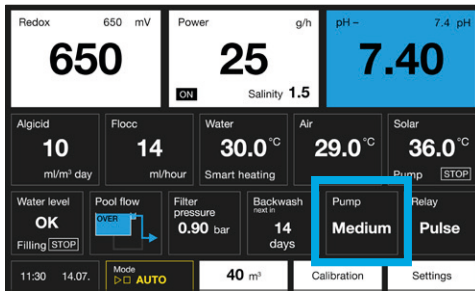

## Relays

ASIN AQUA Eox Pro has one integrated programmable relay to control one extra accessory. It is also possible to connect optional **RL module** (relay module) to connect 4 extra relays.

Relays have functions: Week timer, Countdown and ON / OFF. Relays can be set and controlled also via the Pool REMOTE app.

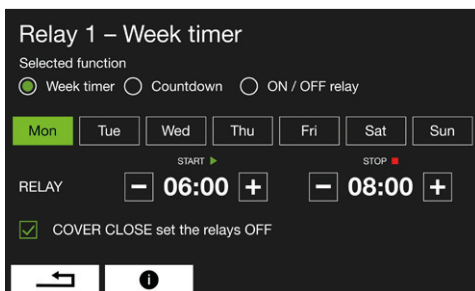
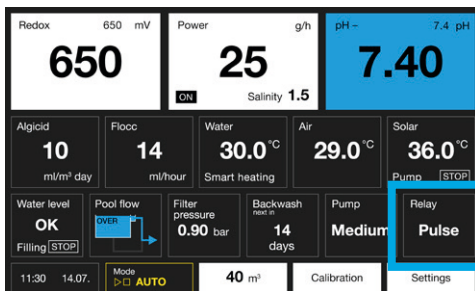

**Week timer** - Set the specific days and times for relay activation.

**Countdown** - Set the time for which the relay is active. Turn on the relay manually or with the Pool REMOTE app. The relay switches OFF after the time countdown is complete.

**ON / OFF relay** - Control the relay manually or with the Pool REMOTE app.

**Pulse** - A pulse relay sends a short electrical pulse to trigger another device or circuit.

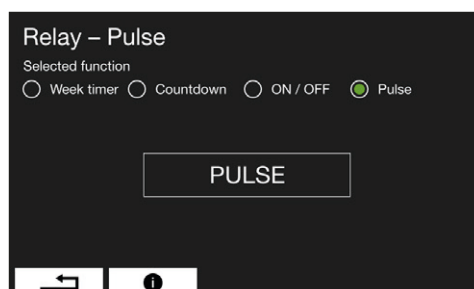
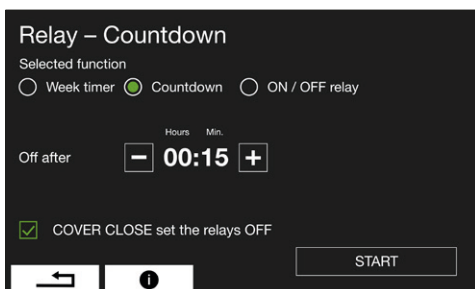
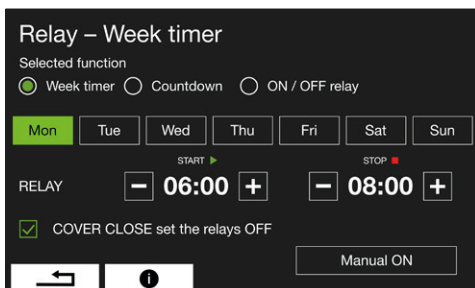

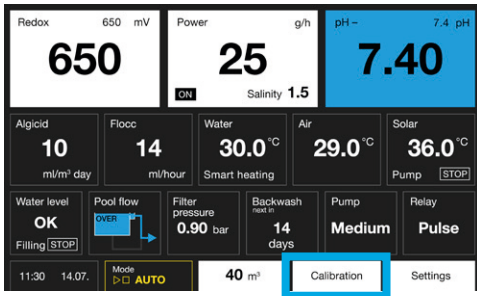

# In operation measurement and calibration

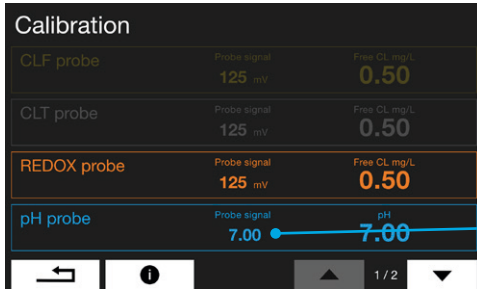

## pH probe calibration

When pH is being measured in operation, there may be a difference between the value measured by ASIN AQUA and the actual pH value in water.

Proceed to the calibration.

### pH probe calibration menu

#### Non-calibrated value

The pH probe calibration menu always displays the original non-calibrated value. Calibration of the pH probe is not possible when the new value differs by more than 1 from the non-calibrated value. If the difference from the non-calibrated value exceeds 1, the probe should be sent for inspection or replaced with a new one.

**Calibration is not possible when the new value differs by more than 1 from the non-calibrated value.**

**The pH probe can only be calibrated in the pH range of 6.2 to 7.8.**

**The pH probe cannot be calibrated when the LOW or HIGH warning is displayed.**

### pH probe calibration process

Calibration can be done in two ways:

#### 1. With a buffer

- **Close the water supply to the probes.**
- Remove the probe from ASIN AQUA Eox Pro :  
rinse the probe with clean water and wipe it.
- The probe must remain connected to the device via the cable. Dip the probe in the calibration buffer and after the value displayed on ASIN AQUA is stable, enter the buffer value into the pH Probe Calibration menu.

#### 2. With a colorimeter or Pool Tester

- **The water supply to the probes must be open**
- Measure the pH value directly in pool water using a colorimeter or Pool Tester.
- Then enter this value into the pH Probe Calibration menu. Calibration can be performed in the range of 6.4-7.8.

pH 7.00 Buffer #12065



Digital Photometer  
Aseko  
#13449



# In operation measurement and calibration

Calibration		
CLF probe	Probe signal 125 mV	Free CL (mg/L) 0.50
CLT probe	Probe signal 125 mV	Free CL (mg/L) 0.50
<b>REDOX probe</b>	Probe signal <b>125 mV</b>	Free CL (mg/L) <b>0.50</b>
pH probe	Probe signal 7.00	pH <b>7.00</b>

Redox Buffer 650mV  
#12091



## Redox probe calibration

### Use a buffer

- **Close the water supply to the probes.**
- Remove the probe from ASIN AQUA Eox Pro: rinse the probe with clean water and wipe it with a paper towel.
- The probe must remain connected to the device via the cable during the calibration. Dip the probe in the calibration buffer and after the value displayed on ASIN AQUA Eox Pro is stable, enter the buffer value into the Redox probe calibration menu.

**RECOMMENDATION:** Perform the calibration using the 650 mV buffer. If the non-calibrated value differs by 50 mV from the buffer, it indicates that the probe is faulty.

## Water thermometer calibration

If the temperature of water in the pool is different from the temperature shown on ASIN AQUA Eox Pro, calibrate the water thermometer in the water thermometer calibration menu.

Calibration		
Water thermometer	Temp. °C 53.0	°C <b>53.0</b>
Air thermometer	Temp. °C 11.5	°C <b>11.5</b>
Solar thermometer	Temp. °C 1.8	°C <b>1.8</b>

## Outdoor air thermometer calibration

If the temperature of air is different from the temperature shown on ASIN AQUA Eox Pro, calibrate the air thermometer in the air thermometer calibration menu.

## Solar thermometer calibration

If the temperature of solar is different from the temperature shown on ASIN AQUA, calibrate the solar thermometer in the solar thermometer calibration menu.

Calibration		
Filter flow meter	Signal m <sup>3</sup> /h 11.5	Flow m <sup>3</sup> /h <b>11.5</b>
Salinity	Signal kg/m <sup>3</sup> 1.8	kg/m <sup>3</sup> <b>1.8</b>

## Salinity calibration

If salt concentration in the water is different from concentration shown by ASIN AQUA Eox Pro, calibrate the salinity in the Salinity calibration menu.

**Warning:** Salinity calibration is not possible if the water thermometer is not connected.

## Stabilizer in water

**The water in the pool must be clean without any additives.  
Ideally fill the pool with fresh water from the water main.**

## Cyanuric Acid

The value of Cyanuric acid must be **0 ppm**. Cyanuric acid greatly diminishes the effectiveness of chlorine, making it difficult to accurately measure and control its concentration.



## Lifespan of the electrolytic cell

Lifetime of the electrolytic cell is 8000 running hours. The electrodes in the electrolytic cell are made of titanium with a ruthenium and iridium layer. During electrolysis this layer gets consumed. Durability of the electrodes is reduced by the following parameters: Low salt content, Water temperature below 10 ° C, Low water flow, Too hard water, pH below 7.5, Addition of metals containing preparations.

### **Never use stabilizers with cyanuric acid in ASIN AQUA devices**

#### **The value of Cyanuric acid must be 0 ppm!**

Cyanuric acid forms a chlorine-cyanurate complex, which rapidly decreases the disinfecting power of chlorine and makes it impossible to measure with a free chlorine probe. Be aware that some chlorine tablets contain cyanuric acid. Ensure there is no cyanuric acid in your pool.

# Maintenance

Replacement hose for the pump PP 60  
#12073

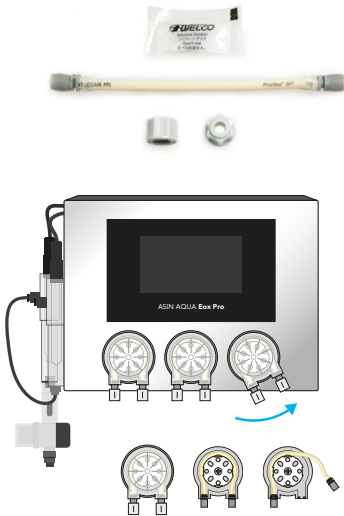

To ensure the optimum efficiency, perform visual checks and maintenance of ASIN AQUA Eox Pro on a regular basis.

## Pump tube replacement

To prevent the pump from failing, it is recommended to replace the tube #12073 every 24 months.

**In doing so, proceed as follows:**

- Switch off ASIN AQUA Eox Pro.
- Turn the pump cover cassette counterclockwise and take it out of ASIN AQUA Eox Pro.
- Release both tube ends and take it out of the cassette.
- Lubricate the new tube with the supplied special grease.
- Insert the lubricated hose into the cassette.
- Place the cover cassette back on ASIN AQUA Eox Pro and turn it clockwise to lock it.
- Use new nuts, which are part of the replacement tube set, for connection of the PE tube.

Injection valve #12005



Replacement rubber band for injection  
valve #13087



## Injection valve maintenance

On a regular basis, check throughput of the injection valves, rubber band integrity, remove scale.

In case of private pools, replace injection valve rubber bands #13087 every 2 years. In case of public pools, replace #12005 every year.

Flow detector #12106



## Flow detector with filter

Rinse the filter of the flow detector regularly.

Fuse T 1 A #13079  
or Fuse T 8 A #13097



## Fuse Replacement

### T 8 A

Fuse protecting the inner electronics. In case of its burnout, check the inner electronics.

### T 1 A fuse

Fuse protecting external sensors. In case of burnout of this fuse, check the level sensor, flow detector, and external display.

pH - Buffer 7,00  
#12065



## pH probe test

The pH probe can be declared functional if it meets the following criteria:

- it is not visibly mechanically damaged
- If the difference between the non-calibrated reading and the reference value exceeds  $\pm 1.0$  pH, the probe is considered faulty.

Example: the pH of the water is 7.2 and the probe measures 7.9 the tolerance is 0.7, which is less than the permitted 1.0 the probe is OK

- the probe reacts to positive and negative changes in the pH of the water or buffer

**Example:** if we insert a probe with a clean tip into a buffer with a pH of 7.0, the probe must respond to 90% of the range within 1 minute.

Redox Buffer 650mV  
#12091



## REDOX probe test

The Redox probe can be declared functional if it meets the following criteria:

- it is not visibly mechanically damaged
- The redox probe ages naturally, so its sensitivity decreases, but it should never fall below a certain limit. The permissible deviation is 50 mV; when tested with a buffer of 650 mV, it should not show less than a minimum of 600 mV
- the probe reacts to both positive and negative changes in the free chlorine content of the water

**No manufacturer of pH and redox probes provides a warranty. However, ASEKO has decided to provide its customers with a two-year warranty on probes purchased together with the device, during which you are entitled to free repair of probes if they show deviations greater than those specified above.**

## CLF probe test

At a free chlorine concentration of 0.8 mg/l, the normal signal output from the free chlorine probe should be approximately 80 mV. If the signal at this concentration is lower than 30 mV, it suggests that there may be an issue either with the water quality or with the probe itself. In such cases, please consult the CLF probe manual and follow the recommended troubleshooting procedures to verify the probe's performance.

Test using clean water that has been left to stand for 24 hours, ensuring it is free of chlorine. In this scenario, the signal should not be above 10 mV. If the signal exceeds this value, the probe may be faulty.

## Electrolysis cell cleaning

Scale deposits from hard water may reduce electrolysis cell performance.

The cell is equipped with a self-cleaning function based on polarity switching.

Increasing the switching frequency can help limit limescale buildup but reduces electrode service life.

If self-cleaning is not enough and deposits persist, remove the cell and clean it in a cleaning bath for approximately 10 minutes.



# Winterizing - storage during winter

If you want to operate ASIN AQUA Eox Pro in Winter mode, go to the chapter Mode settings - Winter mode. If you do not want to operate the device in Winter mode, it is necessary to winterize the device and all its components (store them when not in use).

## Winterization of the unit and its accessories

If you do not want to have the ASIN AQUA Eox Pro device in operation in winter, the device and all accessories must be dismantled, winterized and moved to a suitable location. To disassemble and winterize the ASIN AQUA Eox Pro, follow the instructions below.

### Storing of pool chemicals, connecting PE tube and dosing pumps

- If the chemicals are left in a place where the temperature does not drop below 0°C, turn OFF the ASIN AQUA Eox Pro. Disconnect the dosing pumps from the ASIN AQUA Eox Pro and remove the inner tube from the pump. Leave the tube connected to the connecting PE tube. Put the pump cartridges without the inner tubes back onto the ASIN AQUA Eox Pro. Store the chemical barrels and connecting PE tube in a place where the temperature is between +0 - +40 °C.
- If chemicals remain in a location where the temperature drops below 0°C, SWITCH OFF ASIN AQUA Eox Pro. Remove the connecting PE tubes from the chemical barrels and place them in a container with water. Turn on ASIN AQUA Eox Pro. Go to the RELAY TEST menu and press Chlor/Oxypure, pH, Algicide and Floc. When the connecting PE tube is completely filled with water, turn OFF the relay test. Remove the water container and perform the RELAY TEST again to completely fill the connecting PE tube with air. When the connecting PE tube is completely filled with air, stop the relay test and turn OFF the ASIN AQUA Eox Pro. Disconnect the connecting PE tubes from the dosing pumps and from the injection valves. Store the chemical barrels in a place where the temperature is between +0 - +40 °C.

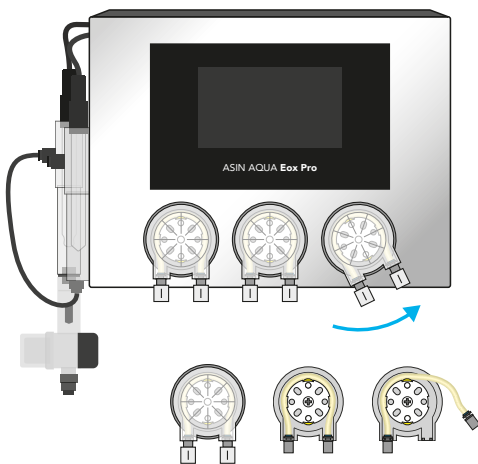

### Disconnect of the ASIN AQUA Eox Pro and its accessories

1. Disconnect the ASIN AQUA Eox Pro mains cable from the 230 V / 50 Hz socket.
2. Disconnect the filter unit's mains cable from the ASIN AQUA Eox Pro and store the filtration pump according to manufacturers manual.
3. Disconnect all accessories from the ASIN AQUA Eox Pro motherboard and store them according to manufacturers manual.

pH/Rx probe storage sump  
#12154



Storage liquid for pH and REDOX probe  
#12082



## Winterizing of probes

### Winterizing of pH and Redox probe

Remove the probe from the housing, dry it with a paper towel and place it in a storage sump filled with a special storage liquid. See probes manual at the website [manuals.asekopool.com](http://manuals.asekopool.com).

### Winterizing of CLF probe

Remove the probe from the housing, unscrew the membrane and empty the electrolyte from it. Do not put the membrane back on the probe and store them separately in a dust-free place where the temperature is between +5 - +40 °C and the humidity does not exceed 70% throughout the winter. See probes manual at the website [manuals.asekopool.com](http://manuals.asekopool.com).

## Storing of the unit

Move the ASIN AQUA Eox Pro unit in a place where the temperature is between +5 - +40 °C and the humidity does not exceed 70%.

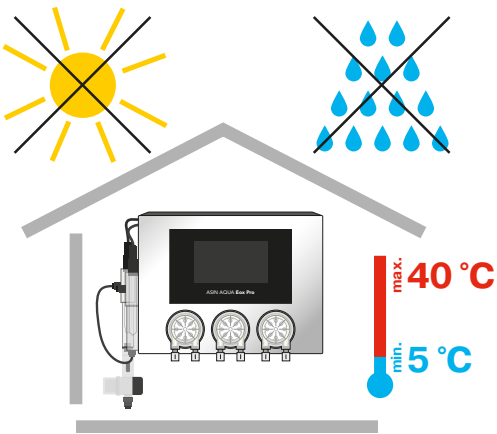

# Internet connection

The LAN connector is to be connected to the domestic router. Data are sent in the intervals of 10 seconds to the address **aseko.cloud**, the route must not be blocked by the firewall.

If you are not able to setup the connection by your own ask your IT specialist for help.

## Possible connection methods

### Home network

Connect the ASIN AQUA Eox Pro to your router via LAN cable.

### Mobile network

In case you have no direct internet access you can use the data transmission over the mobile network. Connect the ASIN AQUA Eox Pro to your mobile network router via LAN cable.

### Wifi connection

If you install the ASIN AQUA Eox Pro in place where is no access to your private network by wired connection but your Wifi has enough signal, you can connect the ASIN AQUA Eox Pro to your Wifi by use of Wifi extender.

### Powerline via 230V/DC

If you have no wired access to your LAN network but your ASIN AQUA Eox Pro is in the at the same electric network you can connect the LAN network via 230 V power line socket adapter.

#### **If you have connection problems:**

If you experience connection problems, you can find a step-by-step guide called AA-Internet\_Connections-Man in the Internet connection folder at [manuals.asekopool.com](http://manuals.asekopool.com).

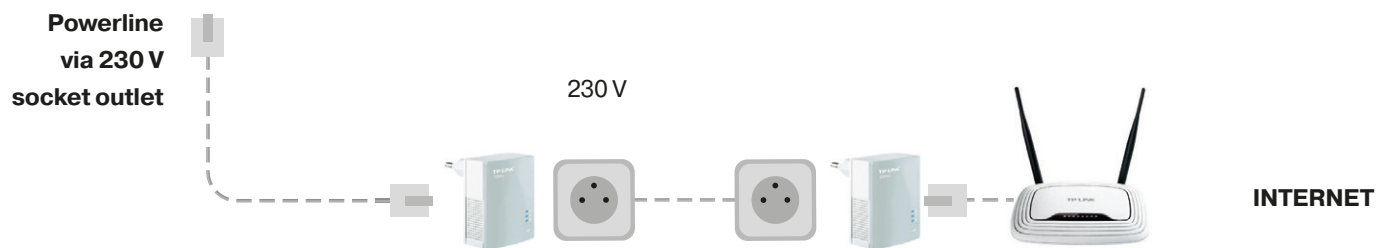
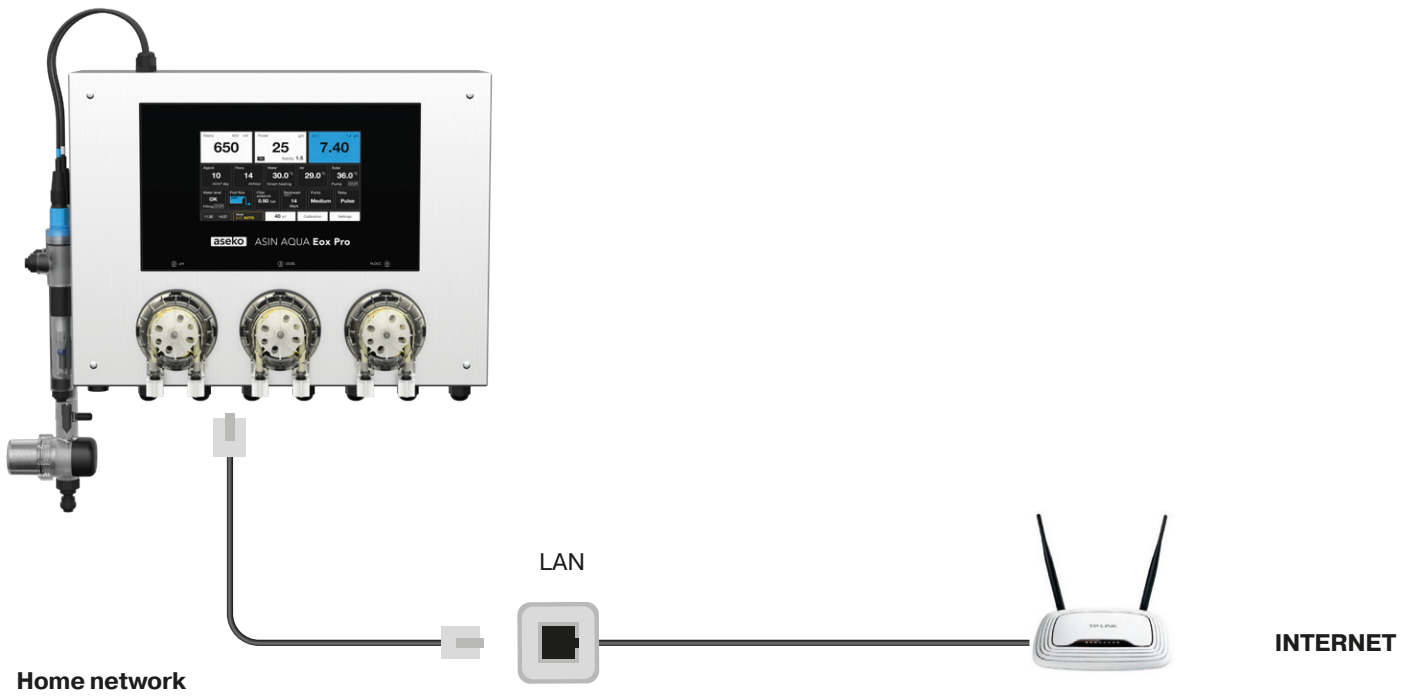

# Aseko Live app



- Clear monitoring of water quality, temperature, and equipment status
- Chemical consumption tracking
- automatic alerts for low chemical levels, exceeded measurement limits (chlorine, pH), and device errors or malfunctions
- Remote monitoring – access your pool data anytime, anywhere
- Aseko Live app available for iOS and Android

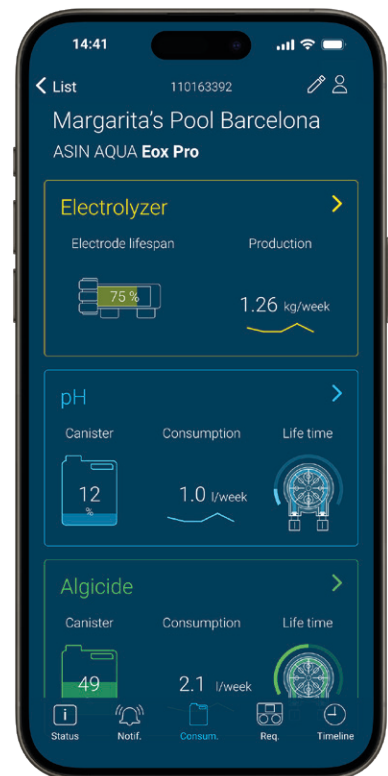
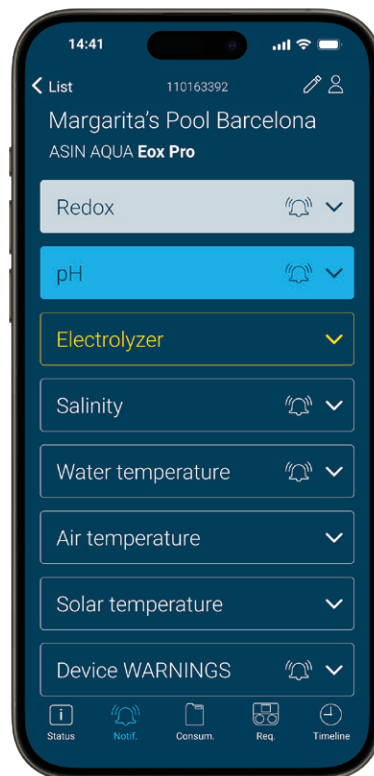

Aseko Live  
for iOS



Aseko Live  
for Android



# <https://aseko.cloud>

- Web application with a clear, intuitive interface for monitoring pool water quality
- monitoring of water quality, temperature, and equipment status,
- chemical consumption tracking,
- automatic alerts for low chemical levels, exceeded measurement limits (chlorine, pH), and device errors or malfunctions
- Detailed, professional charts visualizing current conditions and 30-day history. Ideal for technicians and public pool operators – enables trend analysis, correlation insights, and efficient remote diagnostics
- Data export for hygiene and regulatory documentation in professional pool operations
- Easy integration into superior control systems and smart homes via an open API

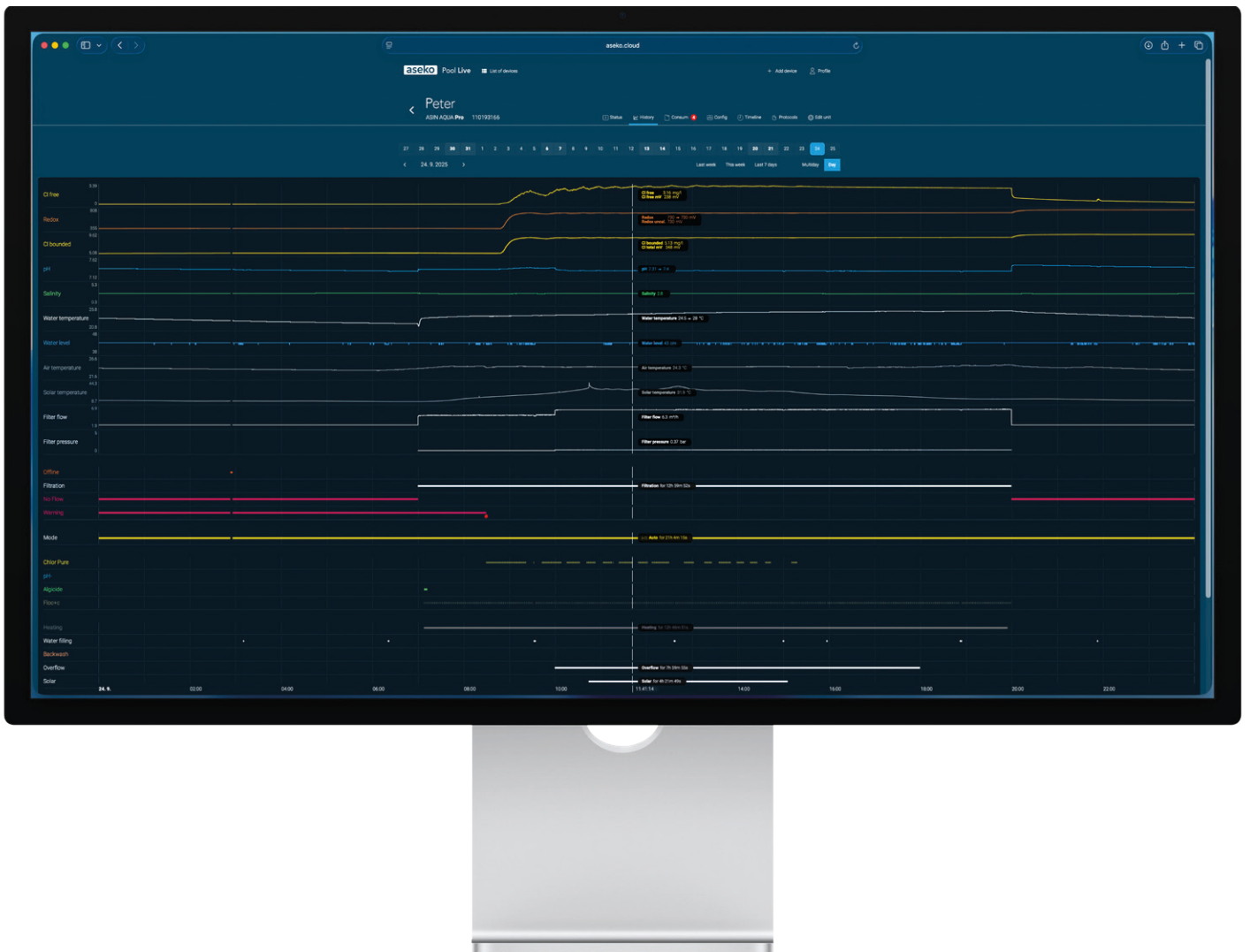

# Aseko Remote App



- Aseko Remote app for advanced remote control of pool technology
- Switching between intuitive preset modes (Auto, Eco, Party, On and OFF)
- Adjust filtration timer settings directly from your smartphone
- Control water flow direction – choose between overflow or bottom drain
- Set pump speed and optimize performance according to pool use
- Enables remote control of up to five connected components (e.g., lights, cover, water features)
- Supports remote filter backwash start for easy maintenance
- Invite process for easy sharing of remote control
- Aseko Remote app available for iOS and Android

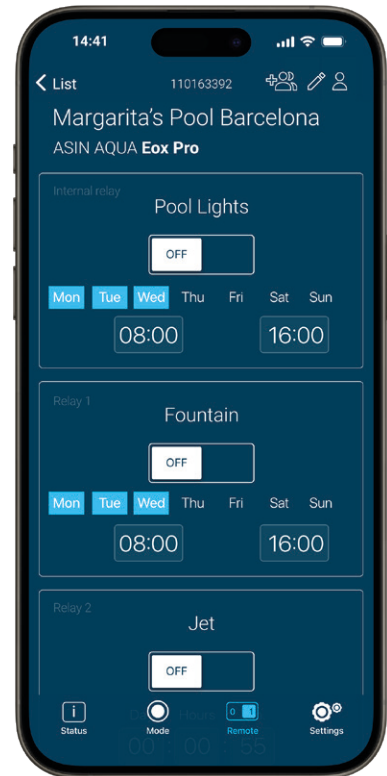
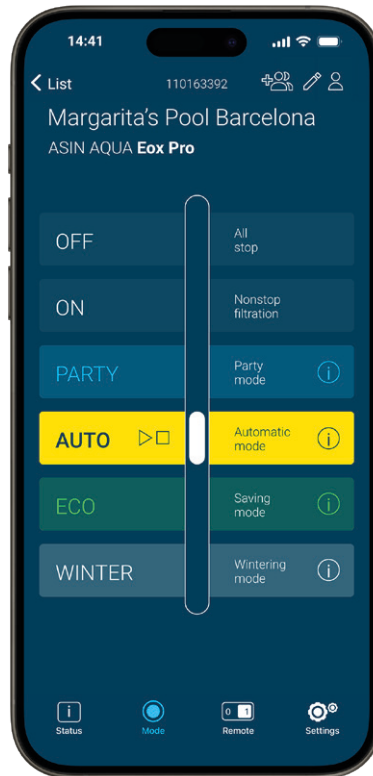

Aseko Remote  
for iOS



Aseko Remote  
for Android



## Create your account

Create your account in app or use your existing Aseko Live account.

### Enter serial number

Enter the serial number of your ASIN AQUA Home Pro to add the unit under your account.

## Overview

The screen provides all the important information about the current status of your pool and the connected components controlled by ASIN AQUA Home Pro.

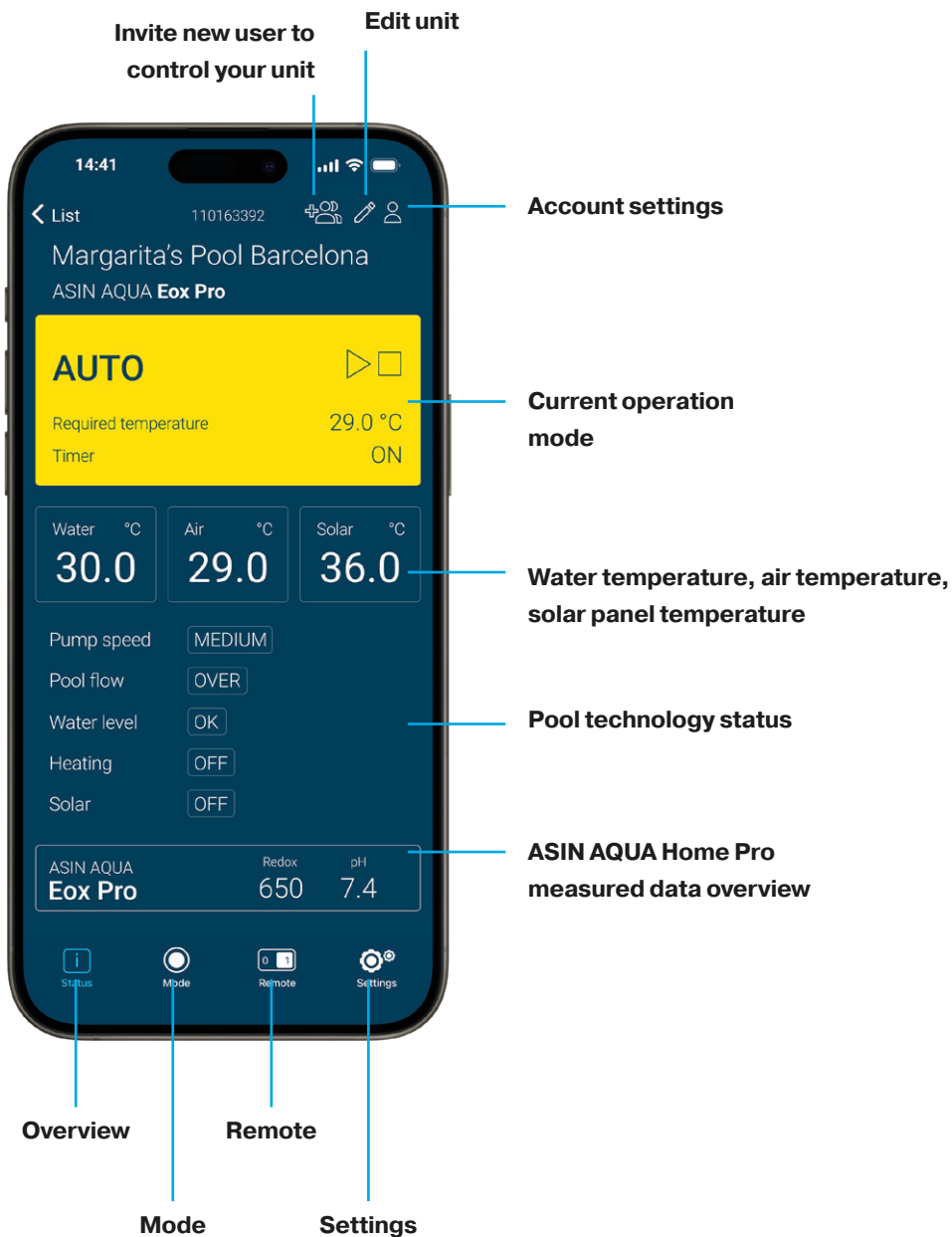

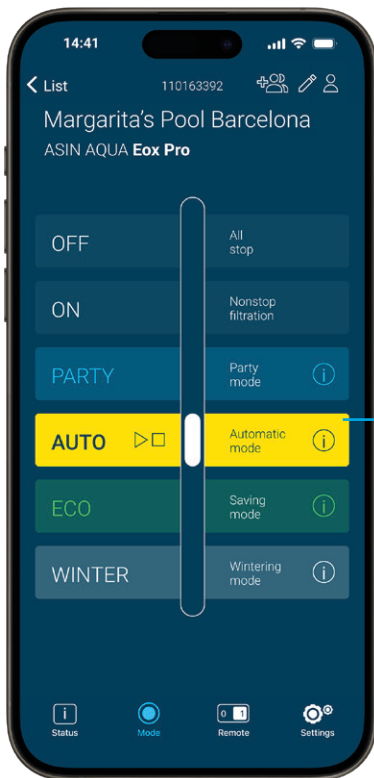

## Mode selection

The screen serves to switch between operation modes of your pool controlled via ASIN Pool.

The slider serves to control your pool operation modes.

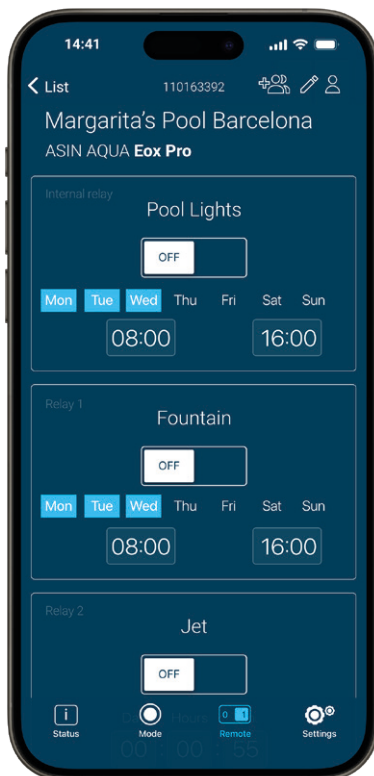

## Remote control

Customize the functionality of each relay in the settings tab. Control relays manually by turning them ON or OFF, send pulses, or configuring them as week timers to automatically operate your pool equipment at specific times of the day.

**Warning: The pulse relay feature can be used to remotely open a close a pool cover. Note that remote control of pool covers is prohibited in certain countries due to safety regulations. It is your responsibility to ensure compliance with the laws and safety standards of your country regarding the use of remotely controlled pool covers. Always prioritize safety and follow all local guidelines and regulations.**

## Relay extension module

Number of relays can be extended from 1 to 5 using a RL module #13065.

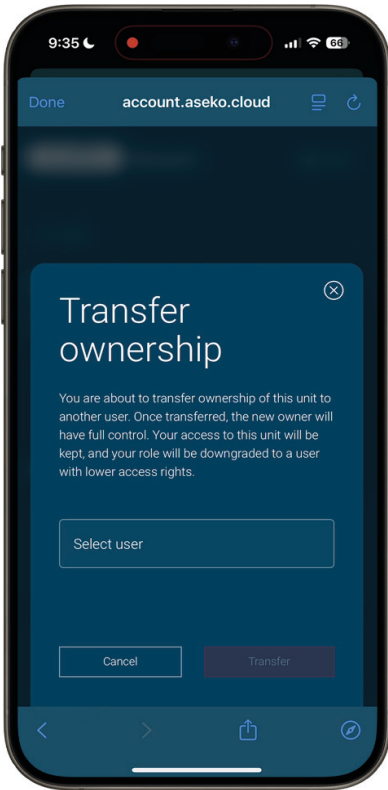

## Transfer of ownership

Open the unit detail and select the option to invite a new user. Then click on Edit users, which will open a browser window with the unit details. In this window, use the Transfer of ownership button to open a dialog box, where you enter the email address of the user to whom you want to transfer ownership. New owner has to be existing and invited user of your unit. You will also need to choose a new role for yourself, which will replace your current role as the owner. Once these details are filled in, simply confirm the transfer to complete the process.

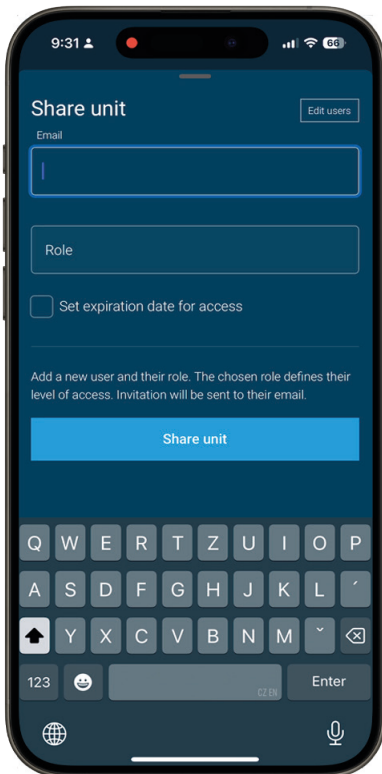

## Invite New User

Click the Invite New User icon to open a dialog where you can enter the email address of the person you want to invite. Assign one of the available roles and optionally set an access expiration date. After the expiration, access will be automatically revoked.

Role management can be done in the Account Settings under the Unit Details section. You can quickly access it from the invitation dialog via the Edit Users button.

## Roles

**Owner** – Full access to the unit, including settings and sharing. Only one owner per unit. Ownership changes can be done only through transfer of ownership.

**Admin** – Can operate the unit, change settings, and share access. Multiple admins are allowed.

**Technician** – Can operate and change settings but cannot share access.

**User** – Can operate the unit only; cannot change settings or share access.

**Viewer** – Read-only access for remote support. Cannot operate, change settings, or share access.

# Error messages

Those error messages appear when:

## Agent run out

- Check liquid levels on a regular basis, refill in time.

## Dosing pump does not dose

- Leakage in connection of PE tubes or they are damaged.
- Failure of dosing pump. Check whether pump is running. If so, check the hose inside the pump for damage or breakage and replace it, if required.

## Injection valve clogged

- Impassable spray valve.  
Check the valve for being clogged with impurities or deposits or the rubber seal for being damaged.
- Failure of dosing pump. Check whether pump is running.  
If so, check the hose inside the pump for damage or breakage and replace it, if required.

## No water flow to probe

- Check the measured water filter and clean it, if required.
- Check condition of connecting tubes from the extraction valve to the measured water inlet to probes and furthermore, from the water outlet from probes to the closing valve.
- Check condition of the extraction valve and the closing valve and their seals, for being clogged and their closed position.

## Probe out of service

- Measure pH using the hand tester. If the pH value is too low, a respective agent was overdosed due to an incorrect probe function (provided that other reasons given in the previous points have been excluded).
- Take the probe out and check it for mechanical damage.
- Clean the probe following the above procedure.
- It is recommended to replace the probes with the new probes every two years.

## The device has overheated

If the temperature in the device exceeds 65 ° C, electrolysis stops.

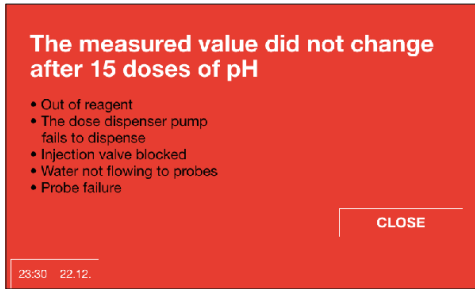

This error message appears after 15/30 doses of pH without probe reaction.

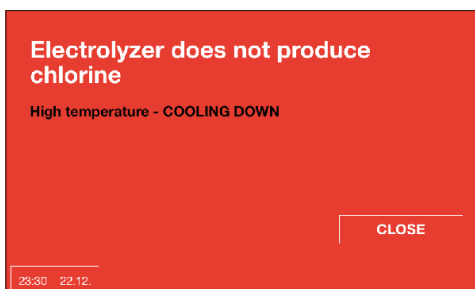

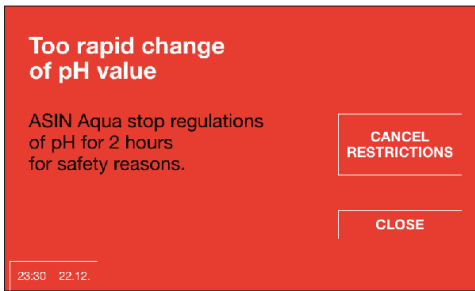

### Too rapid pH change

A sudden pH change is usually caused by refilling water directly into the skimmer. When this occurs, ASIN AQUA Eox Pro automatically pauses pH control for two hours.

This safety limit can be disabled manually, and normal operation resumes once the pH stabilizes or the two-hour period ends.

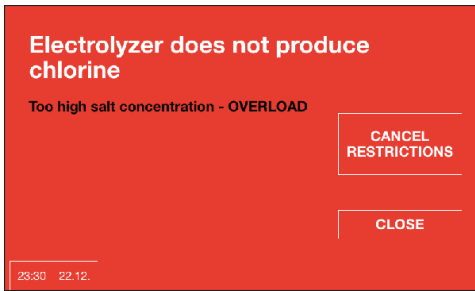

### Overload

If the recommended salt concentration is exceeded, the power supply is automatically interrupted.

### Low salt

Too low salt concentration in the water. Less than 1.5 kg/m<sup>3</sup>.

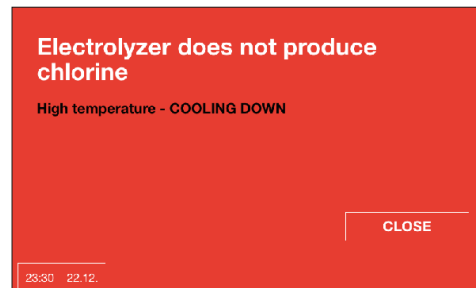
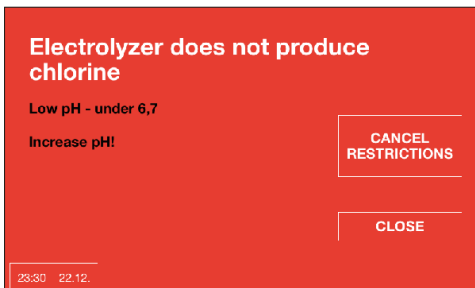

### Low pH

The pH value is below 6.7, increase the pH value.

### No water flow to probe

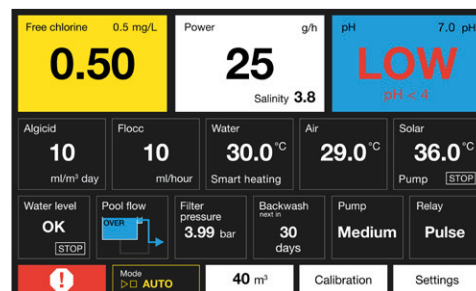
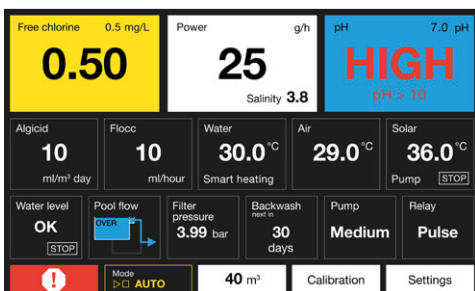

### The probe shows a pH > 10

Check the pool water and probe.

### The probe shows pH < 4

Check the pool water and probe.

# Connection ASIN AQUA Eox Pro to EXT Eox Pro

The ASIN Salt expansion module must be connected to the ASIN AQUA Eox Pro control unit with a cable.

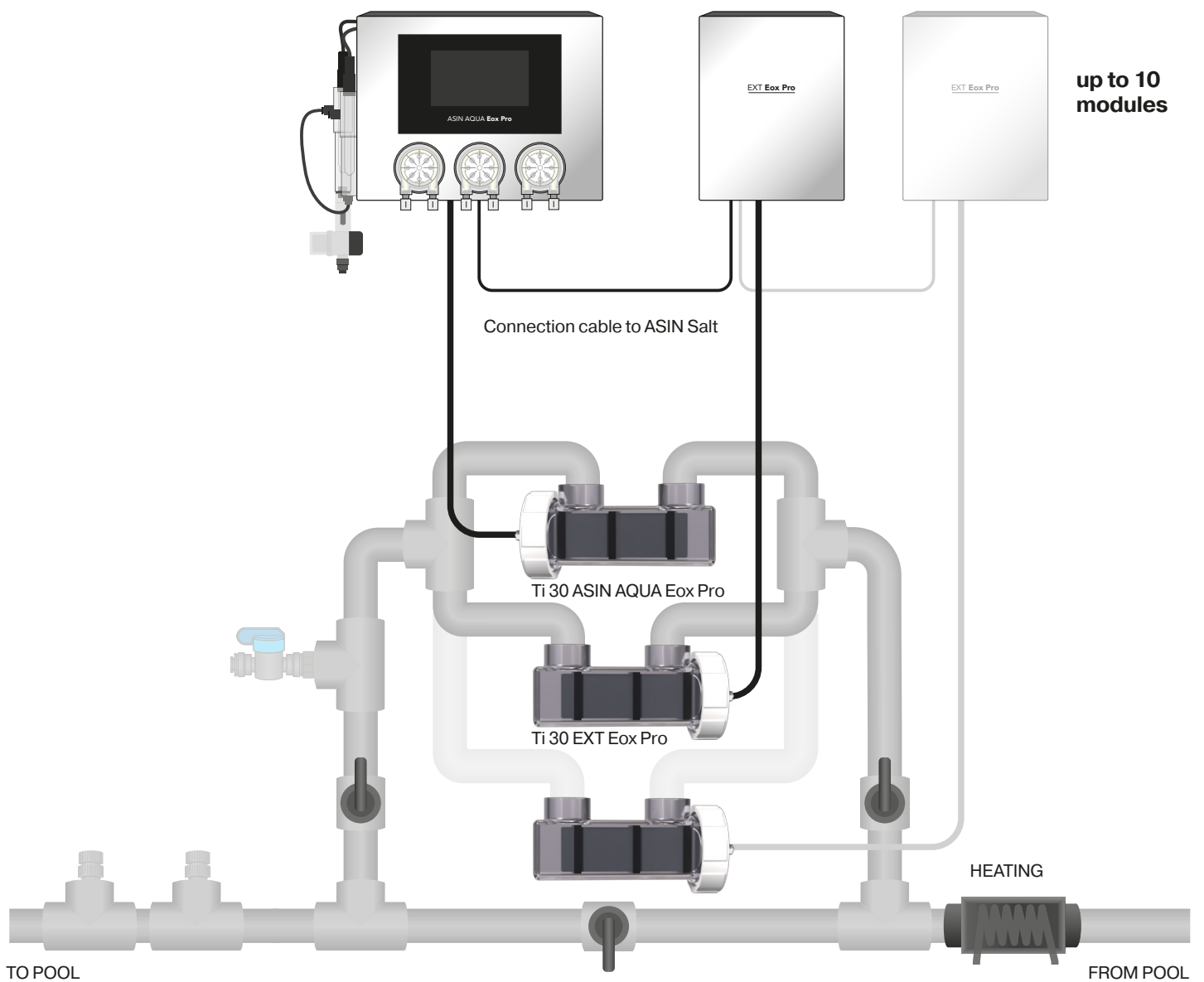

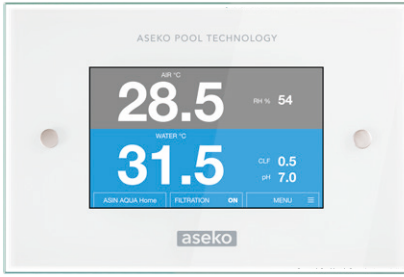

External Touchscreen Display #12048

## Externes touchscreen display

The external display shows

1. Pool water parameters:  
Temperature, pH value, redox potential or chlorine concentration.
2. Parameters of the air in the pool area:  
relative humidity and temperature.

The setpoints can be set on the ASIN AQUA Eox Pro device and a probe calibration can be carried out via the external display.

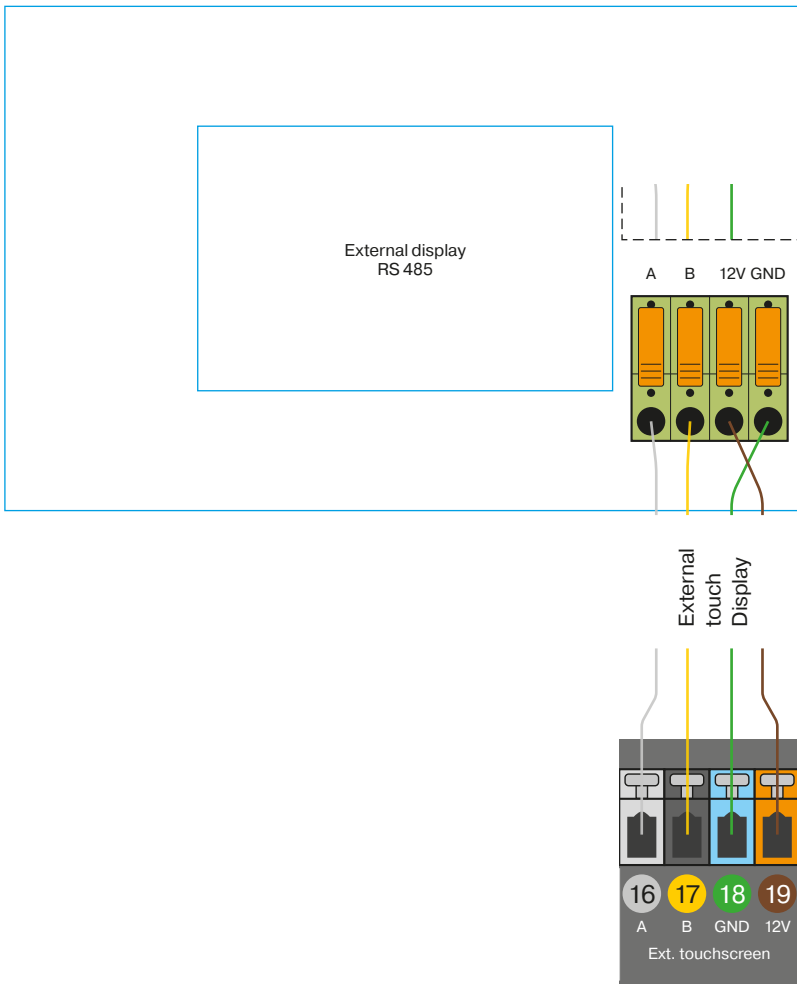

# RGB lights

The ASIN AQUA Eox Pro supports the DMX protocol to connect and control RGB lights (Duravision,EVA, compatibility with other manufacturers has to be discussed with the seller).

## 1. Enable DMX protocol RGB lights in the menu of the device

In the menu of the device, select the Serial line RS485 to be in DMX Protocol RGB lights mode.

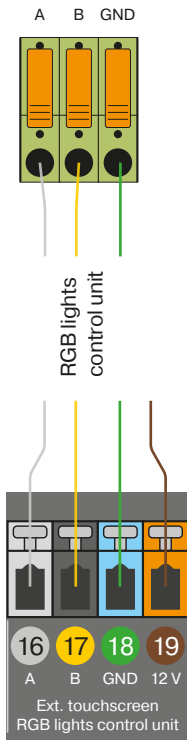
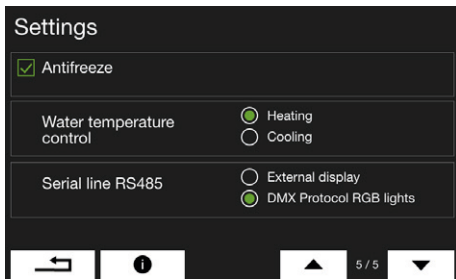

## 2. Connect light control unit with the RS485 output of ASIN AQUA Eox Pro

Connect the RS485 of ASIN AQUA Eox Pro with the DMX input on the motherboard of you light control unit according to the schem below.

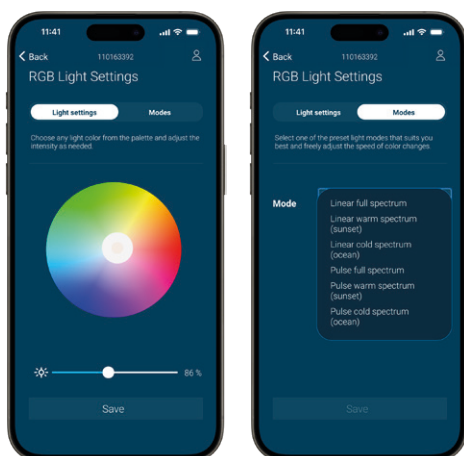

## 3. Open Aseko Remote app and to control the lights

RGB lights can only be controlled via Aseko Remote app. Select a color and save or use one of the preselected modes.





USER MANUAL

# ASIN AQUA **Eox Pro**

