

INVERTER POOL PUMP

RAPID X20 - VICTOR

INSTALLATION AND OPERATION MANUAL



CONTENTS

1. ⚠ IMPORTANT SAFETY INSTRUCTIONS.....	1
2. TECHNICAL SPECIFICATIONS.....	2
3. OVERALL DIMENSION (mm).....	2
4. INSTALLATION	3
5. SETTING AND OPERATION.....	5
6. WIFI OPERATION	15
7. EXTERNAL CONTROL	25
8. PROTECTION AND FAILURE.....	26
9. MAINTENANCE.....	32
10. WARRANTY & EXCLUSIONS.....	32
11. DISPOSAL.....	32

THANK YOU FOR PURCHASING OUR INVERTER POOL PUMPS.

THIS MANUAL CONTAINS IMPORTANT INFORMATION THAT WILL HELP YOU IN OPERATING AND MAINTAINING THIS PRODUCT.

PLEASE READ THE MANUAL CAREFULLY BEFORE INSTALLATION & OPERATION AND RETAIN IT FOR FUTURE REFERENCE.



1. IMPORTANT SAFETY INSTRUCTIONS

This guide provides installation and operation instructions for this pump. If you have any other questions about this equipment, please consult your supplier.

When installing and using this electrical equipment, basic safety precautions should always be followed, including the following:

- **RISK OF ELECTRICAL SHOCK.** Connect only to a branch circuit protected by a ground-fault circuit interrupter (GFCI). Contact a professionally trained and qualified electrician if you cannot verify that the circuit is protected by a GFCI.
- **TO PREVENT THE ELECTRICAL SHOCK RISK,** please connect the ground wire on the motor (green/yellow) to the grounding system.
- This pump is for use with permanently installed in-ground or above-ground swimming pools and may also be used with hot tubs and spas with a water temperature under 50°C. Due to its fixed installation method, this pump is not recommended for use on above-ground pools that can be readily disassembled for storage.
- The pump is not submersible.
- Never open the inside of the drive motor enclosure.

All installations must be fitted with earth leakage or residual current protection devices, having a rated residual operating current not exceeding 30mA.

WARNING:

- Fill the pump with water before starting. Do not run the pump dry. In case of a dry run, the mechanical seal will be damaged and the pump will start leaking.
- Before servicing the pump, switch power OFF to the pump by disconnecting the main circuit to the pump and releasing all pressure from the pump and piping system.
- Never tighten or loosen screws while the pump is operating.
- Ensure that the inlet and outlet of the pump are unblocked from foreign matter.

2. TECHNICAL SPECIFICATIONS

Model	P1	Voltage (V/Hz)	Qmax (m ³ /h)	Hmax (m)	Circulation (m ³ /h)	
	kW				at 10m	at 8m
RV22	1.00	220-240/ 50-60	27.0	19.0	21.0	24.0
RV27	1.50		31.0	21.5	27.5	30.5

3. OVERALL DIMENSION (mm)

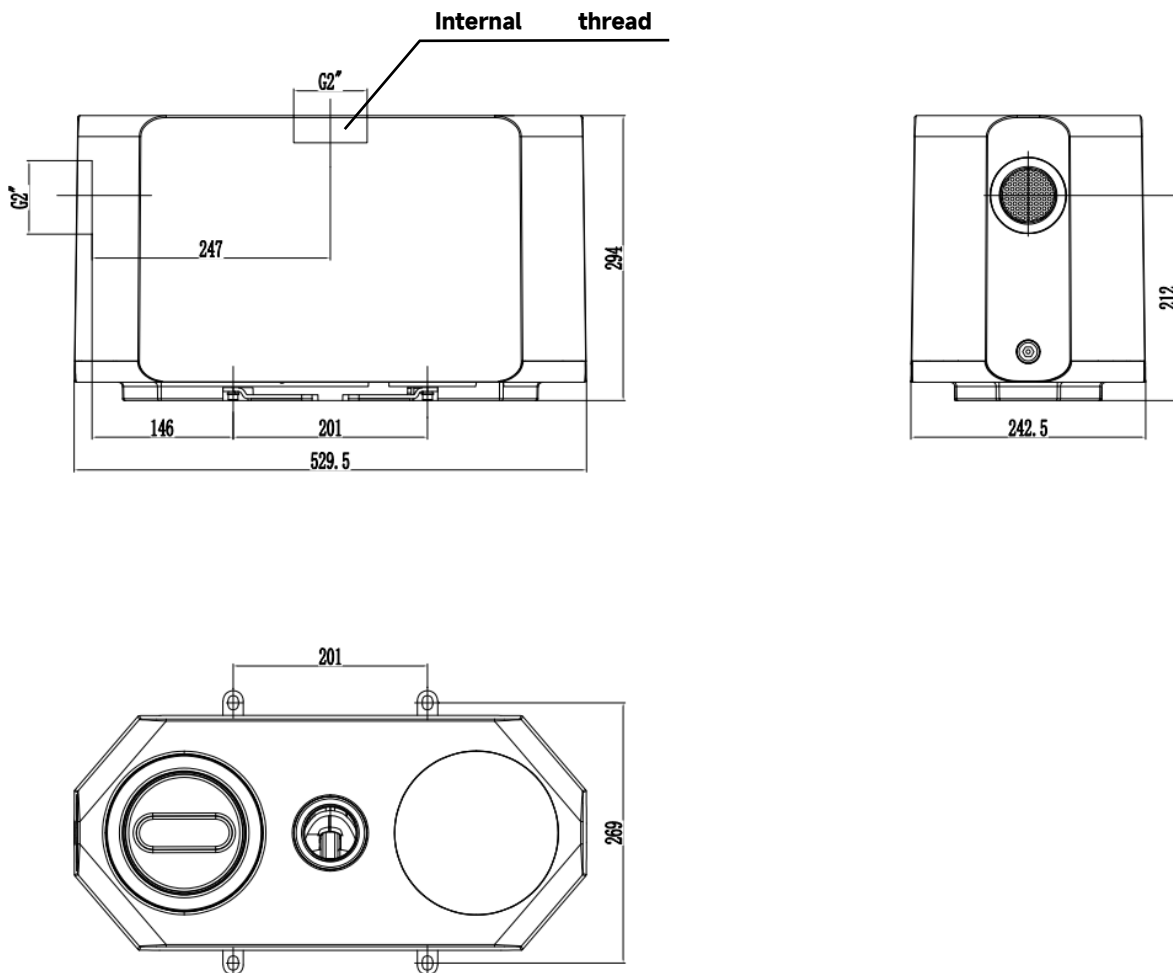

Figure 1 - Pump

4. INSTALLATION

4.1. Pump Location

- 1) Install the pump as close to the pool as possible, to reduce friction loss and improve efficiency, use short, direct suction and return piping.
- 2) To avoid direct sunshine, heat or rain, it is recommended to place the pump indoors or in the shade.
- 3) DO NOT install the pump in a damp or non-ventilated location.
- 4) The pump should be installed horizontally and fixed in the hole on the support with screws to prevent unnecessary noise and vibration.

4.2. Plumbing and Valves

- 1) The pump inlet/outlet union size: optional with 48.3/50/60.3/63mm.
- 2) For optimization of the pool plumbing, a larger pipe size should be used. It is recommended to use a pipe with size of 63mm.
- 3) When installing the inlet and outlet fittings (joints) with the plumbing, use the special sealant for PVC material.
- 4) The dimension of suction line should be the same or larger than the inlet line diameter, to avoid pump sucking air, which will affect the pump's efficiency.
- 5) To reduce friction loss and improve efficiency, plumbing on the suction and return side should be short and direct.
- 6) Flooded suction systems should have valves installed in both the pump suction and return line, which is convenient for routine maintenance. A valve, elbow, or tee installed on the suction line should be no closer to the front of the pump than seven times the suction line diameter.
- 7) Use a check valve in the return line where there is a significant height between the return line and the outlet of the pump, to prevent the pump from the impact of medium recirculation and pump-stopping water hammer.

4.3. Fittings

- 1) Elbows should be no closer than 350mm to the inlet. Do not install 90° elbows directly into the pump inlet/outlet.
- 2) Joints must be tight.

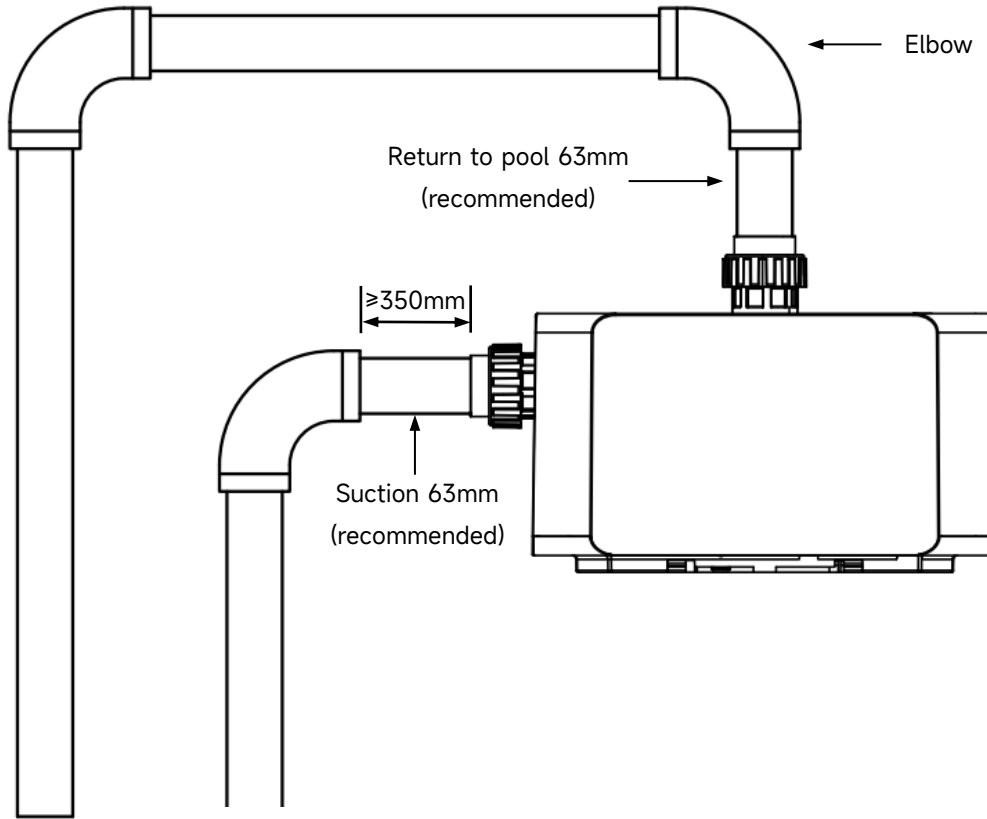

Figure 2 - Plumbing and Fittings

* The pump inlet/outlet union size: optional with 48.3 / 50 / 60.3 / 63mm

- 3) Use the UNION KIT supplied by the pump manufacturer (Refer to Figure 3). Do not use fittings other than those provided to connect the pump inlet/outlet, as incompatible fittings may damage the pump body.

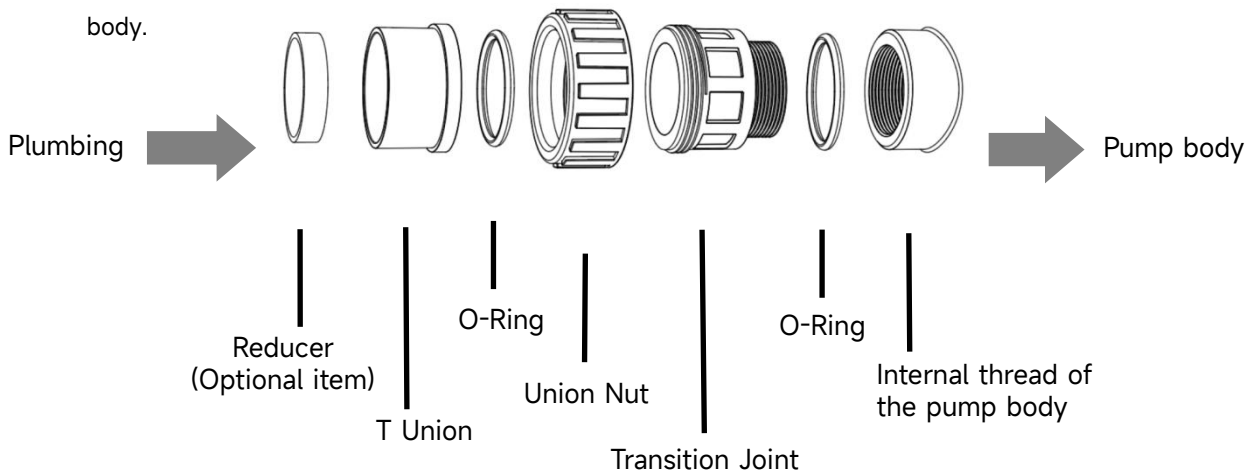

Figure 3 - Union Kit

4.4. Check before initial startup

- 1) Check whether pump shaft rotates freely;
- 2) Check whether power supply voltage and frequency conform to the nameplate;
- 3) It is forbidden to run the pump without water.

4.5. Application conditions

Ambient temperature	Indoor installation, temperature range: -10 - 42°C
Maximum water temperature	50°C
Salt pools	Salt concentration up to 3.5%, i.e 3.5g/l
Humidity	≤90% RH, (20°C±2°C)
Installation	The pump can be installed max. 2m above water level
Protection	Class F, IP55

5. SETTING AND OPERATION



5.1. Display on control panel

	① Power consumption
	② Flow rate / Running capacity
	③ Running capacity
	④ WIFI indicator
	⑤ Unit of flow
	⑥ Timer period
	⑦ Timer 1/2/3/4
	Backwash/unlock
	Up/down: to change the value of setting
	Switch between Manual Inverter Mode and Auto Inverter Mode. Manual Inverter Mode: The running capacity will be set manually between 30 - 120 %. Auto Inverter Mode: The running capacity will be automatically adjusted between 30 - 120 % according to the preset flow rate. The default mode is Manual Inverter mode.
Timer setting	
On/off	

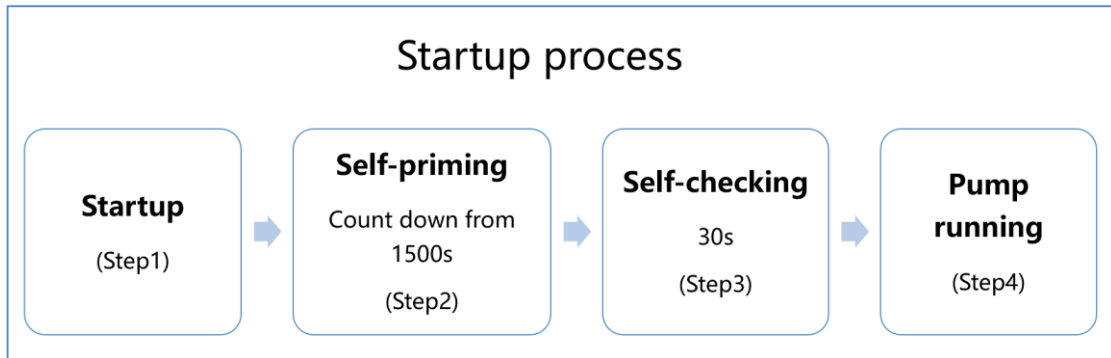
5.2. Startup process overview



① Step1: Startup

- Press and hold  for more than 3 seconds to unlock the screen.
- Press  to startup the pump.

② Step2: Self-priming

- The pump will start counting down from 1500s; When the system detects the pump is full of water, it will stop counting down and exit priming automatically.
- Users can enter the parameter setting to disable the default self-priming function (see 5.11).

③ Step3: Self-checking



- The pump will recheck for 30s again to make sure the self-priming (Step2) is completed.



④ Step4: Pump running

- The pump will run at 80% of the running capacity at the initial startup after the self-priming.

5.3. Startup

When the power is switched on, the screen will fully illuminate for 3 seconds, displaying the device code, and then it will enter its normal working state.

When the screen is locked, only the button  and  will light up;

Press and hold  for more than 3 seconds to unlock the screen. The screen will automatically lock up when there is no operation for more than 1 minute and the brightness of the screen will be reduced to 1/3 of the normal display. Short press  to wake up the screen and observe the relevant operating parameters.



5.4. Self-priming

Each time the pump is started, it will start self-priming.

When the pump performs self-priming, it will start counting down from 1500 s and stop counting down automatically when the system detects the pump is full of water. Then, the system will recheck for 30 seconds again to ensure the self-priming is completed.



Users can cancel self-priming manually by pressing  for more than 3 seconds. The pump will enter the default Manual Inverter mode at the initial startup.

Remark:

- 1) The pump is delivered with self-priming enabled. Each time the pump restarts, it will perform self-priming automatically. Users can enter the parameter setting to disable the default self-priming function (see 5.11)
- 2) If the default self-priming function is disabled, and the pump has not been used for a long time, the water level in the strainer basket may drop. Users can manually activate the self-priming function by pressing both   for 3 seconds, the adjustable period is from 600 s to 1500 s (default value is 600 s).
- 3) After the manual self-priming is completed, the pump will return to the previous state before activating the manual self-priming.
- 4) Users can press  for more than 3 seconds to cancel the manual self-priming.

5.5. Backwash











Users can start the backwash or fast re-circulation in any running state by pressing .

	Default	Setting range
Running Time	180 s	Press  or  to adjust from 0 to 1500 s with 30 seconds for each step
Running capacity	100 %	60 – 100 %, enter the parameter setting (see 5.11)

Exit backwash:

When backwash mode is on, users can hold  for 3 seconds to cancel it, the pump will return to the previous state before backwash. If the users set a speed limit, the running capacity of the backwash will not exceed the set speed limit. (see 5.10)

5.6. Manual Inverter Mode













1		Hold  for more than 3 seconds to unlock the screen.
2		Press  to start. The pump will run at 80 % of the running capacity at the initial startup after the self-priming.
3	 	Press  or  to set the running capacity between 30 - 120 %, each step by 5 %.
4		Press  again to switch to Auto Inverter mode.

Note:

- 1) When the pipeline pressure is high, to maintain an adequate flow rate, users can set the running capacity to 105 – 120 %. The pump will run at a higher speed to overcome the high pipeline pressure.
- 2) At the range of 105%-120% running capacity, the pump will automatically adjust the speed when it reaches the maximum power.
For example, when the users adjust the speed to 110 %, if the pump power has reached the maximum value at this speed, at this time, even if the users continue to increase the pump speed to 120 %, the pump will maintain the speed at the maximum power, i.e., 110 %. And the display speed will drop from 120 to 110 %.

5.7. Auto Inverter Mode

Under Auto Inverter Mode, the pump can automatically detect the system pressure and adjust the speed of motor to reach the set flow.











1		Unlock the screen, press  to switch from the Manual Inverter mode to Auto Inverter mode.
2	 	The flow rate could be adjusted, by pressing  or  with 1 m ³ /h for each step.
3	 	The unit of flow rate could be changed to l/min or gpm, by pressing both   for 3 seconds.
4		Press  to switch to Manual Inverter mode.

The default adjustable flow range for Rapid Victor is as below:





Model	Default adjustable flow rate range
RV22	8 - 28 m ³ /h
RV27	8 - 30 m ³ /h

5.8. Timer mode

The pump's on/off and running capacity can be controlled by a timer, which can be programmed daily as needed.

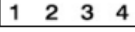
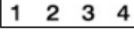

1	Enter timer setting by pressing 
2	Press  or  to set the local time.
3	Press  to confirm and move to time-1 setting.
4	Press  or  to choose the desired running periods, running capacity or flow rate (when % icon is flashing, users can change to set the flow rate by pressing ).
5	 Repeat above steps to set the other 3 timers.
6	 Hold 3 seconds to save setting and activate timer mode.
7	 or  Check 4 timers to make sure there is no invalid setting.



Note:

- 1) If the set time period contains the current time, the pump will start running according to the set running capacity or flow rate, the current timer indicator  (1 or 2 or 3 or 4) will light up, and the area **88:88-88:88** will display the corresponding time period.
- 2) If the set time period does not contain the current time, the timer number  (1 or 2 or 3 or 4) that is about to start running will be displayed and flash, and the area **88:88-88:88** will display the corresponding time period.
- 3) During timer setting, if you want to return to the previous setting, hold both   for 3 seconds. If you don't need to set all 4 timers, you can hold  for 3 seconds, the system will automatically save the current set value and activate the timer mode.
- 4) The timer settings of the pump have been limited, users will not set the overlapping timers.
- 5) After the timer is set and then users turn off the pump, when users turn on the pump again, it will continue to return to the timer mode.
- 6) Users can cancel the timer mode by pressing .

5.9. Skimmer Mode

The skimmer mode enables the pump to skim the water surface, prevents the debris from accumulating, and provides users with a cleaner pool.

Hold  and  to enter the preset interface of the skimmer mode. When first switching to this mode, preset 1 will be activated.

Users can press  or  to view the 4 presets, the details of each preset are as below, the selected preset will be activated after 5 s without operation.

Preset	Skimmer cycle	Skimmer duration	Skimmer speed	Time period	Remark
1	1 h	3 mins	100 %	7:00 – 21:00	Editable in parameter setting
2	1 h	10 mins	100 %	7:00 – 21:00	Not editable
3	3 h	3 mins	80 %	7:00 – 21:00	Not editable
4	Turn off the skimmer mode				Not editable

At the skimmer duration, the controller displays the preset parameter. Users can hold  to cancel the skimmer duration each time. When the skimmer duration ends, the pump will return to its normal state, allowing users to operate it again.

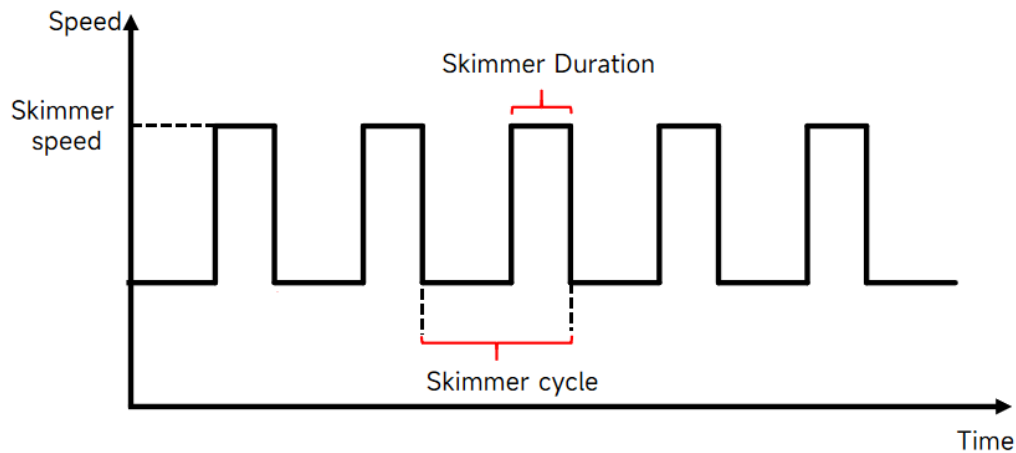
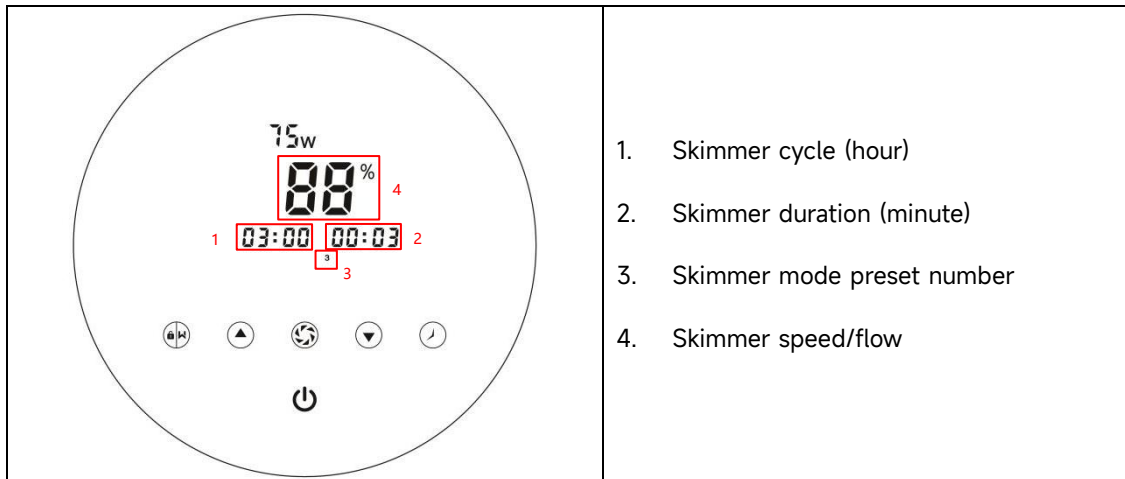

Figure 4 - Skimmer cycle

5.10. Speed / Flow Limit

Users can set the speed limit or flow rate for the pump to meet the flow requirements of other equipment, such as sand filters.

Speed/flow limit of the pump can be set in the parameter setting. (see 5.11)







100 % means no speed limit, and the running capacity can be set from 30 to 120% under regular operation.

Model	Speed / Flow limit	
	Maximum Running Speed	Maximum Flow Rate
RV22	60 ~ 100 %	17 ~ 28 m ³ /h
RV27	60 ~ 100 %	18 ~ 30 m ³ /h



To ensure the performance, the following process will not be limited by the Speed / Flow limit function:



1. Self-priming at each start
2. Manual self-priming

5.11. Parameter Setting





Restore factory settings	Switch off the pump, then hold both   for 3 seconds.
Check the software version	Switch off the pump, then hold both   for 3 seconds.
Enter parameter setting as below	Switch off the pump, then hold both   for 3 seconds; If the current address does not need to be adjusted, press the following address.

Parameter Address	Description	Default Setting	Setting Range
1	Di2 (Digital input 2)	Speed: 100%	Speed: 30 – 120 %, by 5% increments; Flow: by 1 m ³ /h increments; RV22: 8 – 28 m ³ /h RV27: 8 – 30 m ³ /h
2	Di3 (Digital input 3)	Speed: 80%	

3	Di4 (Digital input 4)	Speed: 40 %	Note: Press  to switch to flow rate setting
4	Backwash	Speed: 100 %	Speed: 60 - 100 %, by 5 % increments; Flow: by 1 m ³ /h increments; RV22: 8 - 28 m ³ /h RV27: 8 - 30 m ³ /h Note: Press  to switch to flow rate setting
5	Pump control	0	0: Only the panel takes effect, and other external controls are invalid 1: Panel + analog current input takes effect 2: Panel + analog voltage input takes effect 3: Panel + digital input takes effect 4: Panel + RS485 input takes effect
6	Enable or disable the self-priming at each start	0	25: enables 0: disables
7	Reserved	0	Not editable
8	System time	00:00	00:00 - 23:59
9	Preset 1 of the skimmer mode	Skimmer cycle: 01:00 Skimmer duration: 00:03 Skimmer speed: 100%	Skimmer cycle: 1 ~ 24 h, 1 h for each step; Skimmer duration: 1 ~ 30 min, 1 min for each step; Skimmer speed: 30 ~ 100 %, by 5 % increments; Skimmer flow: by 1 m ³ /h increments; RV22: 8 - 28 m ³ /h RV27: 8 - 30 m ³ /h

			Note: Press  to switch to flow rate setting
10	Time period of the preset 1 of the skimmer mode	7:00 - 21:00	Start time: 00:00 - 24:00 End time: 00:00 - 24:00
11	Speed limit	Speed: 100 %	Speed: 60 – 100 %, by 5 % increments; (100 % means no speed limit) Flow: by 1 m ³ /h increments; RV22: 17 – 28 m ³ /h RV27: 18 – 30 m ³ /h Note: Press  to switch to flow rate setting
12	RS485 address	170 (0xAA)	160 – 190 (0xA0 - 0xBF), each step by 1.
13	Reserved	0	Not editable

For example: How to Enable / Disable Self-Priming Function?

- 1) **Enter parameter setting:** Switch off the pump, then hold both   for 3 seconds;
- 2) **Select parameter address:** Press  to select address 6;
- 3) **Enable or disable the self-priming function:** Adjust by pressing  or , 25= Enables, 0=Disables.

6. WIFI OPERATION

① Download iGarden APP



Android



iOS



② Account Registration

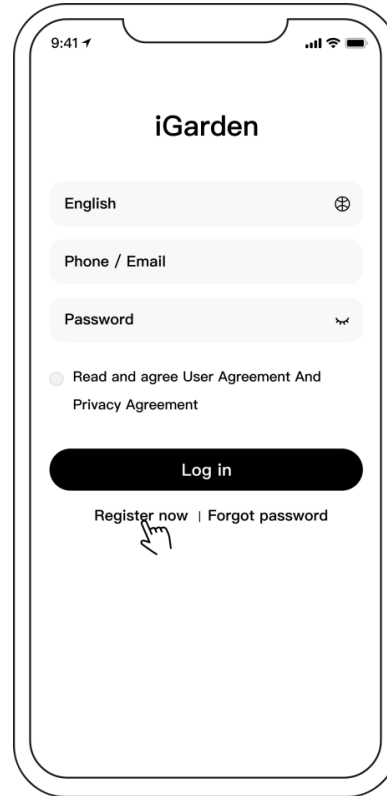

Phone / Email Registration

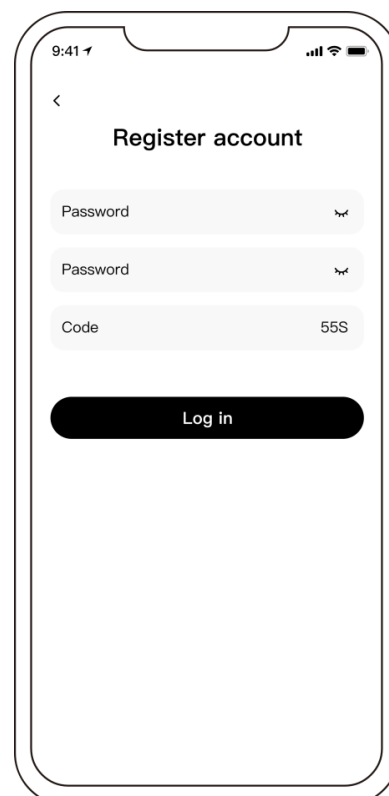
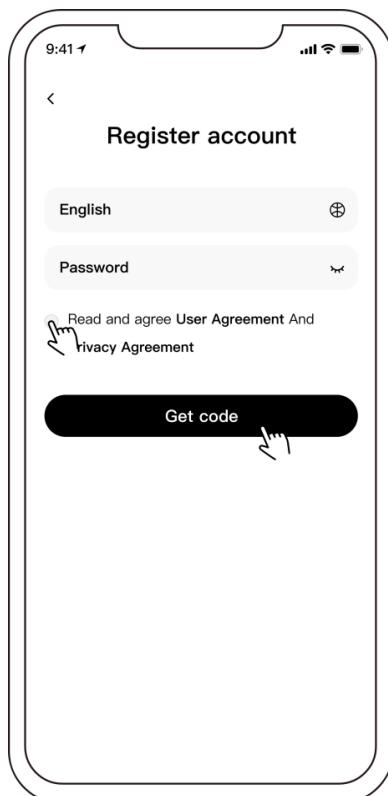

3 App Pairing

Please make sure your pump is turned on before you start.

Option 1 (Recommended): With Wifi and Bluetooth

(Network requirement: 2.4GHz; 2.4Ghz and 5GHz into one SSID; but no separate 5GHz network)

1) Please confirm that your phone is connected to Wifi and your Bluetooth is on.

2) Press  for 3 seconds to unlock the screen. After switching on the pump, press  for 5 seconds

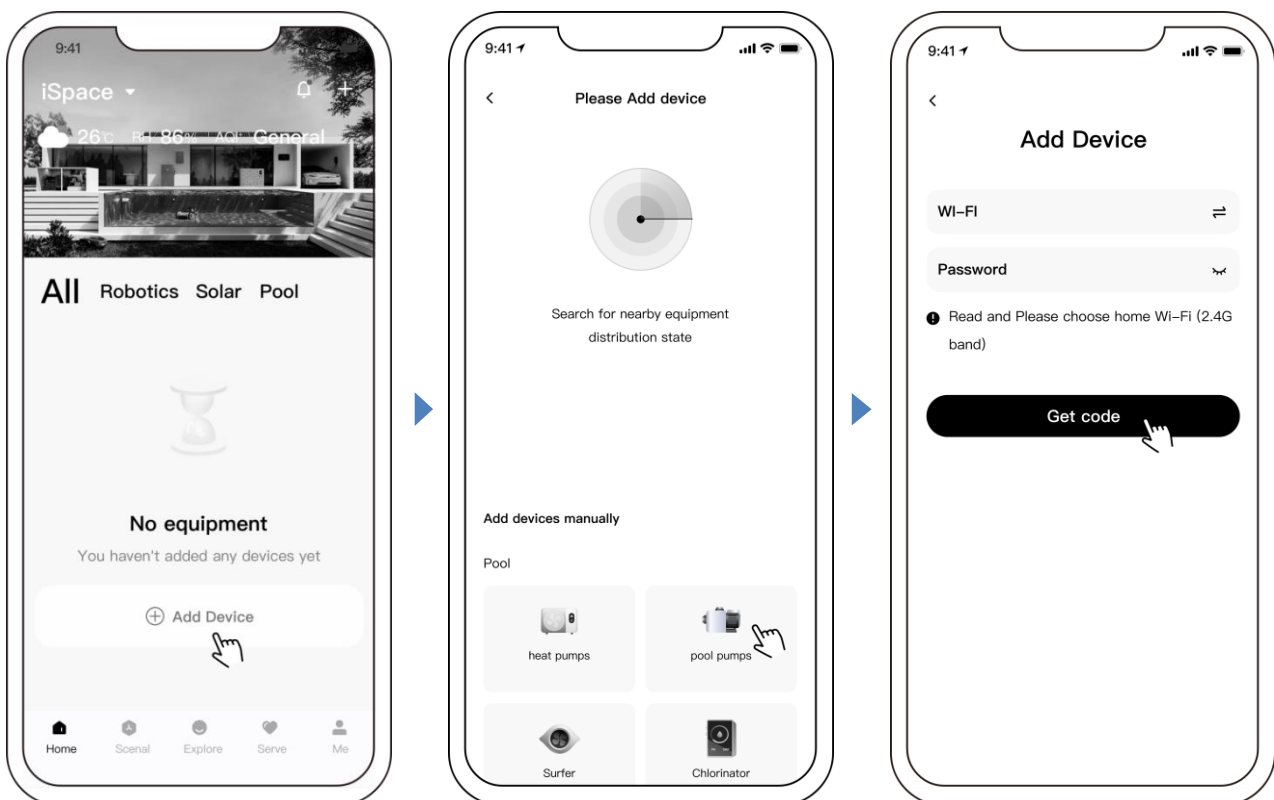

until hearing “Beep” and then release.  will flash.

3) Click “Add Device”, and then follow the instructions to pair device.

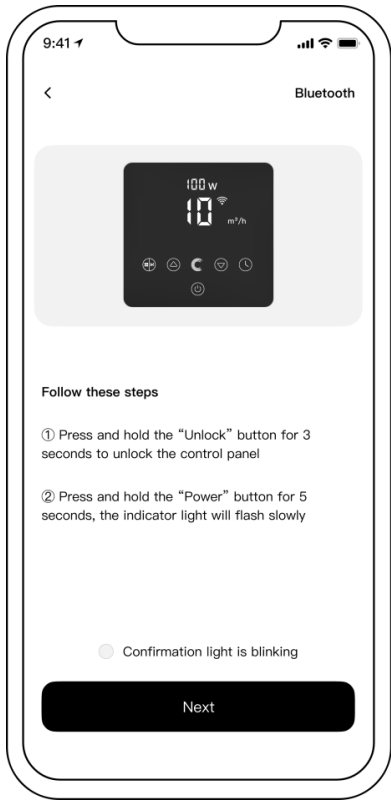



Option 2: With Wifi (Network requirement: 2.4GHz only)

- 1) Please confirm that your phone is connected to Wifi.
- 2) Press  for 3 seconds to unlock the screen. After switching on the pump, press  for 5 seconds until hearing “Beep” and then release.  will flash.
- 3) Click “Add Device”, and then follow the instructions to pair device.

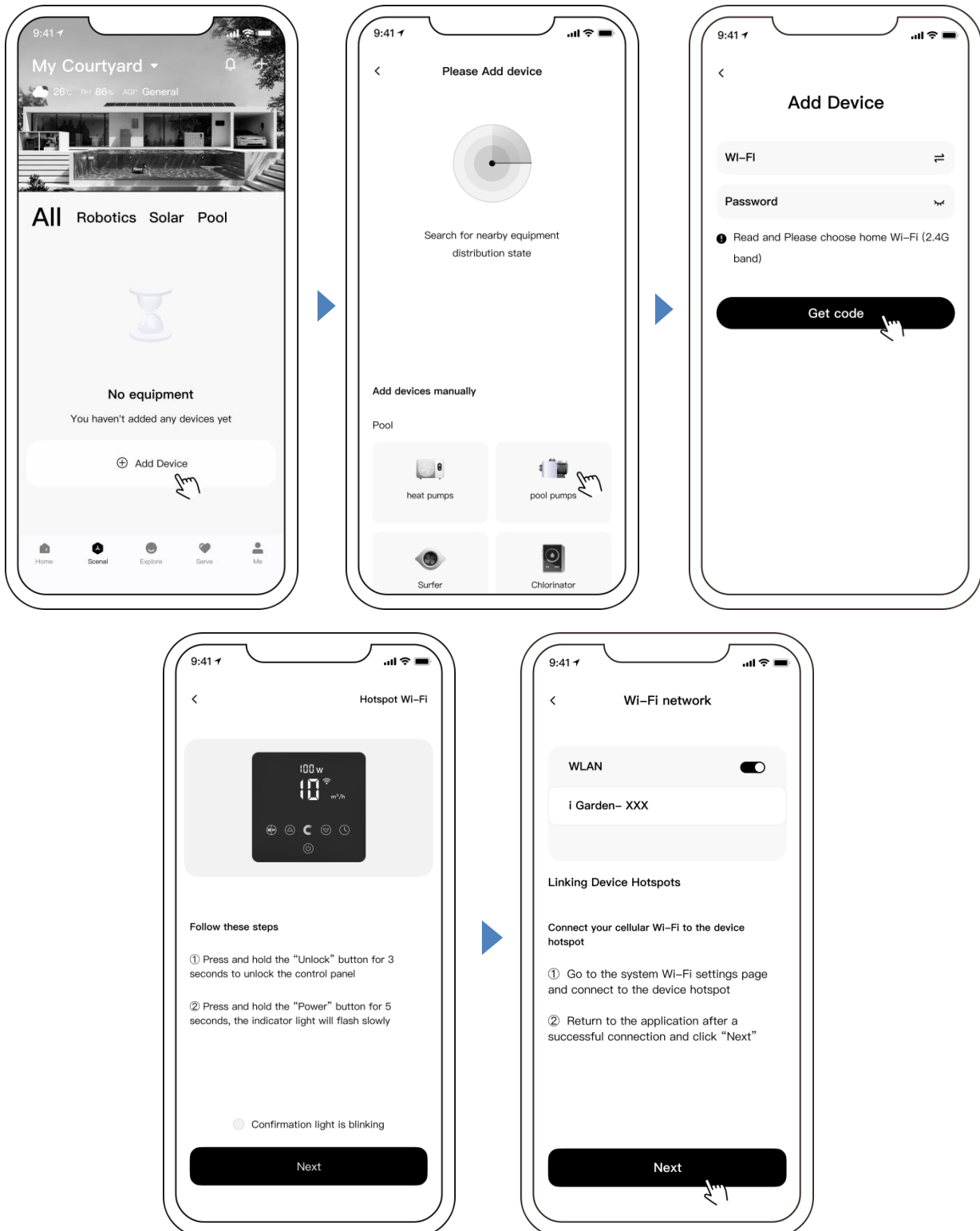

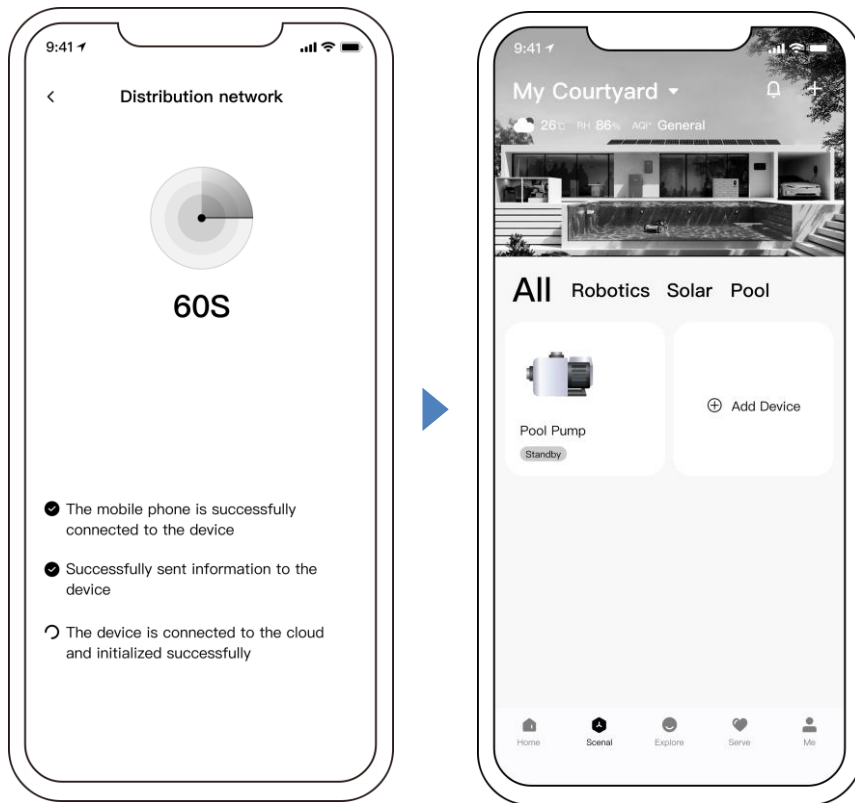

4 Garden Management

In the device list, the current courtyard is displayed. After clicking, you can view/switch to all the current courtyards, click Garden Management, and you can also enter the courtyard list page. As shown below:

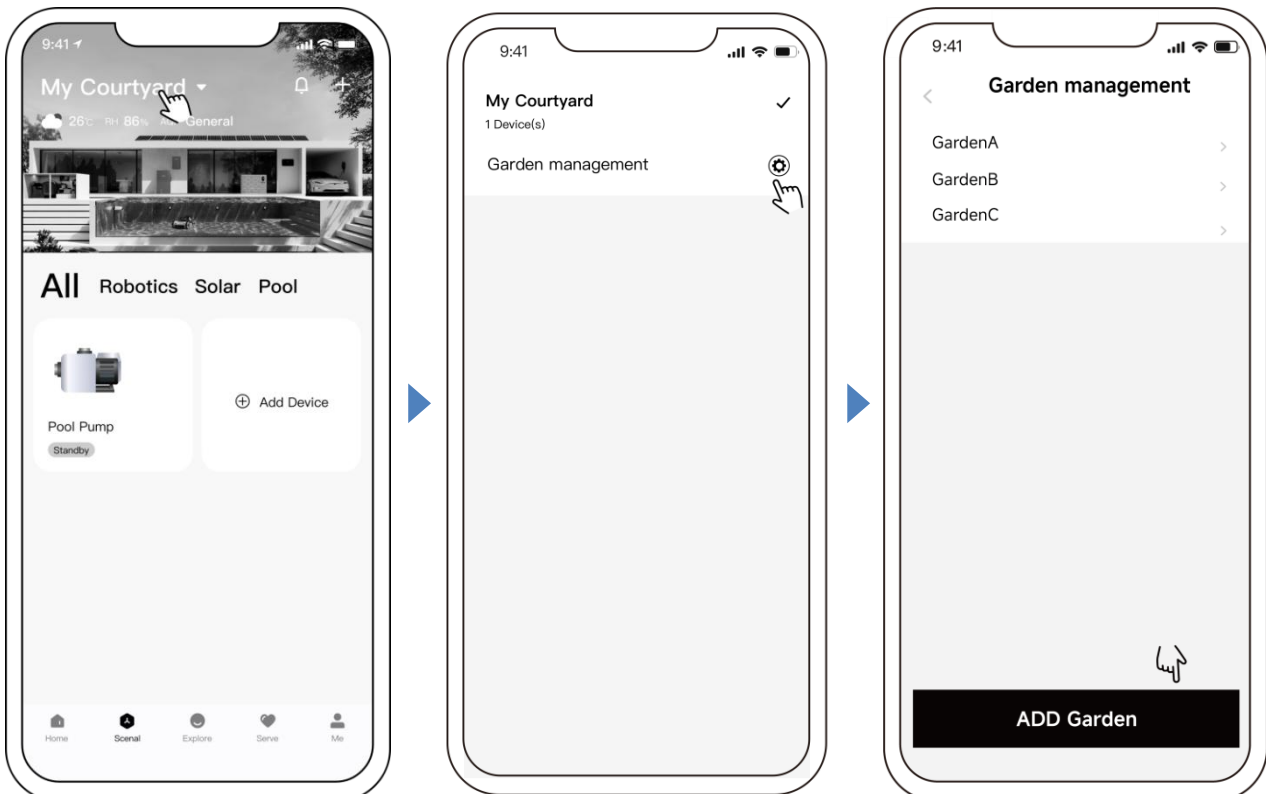

5 Operation

1) Using Auto Inverter mode:

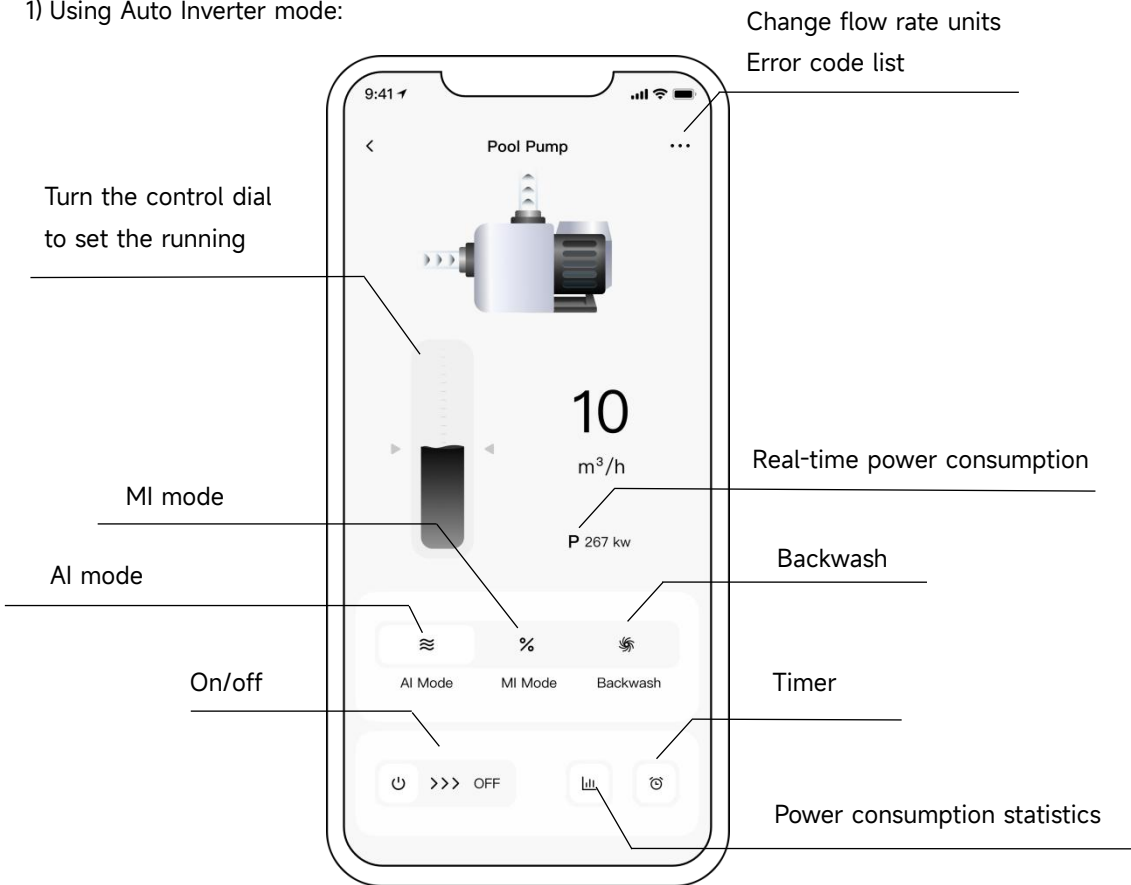

2) Using Manual Inverter mode:

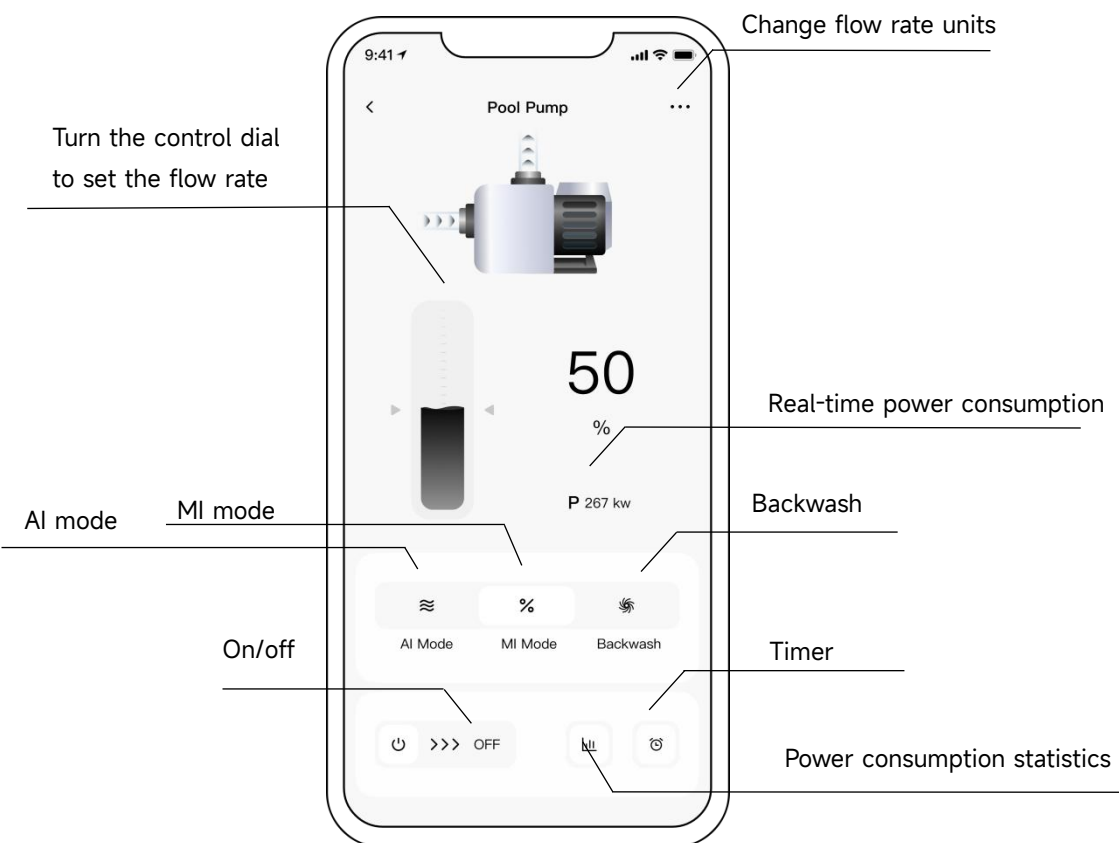

3) Backwash mode:

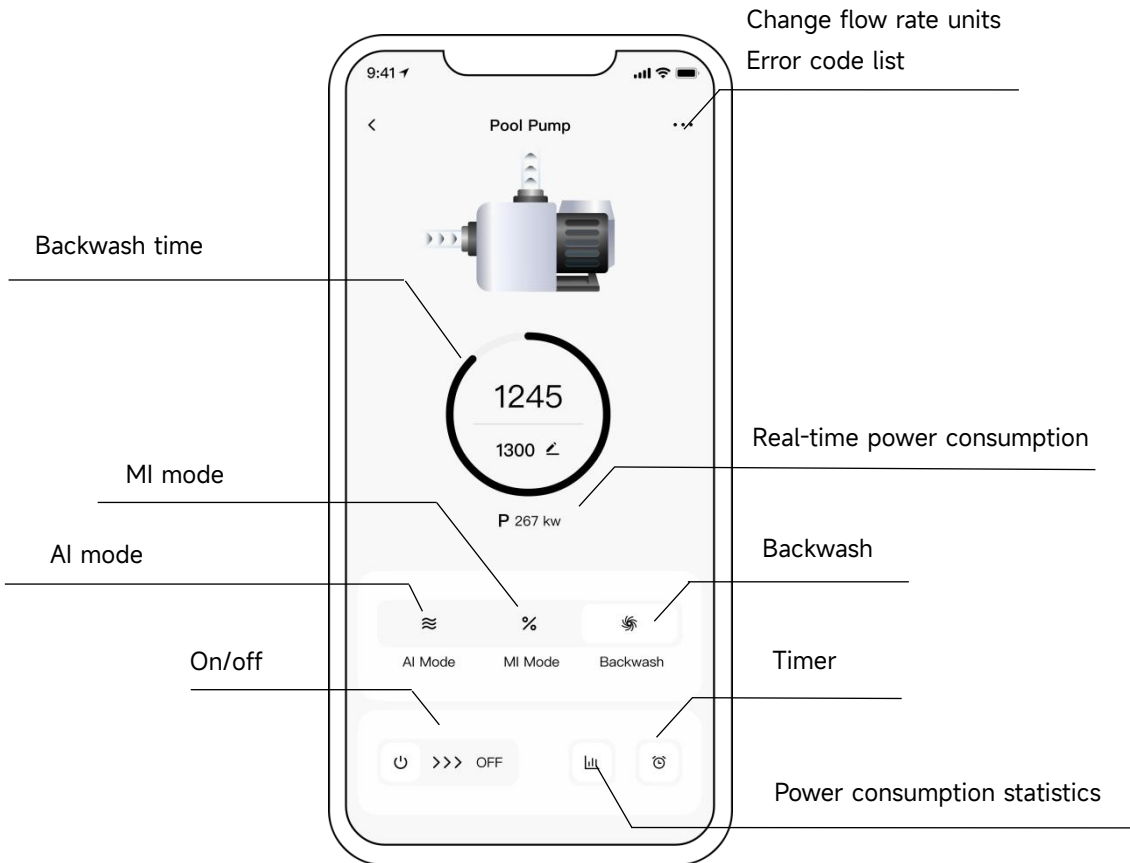

Notice for the timer setting via the APP:

- 1) Time variance is $\pm 30s$;
- 2) In order to avoid overlapping timing points conflicting and invalidating due to network delay, it is recommended that the end time and the start time of the next timing period cannot overlap, and a sufficient time interval should be reserved, for example, at least 2 minutes;

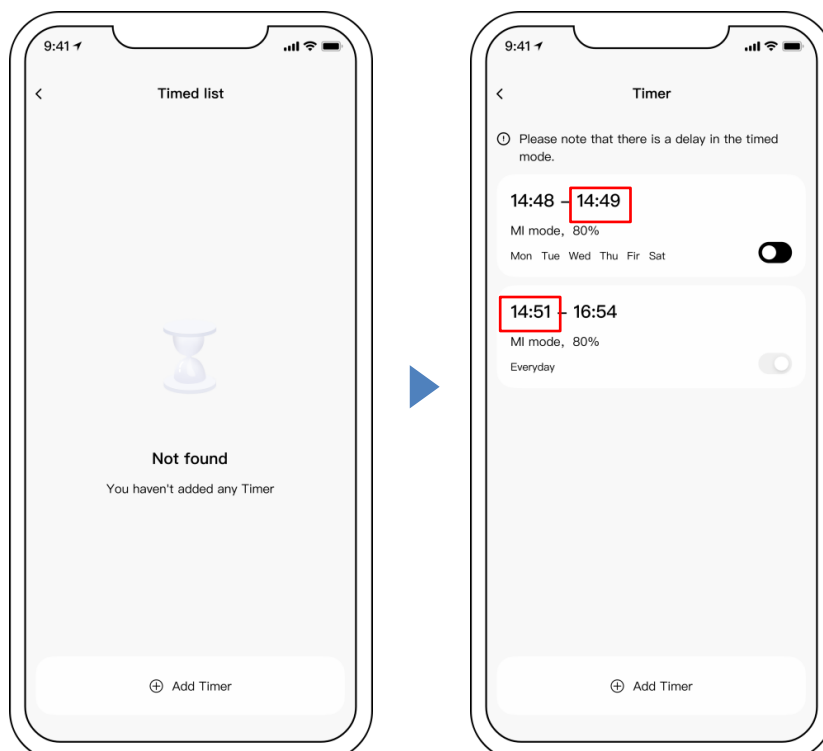

6 Sharing Devices with your family members

Users can share their devices to be controlled by their family members. Please let your family members register “iGarden” first, and then the administrator can operate as below:

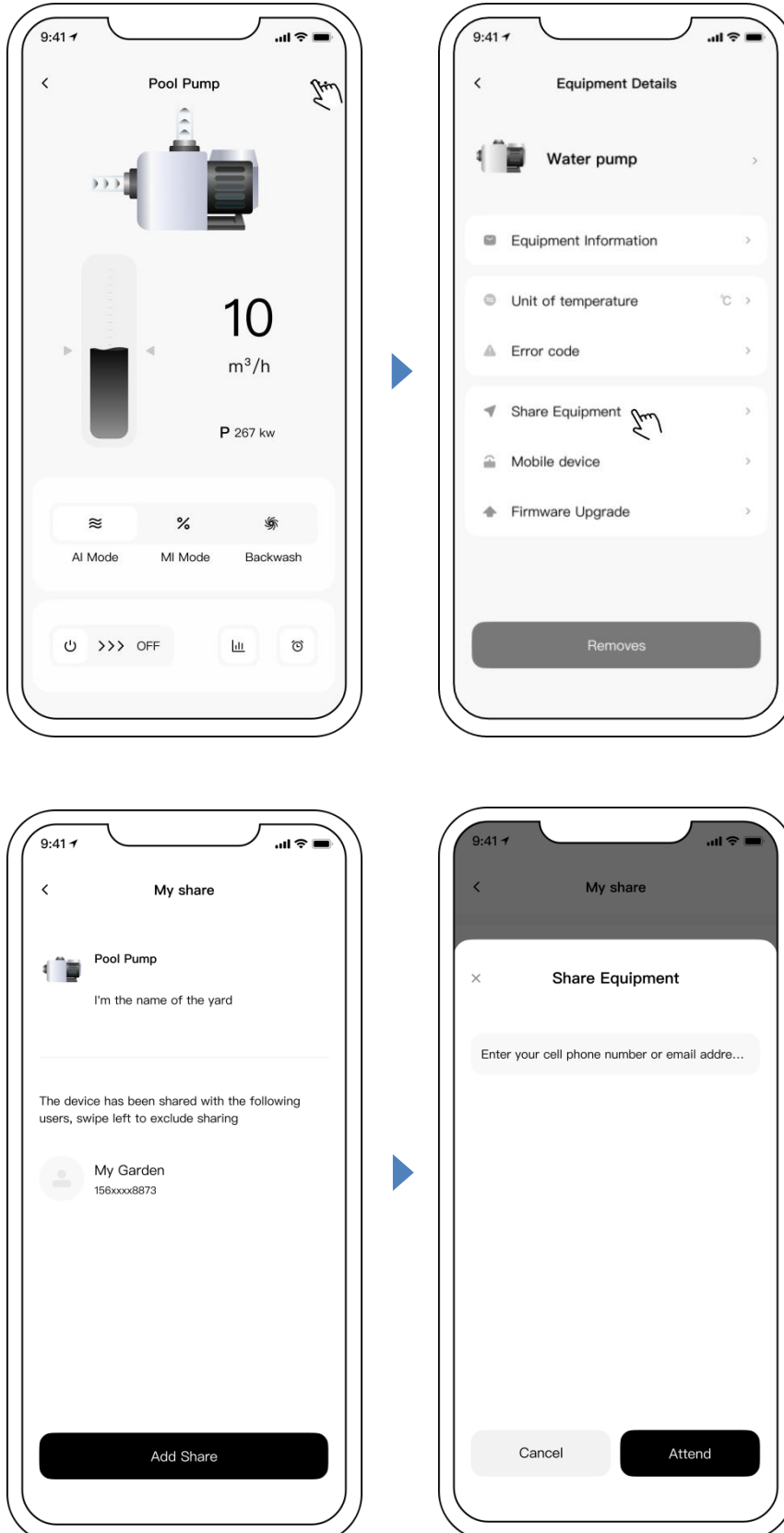

7 Message Center

A: View Message: On the device list page, click the message icon to enter the message center and view the corresponding message, as shown below: (Including: Alarm, Garden, Notify)

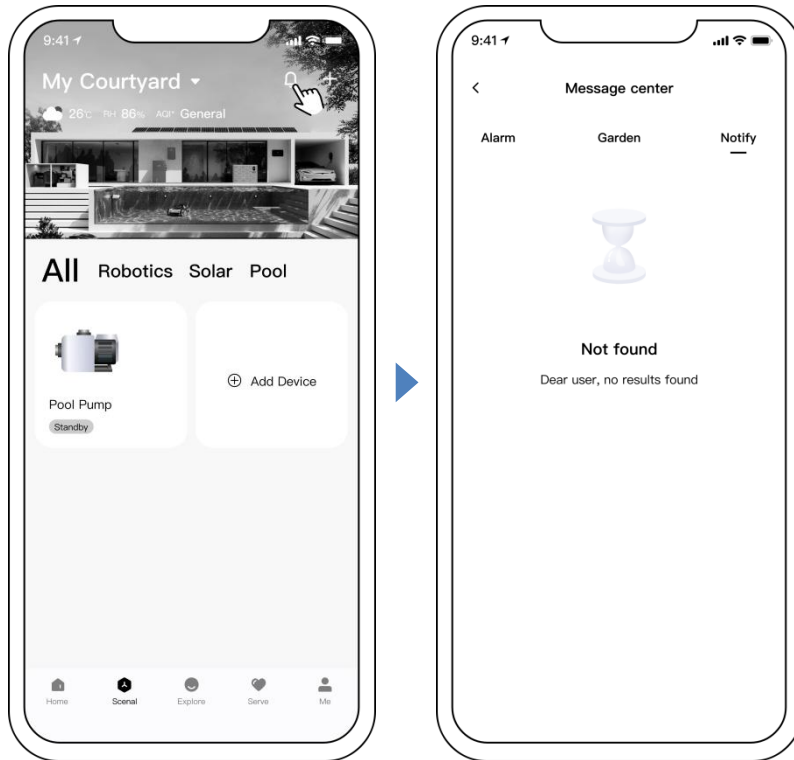

B: Push Settings: On the Settings page, click [Push Settings] to enter the Push Settings page. You can set the push settings according to the message classification, as shown below:

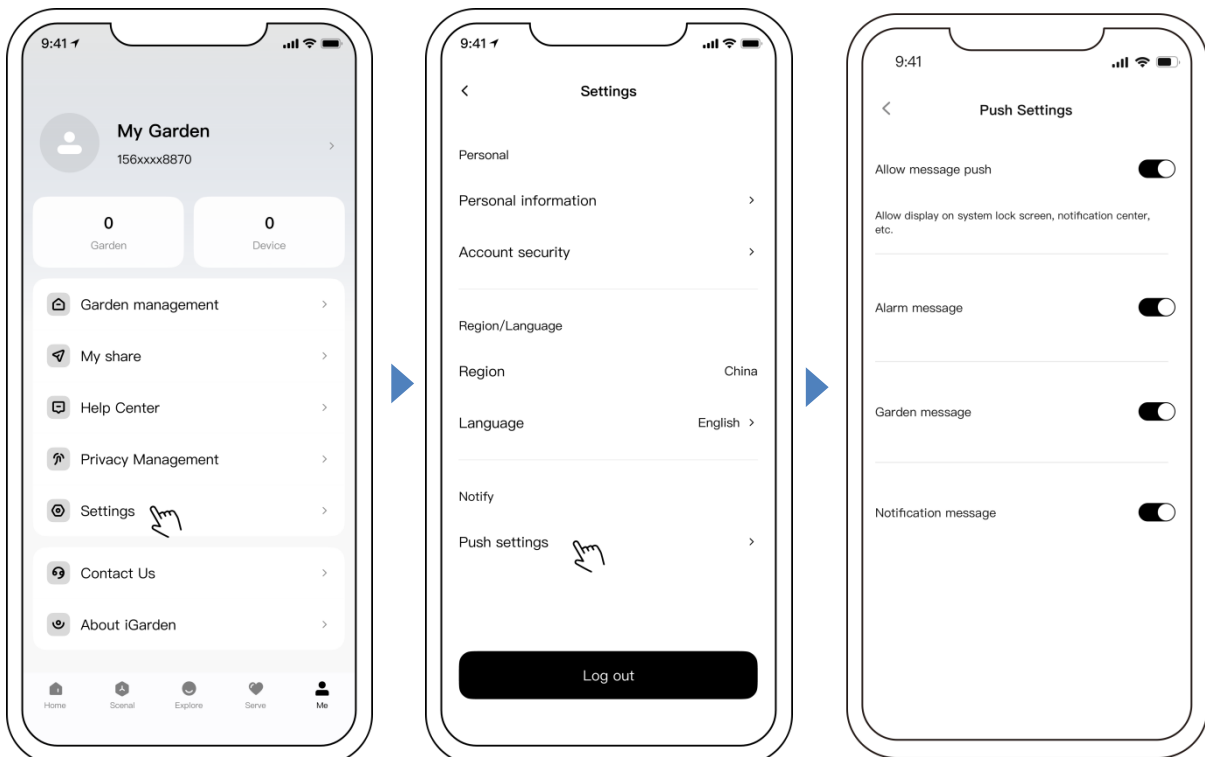

8 Feedback

If you have any problems while using, feel free to send feedback to us. The process is as follows:

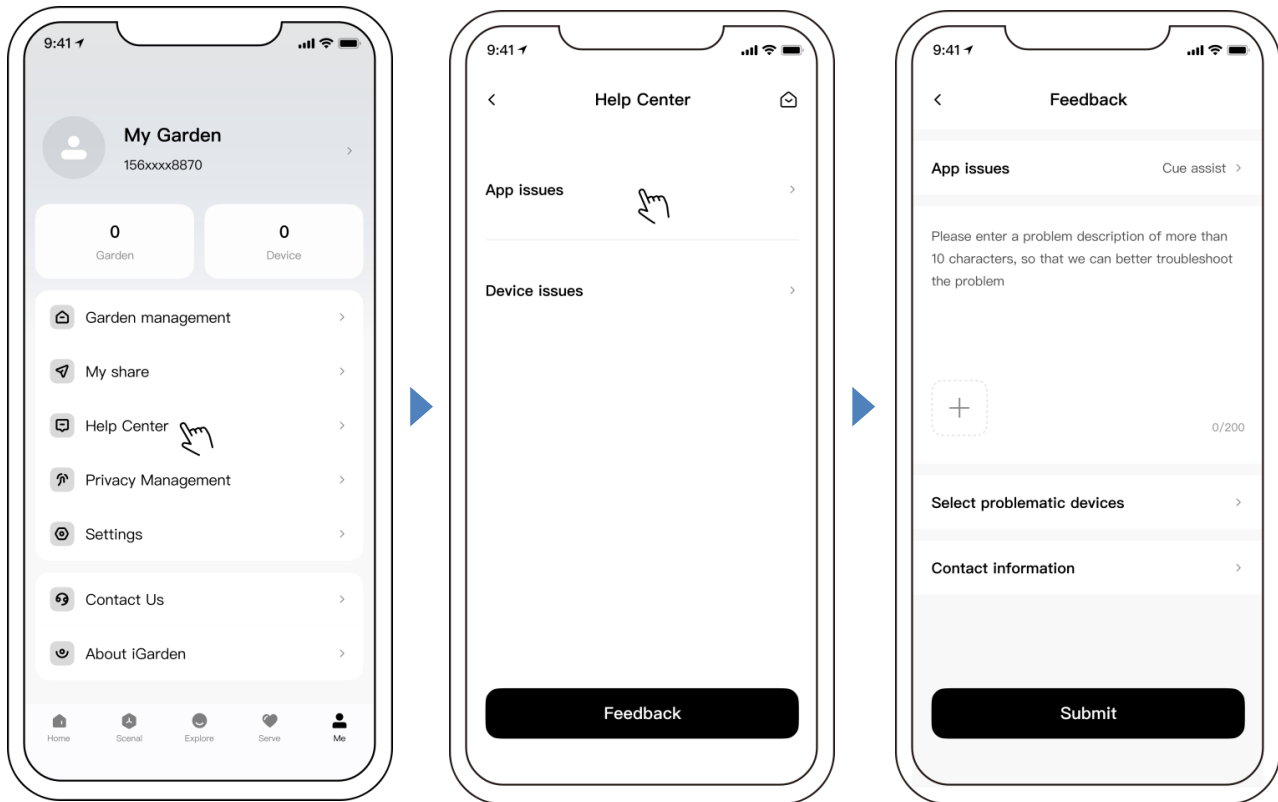

Notice:

- 1) The weather forecast is just for reference.
- 2) The power consumption data is for reference only, as it may be affected by network problems and imprecision of the calculation.
- 3) The App is subject to updates without notice.

7. EXTERNAL CONTROL

External control can be enabled via the following contacts. If more than one external control is enabled, the priority is as below: Digital Input > Analog Input > RS485 > Panel control.

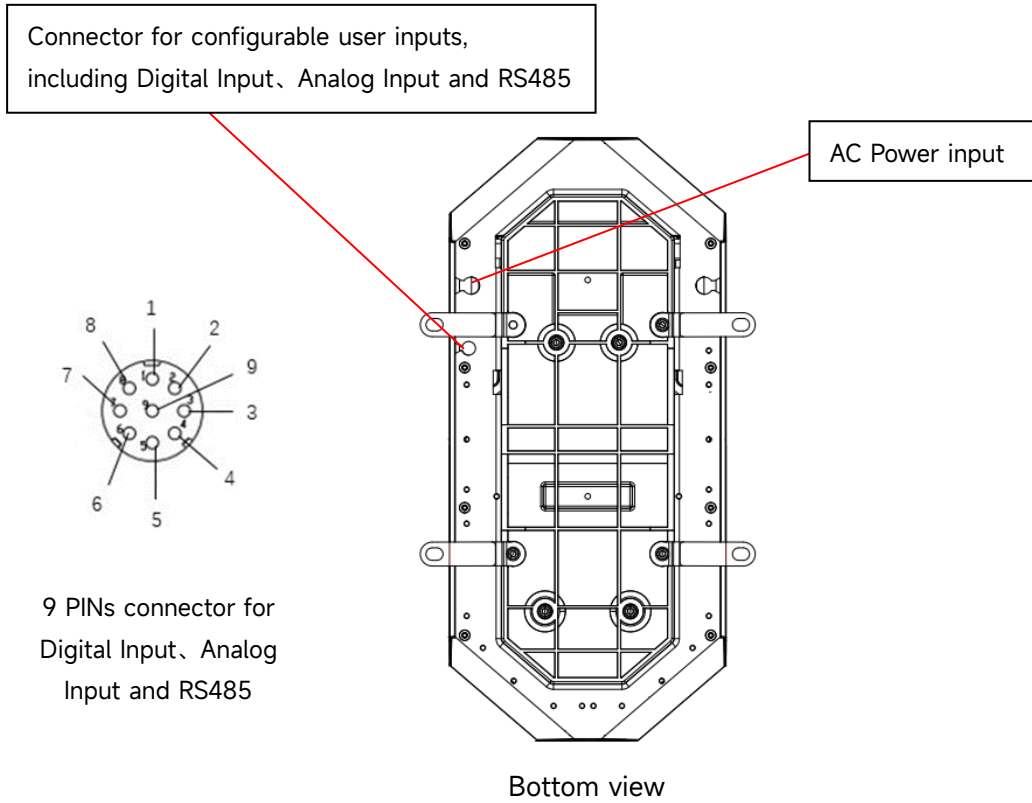

Figure 5 - Connector port location

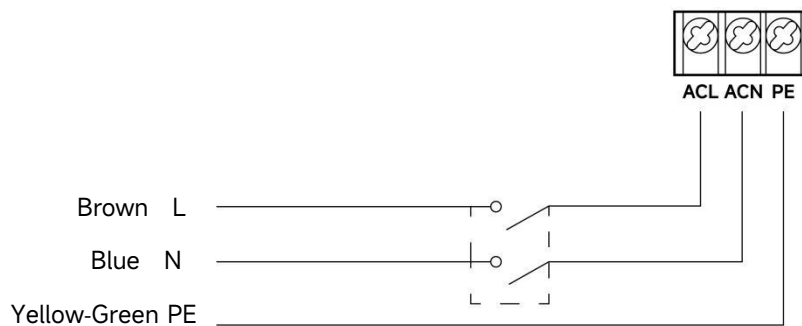

Figure 6 - Power cord connection

External Control	Color	Description	Note
Digital Input	Red	Di4 (Digital Input 4)	Default speed = 40 %
	Black	Di3 (Digital Input 3)	Default speed = 80 %
	White	Di2 (Digital Input 2)	Default speed = 100 %
	Grey	Di1 (Digital Input 1)	Stop
	Yellow	Digital Ground	COM
RS485	Green	RS485-A	/
	Brown	RS485-B	/
Analog Input	Blue	Analog Input (0 ~ 10 V or 0 ~ 20 mA)	/
	Orange	Analog Ground	COM

a. Digital Input

When the parameter setting (address No.5) is set to “3”, the digital input function is enabled. (see 5.11)
The running speed is determined by the state of digital input.

1) When Di1 (Grey) connects with COM (Yellow) , the pump will be mandatory to stop; if disconnected, the digital control will be invalid.

2) When both Di1 (Grey) and Di2 (White) connect with COM (Yellow) , the pump will be mandatory to run at 100%.

2.1) If both Di1 (Grey) and Di2 (White) disconnect with COM (Yellow) at the same time, the control priority will back to the panel control;

2.2) If Only Di2 (White) disconnects with COM (Yellow) , the pump will be mandatory to stop;

3) When both Di1 (Grey) and Di3 (Black) connect with COM (Yellow) , the pump will be mandatory to run at 80%.

3.1) If both Di1 (Grey) and Di3 (Black) disconnect with COM (Yellow) at the same time, the control priority will back to the panel control;

3.2) If Only Di3 (Black) disconnects with COM (Yellow) , the pump will be mandatory to stop;

4) When both Di1 (Grey) and Di4 (Red) connect with COM (Yellow) , the pump will be mandatory to run at 40%.

4.1) If both Di1 (Grey) and Di4 (Red) disconnect with COM (Yellow) at the same time, the control priority will back to the panel control;

4.2) If Only Di4 (Red) disconnects with COM (Yellow) , the pump will be mandatory to stop;

5) If there are a few Di (Grey) connect with COM (Yellow) at the same time, the control priority is Di2 > Di3 > Di4.

b. Analog Input

When the parameter setting (address No.5) is set to “1” or “2”, the analog input function is enabled. (see 5.11)

Setting to “1” means analog current control, setting to “2” means analog voltage control.

To connect Di1 (Grey) and Analog Input (Blue) with COM (Orange) , the running speed could be determined by 0 ~ 10 V analog voltage signal or 0 ~ 20 mA analog current signal.

State	Current control (mA)	Voltage control (V)
Invalid	0 — 2.6	0 — 1.3
Power off	2.6 — 5.8	1.3 — 2.9
30%	5.8 — 6.8	2.9 — 3.4
35%	6.8 — 7.8	3.4 — 3.9
40%	7.8 — 8.7	3.9 — 4.4
45%	8.7 — 9.7	4.4 — 4.9
50%	9.7 — 10.7	4.9 — 5.4
55%	10.7 — 11.7	5.4 — 5.9
60%	11.7 — 12.6	5.9 — 6.4
65%	12.6 — 13.6	6.4 — 6.9
70%	13.6 — 14.6	6.9 — 7.4
75%	14.6 — 15.6	7.4 — 7.9
80%	15.6 — 16.5	7.9 — 8.4
85%	16.5 — 17.5	8.4 — 8.9
90%	17.5 — 18.5	8.9 — 9.4
95%	18.5 — 19.5	9.4 — 9.8
100%	19.5 — 20.0	9.8 — 10.0

c. RS485

When the parameter setting (address No.5) is set to “4”, the RS485 function is enabled. (see 5.11)

To connect with RS485-A (Green) and RS485-B (Brown), the pump could be controlled via Modbus 485 communication protocol.

8. PROTECTION AND FAILURE

8.1. High-Temperature Warning and Speed Reduction - AL01

In "Auto Inverter/Manual Inverter Mode" and "Timer mode" (except backwash/self-priming), when the module temperature reaches the high-temperature warning trigger threshold (81°C), it enters the high-temperature warning state; when the temperature drops to the high-temperature warning release threshold (78°C), the high-temperature warning state is released. The display area alternately displays AL01 and the running speed or flow.

If AL01 is displayed, the running capacity will be automatically reduced as below:

- 1) If the current operating capacity is higher than 100 %, the running capacity will be automatically reduced to 85 %;
- 2) If the current operating capacity is between 85 and 100 %, the running capacity will be automatically reduced by 15 %;
- 3) If the current operating capacity is between 70 and 85 %, the running capacity will be automatically reduced by 10 %;
- 4) If the current operating capacity is lower than 70 %, the running capacity will be automatically reduced by 5 %.

8.2. Under-voltage protection - AL02

When the device detects an input voltage of less than 198 V, it will limit the current running speed. The display area alternately displays AL02 and the running speed or flow.

- 1) When the input voltage is less than or equal to 180 V, the running capacity will be limited to 70 %.
- 2) When the input voltage range is within 180 – 190 V, the running capacity will be limited to 75 %.
- 3) When the input voltage range is within 190 – 198 V, the running capacity will be limited to 85 %.

8.3. Troubleshooting

Problem	Possible causes and solutions
Pump does not start	<ul style="list-style-type: none">• Power Supply fault, disconnected or defective wiring.• Fuses blown or thermal overload open.• Check the rotation of the motor shaft for free movement and lack of obstruction.• Because of a long time lying idle. Unplug the power supply and manually rotate motor's rear shaft a few times with a screwdriver.

Pump does not prime	<ul style="list-style-type: none"> • Empty pump/strainer housing. Ensure the pump/strainer housing is filled with water and that the O-ring on the cover is clean. • Loose connections on the suction side. • Strainer basket or skimmer basket loaded with debris. • Suction side clogged. • If the distance between the pump inlet and the liquid level is higher than 2m, the installation height of the pump should be lowered.
Low Water Flow	<ul style="list-style-type: none"> • Pump does not prime. • Air entering suction piping. • Basket full of debris. • Inadequate water level in pool.
Pump being noisy	<ul style="list-style-type: none"> • Air leak in suction piping, cavitation caused by restricted or undersized suction line or leak at any joint, low water level in pool, and unrestricted discharge return lines. • Vibration caused by improper installation, etc. • Damaged motor bearing or impeller (need to contact the supplier for repair).

8.4. Error code

When the device detects a failure, it will stop automatically and display the error code. After stopping for 15 seconds, check if the failure is cleared. If cleared, the pump will resume working.

Item	Error Code	Details	
1	E001	Description	Abnormal input voltage: the power supply voltage is out of the range of 165 to 275 V.
		Process	The pump will stop automatically for 15 sec and resume working if it detects the power supply voltage is within the range.
2	E002	Description	Output over current: The peak current of the pump is higher than the protection current.
		Process	The pump will stop automatically for 15 sec and then resume working, if this occurs for three times continuously, the pump will shut down and need to be checked and restarted manually.
3	E101	Description	Heat sink overheat: The heat sink temperature reaches 91 °C for 10 sec.
		Process	The pump will stop automatically for 30 sec and resume working if it detects the heat sink temperature is less than 81°C.
4	E102	Description	Heat sink sensor error: The heat sink sensor detects an open or short circuit.
		Process	The pump will stop automatically for 15 sec and resume working if it detects the heat sink sensor is not open or short circuit.
5	E103	Description	Master driver board error: The Master driver board is faulty.
		Process	The pump will stop automatically for 15 sec and then resume

			working, if this occurs for three times continuously, the pump will shut down and need to be checked and restarted manually.
6	E104	Description	Phase-deficient protection: Motor cables are not plugged into the master drive board.
		Process	The pump will stop automatically for 15 sec and then resume working, if this occurs for three times continuously, the pump will shut down and need to be checked and restarted manually.
7	E105	Description	AC current sampling circuit failure: When the pump power off, the bias voltage of the sampling circuit is out of the range of 2.4 ~ 2.6 V.
		Process	The pump needs to be powered off and restarted manually.
8	E106	Description	DC abnormal voltage: The DC voltage is out of the range of 210 to 420 V.
		Process	The pump will stop automatically for 15 sec and then resume working, if this occurs for three times continuously, the pump will shut down and need to be checked and restarted manually.
9	E107	Description	PFC protection: PFC protection occurs on the Master driver board.
		Process	The pump will stop automatically for 15 sec and then resume working, if this occurs for three times continuously, the pump will shut down and need to be checked and restarted manually.
10	E108	Description	Motor power overload: Motor power exceeds the rated power by 1.2 times
		Process	The pump will stop automatically for 15 sec and then resume working, if this occurs for three times continuously, the pump will shut down and need to be checked and restarted manually.
11	E201	Description	Circuit board error: When the pump power off, the bias voltage of the sampling circuit is out of the range of 2.4 ~ 2.6 V.
		Process	The pump needs to be powered off and restarted manually.
12	E203	Description	RTC time reading error: Reading and writing the information of timer clock is incorrect.
		Process	The pump needs to be powered off and restarted manually.
13	E204	Description	Display Board EEPROM reading failure: Reading and writing the information of display board EEPROM is incorrect.
		Process	The pump needs to be powered off and restarted manually.
14	E205	Description	Communication Error: The communication between the display

			board and the master driver board has failed for 15 seconds.
		Process	The pump will stop automatically for 15 seconds and resume working if it detects that the communication between the display board and the master driver board lasts 1 second.
15	E207	Description	No water protection: The pump is lack of water.
		Process	Stop the pump manually, fill up the pump with water and restart it. If this occurs for twice continuously, the pump will shut down and need to be checked manually.
16	E209	Description	Loss of prime: The pump cannot self-priming due to the reasons such as exceeding the suction range or the pipeline is too complicated.
		Process	Check the pump or pipeline that there is no leakage, and then fill up the pump with water and restart it.

9. MAINTENANCE

Empty the strainer basket frequently. The basket should be inspected through the transparent lid and emptied when there is an evident stack of rubbish inside. The following instructions should be followed:

- 1). Disconnected the power supply.
- 2). Press the cover plate to spring it up and open the cover plate.
- 3). Unscrew the strainer basket lid anti-clockwise and remove.
- 4). Lift up the strainer basket.
- 5). Empty the trapped refuse from the basket and rinse out the debris if necessary.

Note: Do not knock the plastic basket on a hard surface as it will cause damage

- 6). Inspect the basket for signs of damage, and replace it.
- 7). Check the lid O-ring for stretching, tears, cracks or any other damage
- 8) Replace the lid; hand-tightening is sufficient.

Note: Periodic inspection and cleaning of the strainer basket will help prolong its life.

10. WARRANTY & EXCLUSIONS

Should a defect become evident during the warranty term, at its option, the manufacturer will repair or replace the item or part at its own cost and expense. Customers must follow the warranty claim procedure to receive the benefits of this warranty.

The guarantee will be void in cases of improper installation, improper operation, inappropriate use, tampering, or the use of non-original spare parts.

11. DISPOSAL



When disposing of the product, please sort the waste as electrical or electronic product waste and hand it over to your local waste collection system.

The separate collection and recycling of waste equipment at the time of disposal will help ensure that it is recycled in a manner that protects human health and the environment.

Contact your local authority for information on where you can drop off your water pump for recycling.

VAGNER POOL s.r.o.

Nad Safinou 348

252 42 Vestec

Czech Republic

info@vagnerpool.com

www.vagnerpool.com

AG027-IT-01

v250815