

# ASIN AQUA

CLF, REDOX, DOSE

# ASIN AQUA Net

CLF, REDOX, DOSE





# General safety information

This user manual contains basic information that should be observed during assembly, start-up, operation, and maintenance. Therefore, this user manual must be read by installers and operators prior to assembly and start-up, and must be accessible to every user of this unit. Additionally, all further safety information in this document absolutely must be observed. Read and follow all instructions. In order to minimize the danger of injury, do not allow children to use this product. Hazards from non-compliance with safety information. Non-compliance with safety information can result in hazards to persons, the environment, and the equipment. Non-compliance with safety information will result in a forfeit of any potential right to damage compensation.

## Insufficient personnel qualification

Hazards in the event of insufficiently qualified personnel,  
potential consequence: Injury, heavy material damage.

- The system operator must ensure compliance with the required qualification level.
- Any and all work may only be performed by correspondingly qualified personnel.
- Access to the system must be prevented for insufficiently qualified persons, e.g. via access codes and passwords.

## Potential overdosing of chemical agents

Despite ASIN Aqua® comprehensive safety functions, it is possible that a probe failure and other errors could lead to an overdosing of chemical agents. Potential consequence: Injury, heavy material damage.

- Design your installation such that uncontrolled dosage is not possible in the event of a probe failure or other errors, and/or such that uncontrolled dosage is recognized and halted before damage is incurred.
- Uncontrolled overdose of chemicals can cause harm to health and property. Even though the device contains a number of security elements can not be ruled out that in case of failure of the measuring probes, or the whole device may result in overdose of chemical agents. Install the equipment so that uncontrolled overdose of chemicals was not possible and that uncontrolled overdose has been detected in time before causing any harm. It is necessary to use chemicals in such quantities that an overdose will not cause dangerous concentration of chemical agents. Do not use chemicals in too large packages or with too high concentration.

## Gaseous chlorine produced from dosing in standing water if dosing outputs are not closed via the filter pump

If the flow switch is stuck or experiences another error, there is a risk of dosing into standing water. Poisonous chlorine gas can be yielded when sodium hypochlorite and pH minus come together.

## Non compliance with informational text

There is a great deal of informational text indicating hazards and their avoidance. Not observing informational text may lead to hazards. Potential consequence: gravest degree of injury, heavy material damage.

- Read all informational text carefully.
- Cancel the process if you are unable to exclude all potential hazards.

## Use of new functions

Because of the continued development, a ASIN Aqua® unit may contain functions, which are not completely described in this version of the user manual. The use of such new or extended functions without a profound and secure understanding by the operator may result in malfunctions and severe problems. Potential consequence: Injury, heavy material damage.

- Make sure to get a profound and secure understanding of a function and relevant boundary conditions, before you start to use it.
- Check for an updated version of the user manual or additional documentation available for the relevant functions.
- Make use of the integrated help function of the ASIN Aqua® to get detailed information on functions and their parameter settings.
- In case it should not be possible to get a profound and secure understanding of a function based on the available documentation, do not use this function.

## Overdosing if pH value is wrong

If disinfection is enabled before the pH value is stable in the ideal range of 7.0 to 7.4, then it may lead to heavy overdosing of chlorine or bromine. Potential consequence: Injury, heavy material damage.

- Do not start disinfection with chlorine until the pH value is stable in the ideal range between 7.0 and 7.4.

## Conditions before using

Make sure you have a newest and updated version of the user manual and other documentation for all functions of the unit. Use and read the integrated help features. In case of not understanding the information about certain features of the unit, do not use these features.

## Handling chemicals for pool water treatment

The chemicals used with the ASIN Aqua must be handled in a safe manner to prevent damage or personal harm. Aseko recommends you always use personal protective safety equipment when handling the pH and chlorine agents. Refer to the Materials Safety Data Sheet (MSDS).

**WARNING:** Never mix the pH agent with the chlorine agent. When carrying out maintenance on the clear plastic tubes or valves always rinse with clean water to prevent mixing of the pH and chlorine agents.



# What's in the box

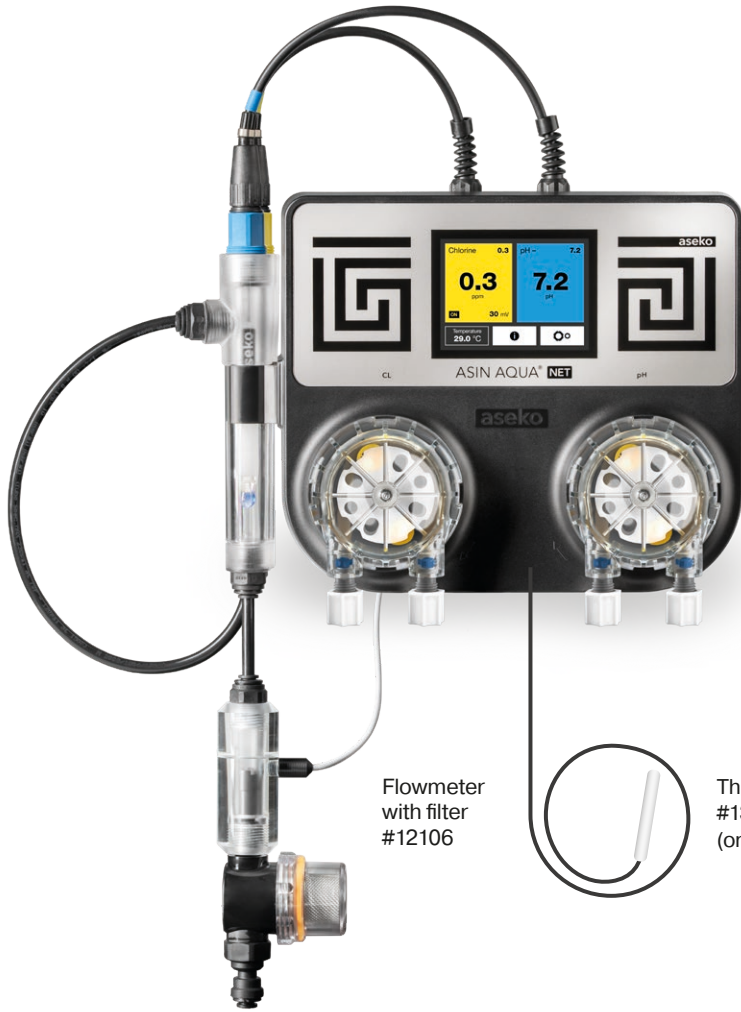

ASIN AQUA  
or  
ASIN AQUA Net

Peristaltická  
čerpadla  
#12093

Flowmeter  
with filter  
#12106

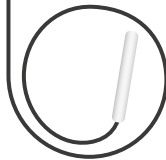

Thermometer  
#13192  
(only for ASIN AQUA Net)

pH probe Long Life  
# 12012



CLF probe  
#12052



or

Redox probe Long Life  
# 12016



Water valves 2 pcs  
#12006



Injection valve 2 pcs  
#12005



Suction tube weight 2 pcs  
#12023



Thermometer holder 1 pcs  
#12044  
(only for ASIN AQUA Net)



PE Tube 1/4" (6.35 mm)  
transparent  
#12008



Wrench socket for probes  
#13046



Dowels and screws  
#12125



## Available optional accessories

External touch screen  
(only for ASIN AQUA Net)  
#12048



Inserting DN50 plug 1/4" threaded  
for easy installation  
#12134



pH 7.00 Buffer #12065  
Redox Buffer #12063



Pool Lab Photometer  
for accurate calibration #13076



## ASEKO original chemical solution

### Volume 20l

CHLOR PURE #12075



pH MINUS #12130



### Volume 5l

CHLOR PURE #12059



pH MINUS #12131





# ASIN AQUA



ASIN AQUA CLF

# 12001

ASIN AQUA Redox

# 12144

ASIN AQUA Dose

# 12022

ASIN AQUA **Net** CLF

# 12036

ASIN AQUA **Net** Redox

# 12035

ASIN AQUA **Net** Dose

# 12034

# ASIN AQUA

ASEKO's ASIN AQUA gives you pool clean and sparkling water with the minimum amount of chemicals. By directly measuring and controlling the free chlorine content or redox potential of your pool water with advanced CLF (free chlorine) or redox probe. ASIN AQUA tunes your pool water using the minimum amount of chlorine, eliminating the smell and burning of overtreated pools. With a touch screen interface, you have complete control over measurement and regulation of your pool.

## Pool water treatment

### Chlorine control and dosing

Highly effective disinfection treatment of pool water for public and private pools. Extraordinary precise measuring of chlorine content in the pool water by ASEKO CLF - free chlorine probe combined with the system digital intelligence is able to control the preset disinfection level by usage of minimum necessary chemical aids.



### pH control and dosing

ASIN AQUA Net is adjustable to dose pH MINUS or pH PLUS. Treatment for stabilizing of pool water acidity at the optimum level. Precise measuring by pH probe combined with the system digital intelligence controls the preset pH level of the circulating pool water in all pool operation modes and variable environment conditions.



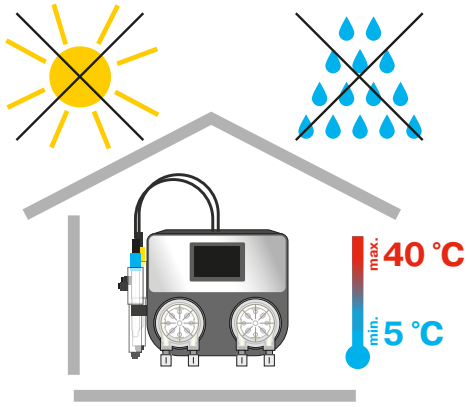

## ASIN AQUA installation

ASIN AQUA is to be wall mounted in dry and dust-free environment with temperature ranging from +5 °C to +40 °C. The location must be selected so that there is at least 30 cm of free space on all sides and a height above the floor was max. 150 cm. Use the screws supplied with ASIN AQUA for fastening.

### WARNING

The temperature at the installation site should be permanently between **+5 ° and + 40 ° C**. Humidity max **70% RH**.

Direct sunlight, high humidity and dust can lead to damage ASIN AQUA.

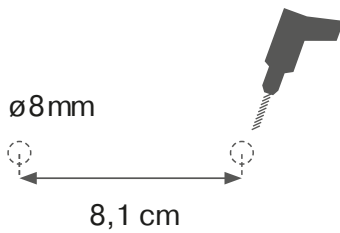
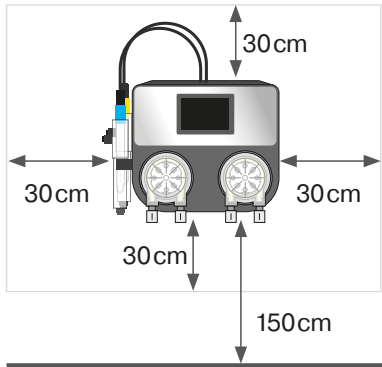

### SWIMMING POOL WATER

ASIN AQUA must be installed on **fresh water** treated by **INORGANIC** superchlorination agent (**SUPERCHLOR # 13120**).

**Do not use organic chlorine!**

Ensure that the water in the pool **DOES NOT CONTAIN STABILIZERS (CYANURIC ACID)** and other impurities!

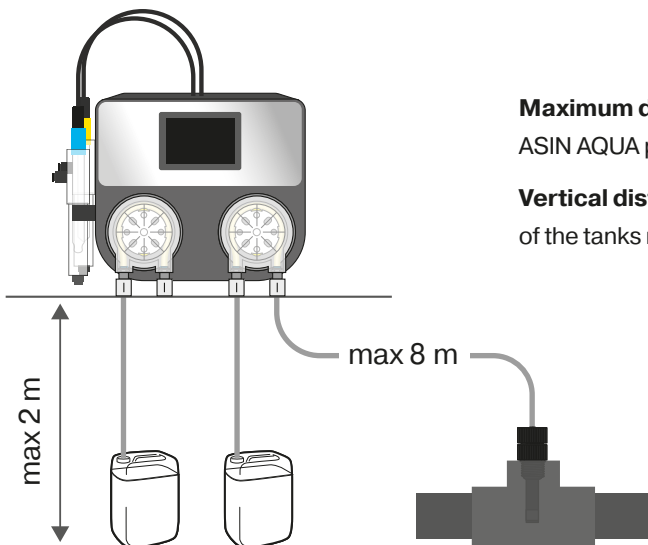

**Maximum distance of injection valves** from peristaltic ASIN AQUA pumps must not exceed **8 m**.

**Vertical distance between ASIN AQUA** and the bottom of the tanks must not exceed a distance of **2 m**.



# Probe installation

Probe wrench



- 1 Carefully insert the **CLF or Redox probe** into the well on the left. Tighten by hand or with the included plastic probe wrench. Connect the connector (marked in yellow)
- 2 Carefully insert the **pH probe** into the well on the right. Tighten by hand or with the included plastic probe wrench. Connect the connector (marked in blue).

## WARNING

Tighten the probes only by hand or with the enclosed plastic wrench.  
Do not use pliers or other tools!

CLF probe  
# 12052



Redox probe  
Long Life  
#12016

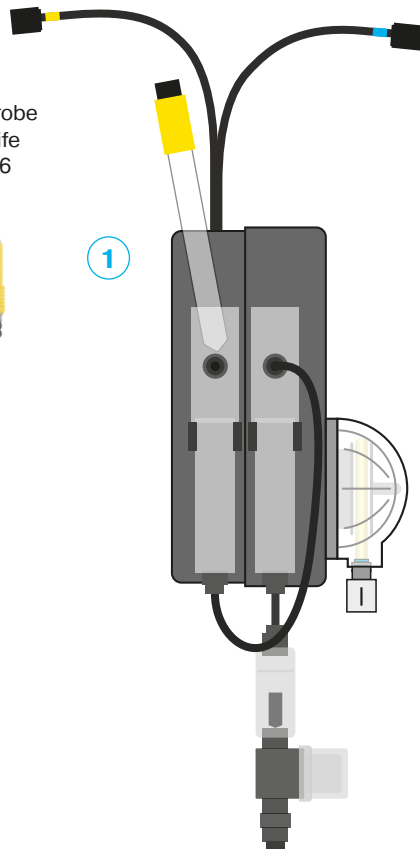

pH probe  
Long Life  
#12012

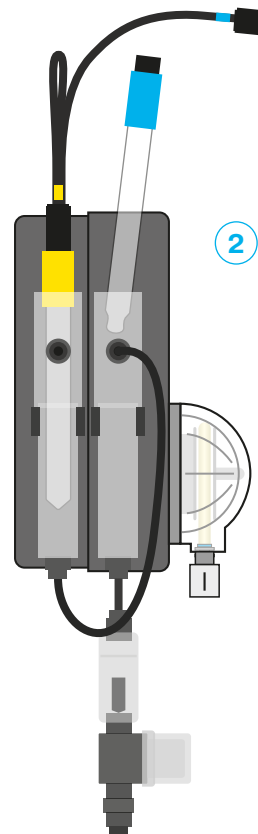

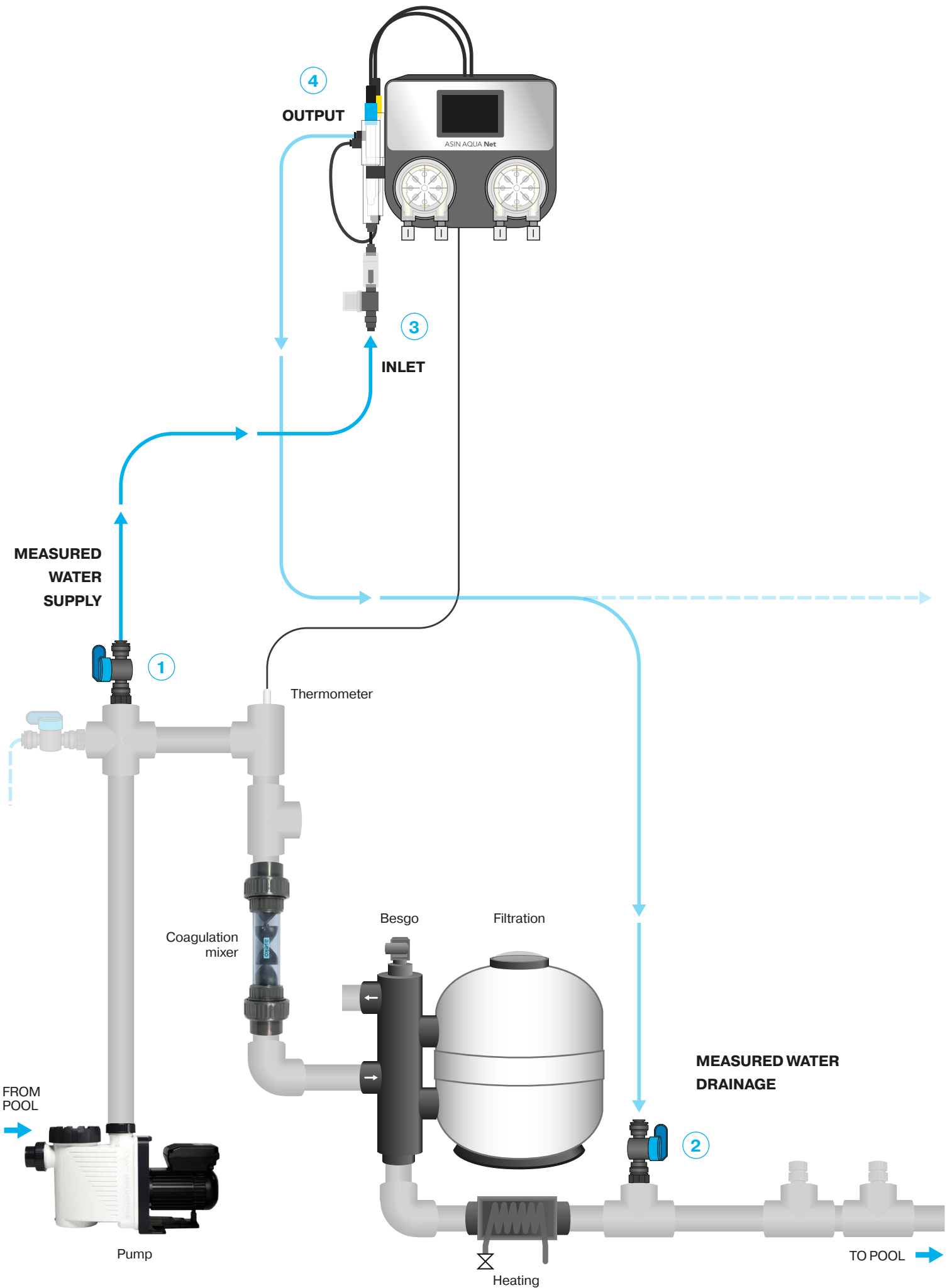

# Pool Water Connection

The pool water to be measured must be brought to the ASIN AQUA probes.

We place the **shut-off valve** in the plug D = 50 with thread G1 / 4 "# 12134, glued to the T-piece. **Tighten by hand only. Do not use pliers or other tools.**

- 1 Connect the **MEASURED WATER SUPPLY** to the pipe **behind the pump, in front of the filter** and the coagulation mixer.
- 2 Connect the **MEASURED WATER DRAINAGE** to the pipe **behind the filter** and heating or into the overflow tank or skimmer.

Use to connect the measured water to your ASIN AQUA PE tube 1/4 "(6.35 mm) #12008, which is part of the delivery.

## WARNING

To ensure that the joints are tight, cut the PE tube at an angle of 90°. Use special pliers # 13325 to cut plastic tubes. The cut must be clean and smooth. Do not use ordinary scissors or knives!

The measured water is easily connected to your ASIN AQUA using the **Speedfit** push-in fitting.

**CONNECTION** Push the connecting pipe into the Speedfit fitting and then pull on the hose to secure.

**DISCONNECT** push and hold the Speedfit round collet and pull out the connecting pipe.

- 3 **INLET** of the measured water to the ASIN AQUA Connect to the Speedfit fitting on the inlet filter.
- 4 **OUTPUT** of the measured water from ASIN AQUA connect to the Speedfit fitting on the probe well.

Once connected, your ASIN AQUA is ready to measure disinfectant content and pH value in your pool.

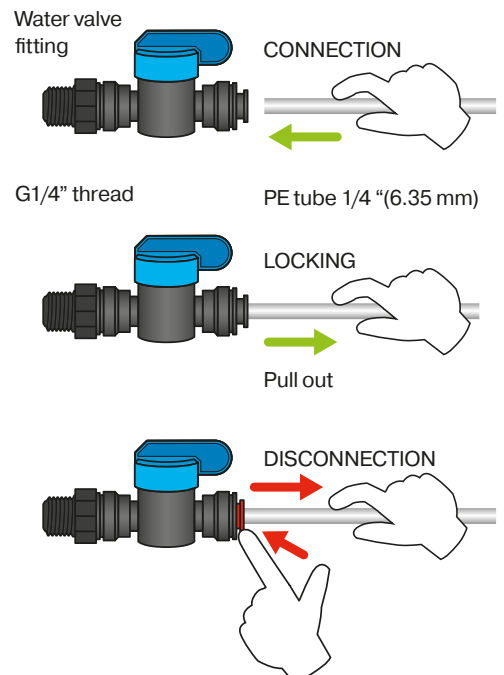
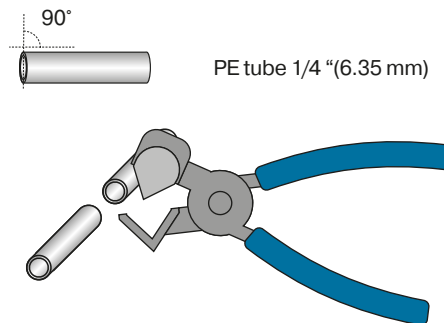
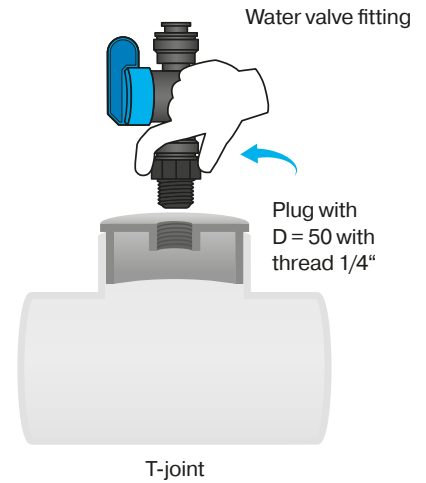



# Pool Chemicals Connection

Screw the **injection valves** into the plug D = 50 with thread G1 / 4 " # 12134, glued to the T-piece. **Tighten by hand only. Do not use pliers or other tools.**

- 1 Connect the **pH INJECTION VALVE** to the piping behind the filter and behind drainage of the measured water.
- 2 Connect the **CHLOR PURE INJECTION VALVE** behind the INJECTION VALVE, this prevents scale formation.  
to connect reagents to ASIN AQUA use PE pipe 1/4 " (6.35 mm) # 12008, which is part of the delivery.

## WARNING

To ensure that the joints are tight, cut the PE tube at an angle of 90°. Use special pliers # 13325 to cut plastic tubes. The cut must be clean and smooth. Do not use ordinary scissors or knives!

- 3 **CANISTER CONNECTION** Drill 6.35 mm and 1 mm diameter holes in the canister cap. Pass the pipe through the cap so that it reaches to the bottom of the canister. Place the suction basket at the end of the pipe.
- 4 **PUMP CONNECTION** connect the suction of the pump on the left to the canister connect the pump discharge on the right to the injection valve.
- 5 **INJECTION VALVE CONNECTION** Pass the pipe through the nut, thread the pipe onto the injection valve and tighten the nut firmly by hand.

## WARNING

**NEVER CONNECT pH minus reagent to disinfection pump or disinfectant to pH pump!** In the case of a cross-connection, after ten doses ASIN AQUA displays an error message. Repair the piping installation and then you can continue to operate your ASIN AQUA.

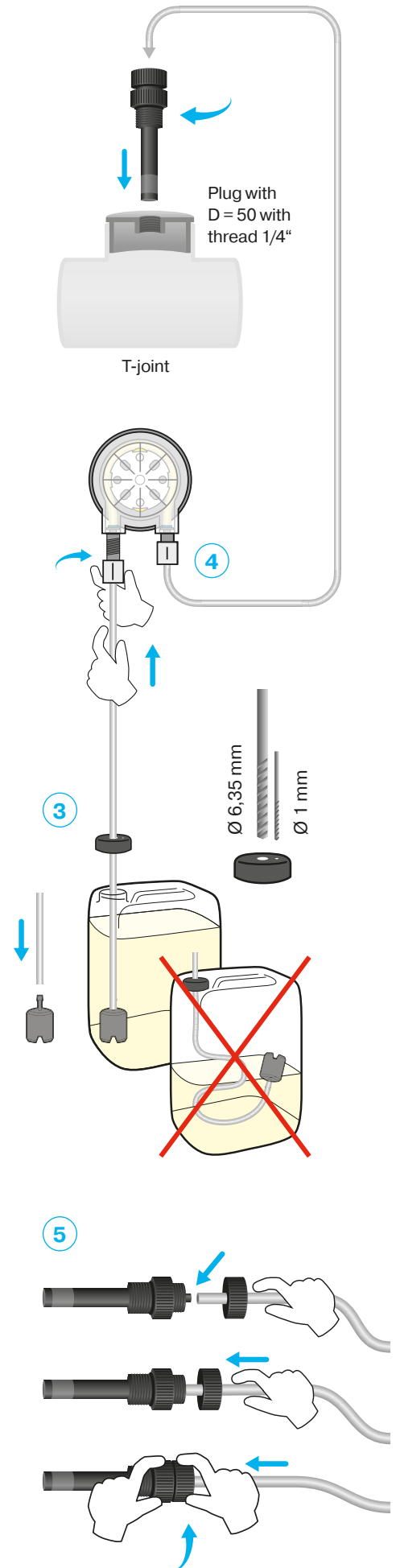



## Power Supply

### Connection to the mains:

Connect the 230 V / 50 Hz main cable to ASIN AQUA .

**The mains socket outlet must be protected by a residual current device (RCD).**

After device has been switched on, the display will come on and the ASIN AQUA Net starting screen will appear.

### Disconnection from the mains:

Disconnect the ASIN AQUA Net mains cable from the 230 V / 50 Hz socket outlet.

### WARNING

If device is used in the manner different from that specified by the manufacturer, protection provided by device may get damaged.

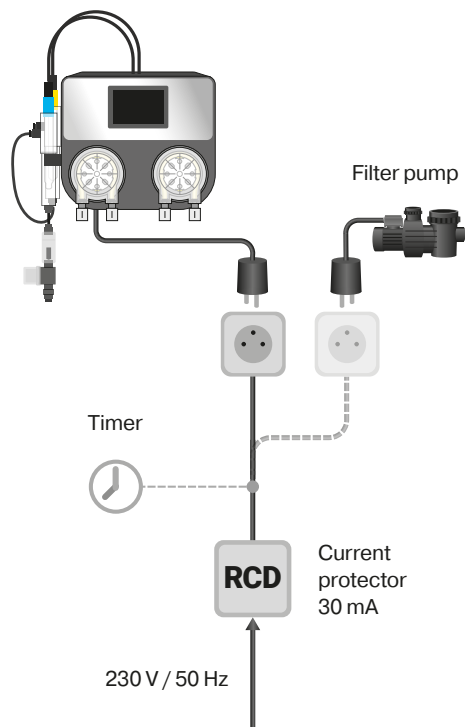



# Installation Test

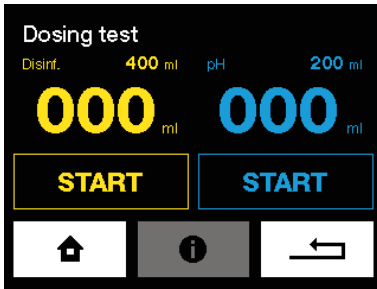

Before commencing the operation, test ASIN AQUA installation. Most problems result from incorrectly performed installation.

## Test

In the “Test of Outputs” menu, gradually start all the pumps and while they are running, check tightness of all the PE tube connections. Check the injecting valves for blockage and air bubbles in the PE tube.

### WARNING

**Any obstacles, bubbles or leaks in the connecting tube will prevent ASIN AQUA Net from correct operating.** The clear plastic tube allows you to monitor flow of liquid to the injecting valves.

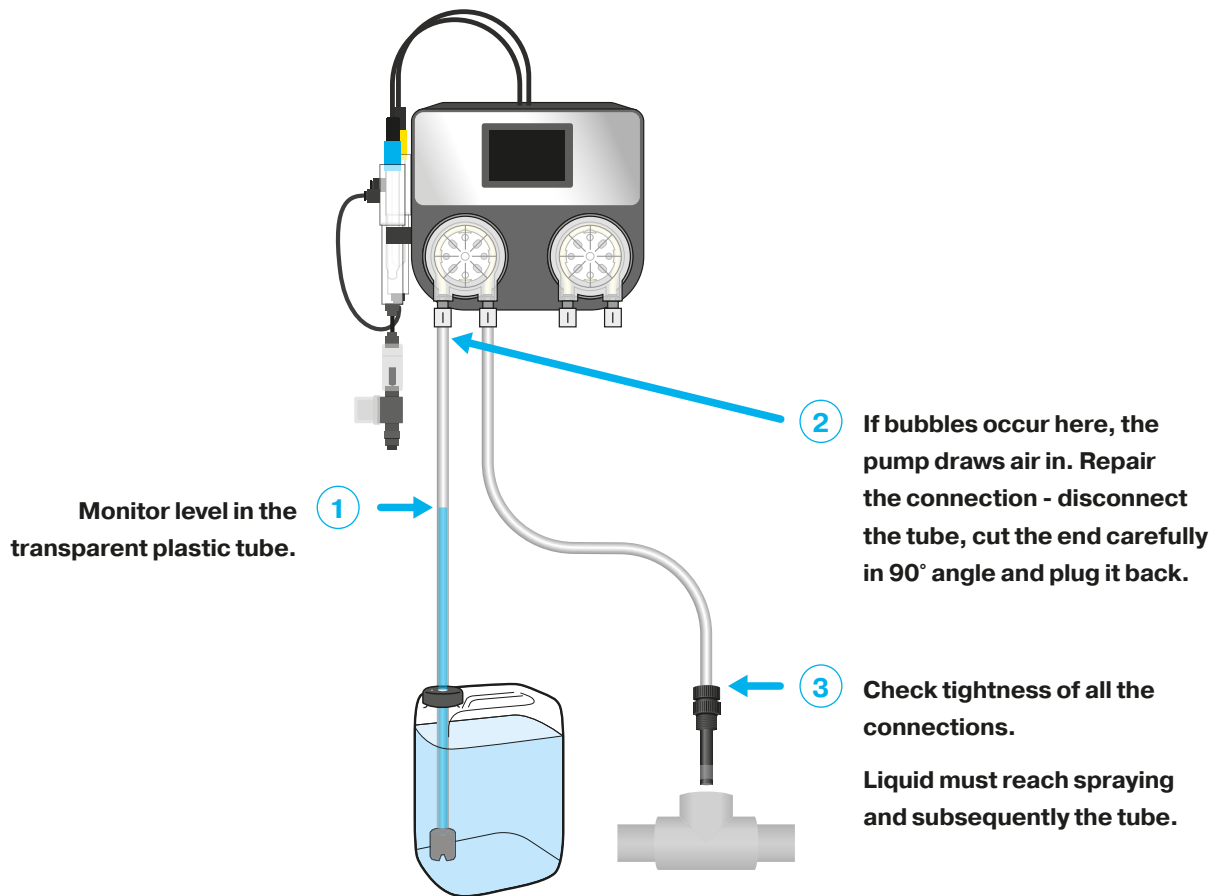

# Control principles

## Home screen

The home screen displays measured, required values and status information.

E.g. click on the **Chlorine** tab to enter the setting of the required chlorine value in pool water.

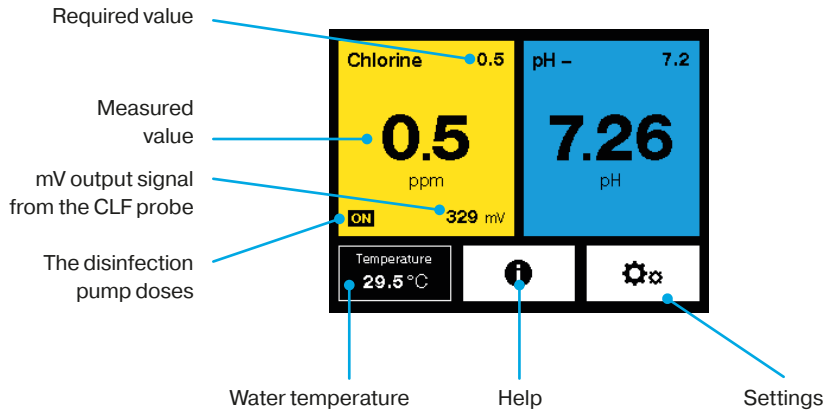

## Settings

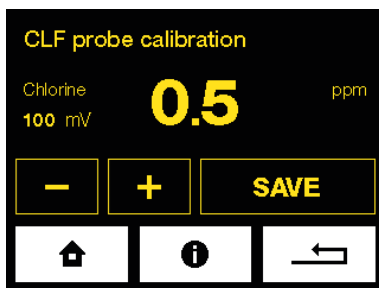
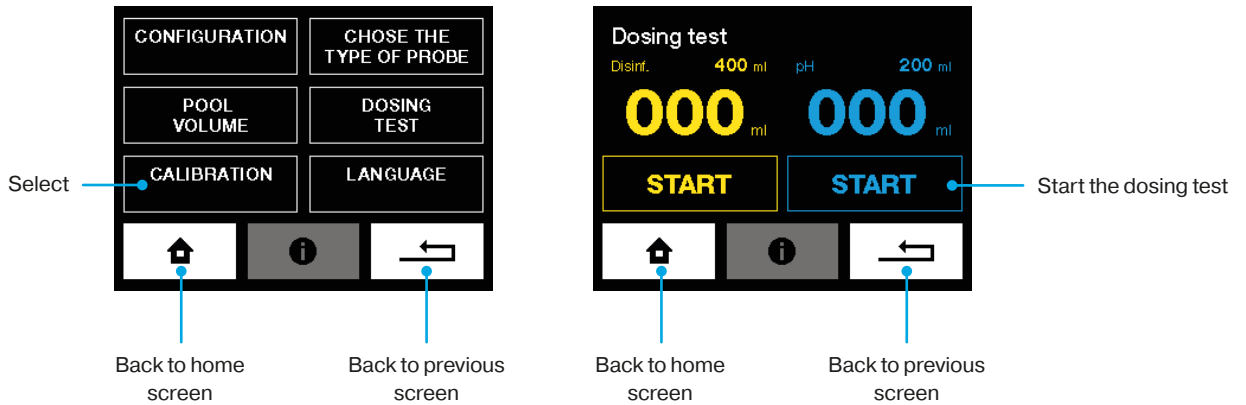

Decrease value



Increase value



# Settings

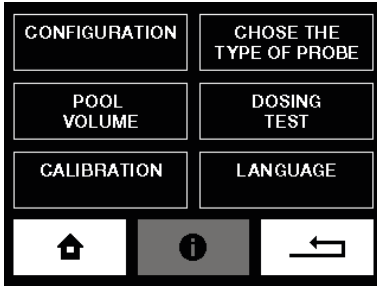

**Configuration** - pool volume, pool type, water hardness

**Pool volume** - set pool volume

**Calibration** - pH probe, CLF probe, thermometer

**Chose the type of probe** - Chose the type of disinfection probe

**Dosing test** - test pump and manual dosing

**Language** - Set the language of the ASIN AQUA Net

## Setting pool parameters

Each pool is unique. Temperature, size, location, and hardness of water all affect how ASIN AQUA monitors and tunes your pool water. For optimum performance, you must set your pool properties in ASIN AQUA.

### Pool volume

To ensure the correct function of ASIN AQUA Net, enter the correct volume of your. Calculate your pool volume in m<sup>3</sup>: Length (L) times width (W) times depth (D) is volume (V) - (L × W × D = V). Enter the value using + and - buttons.

#### **WARNING**

**The pool volume has effect on the maximum safe dose, enter the correct value!**

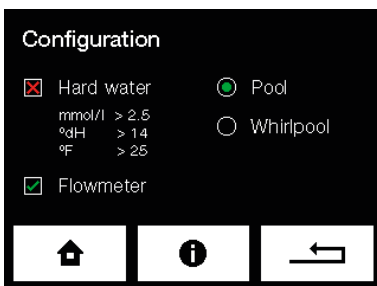

### Pool type

Choose a type of your pool.

#### Hard water

Set the pool water hardness in dH, 0-9 is soft, 9-21 is hard and 21+ is very hard.

#### Flowmeter

The flowmeter detects flow of measured water. Dosing of chemicals will take action only if flow of measured water to probes is detected.

Wash the check flowmeter strainer on a regular basis.

#### **WARNING**

**Only switch off the flowmeter in case of a failure!**

# Choosing the disinfection probe

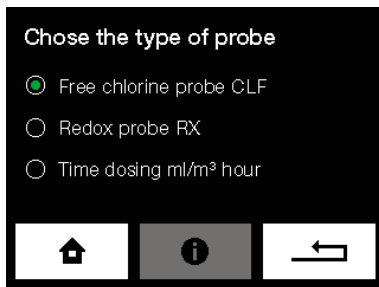

## 1. CLF free chlorine probe

Free chlorine measurement, CHLOR PURE dosing



## 2. Redox probe of the RX potential

Measurement of redox potential, CHLOR PURE dosing



## DOSE ml/m³ time dose per hour

Without a probe

# Setting Values

## Commissioning procedure

### SWIMMING POOL WATER

ASIN AQUA must be installed on **fresh water** treated by **INORGANIC** superchlorination agent (**SUPERCHLOR # 13120**).

**Do not use organic chlorine!**

Ensure that the water in the pool **DOES NOT CONTAIN STABILIZERS (CYANURIC ACID)** and other impurities!

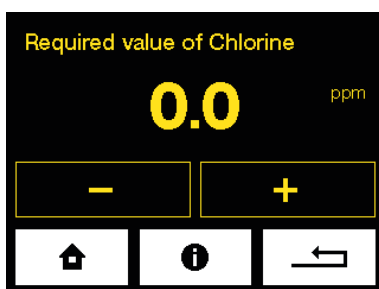

## 1. Ensure the filtration system runs **NONSTOP** for 24 hours

- Set the required values via the main screen by pressing the appropriate tab (see the chapter Control):
- If you have the CLF probe, set the disinfection to 0.0 mg/l. If you have the REDOX probe, set the disinfection to 000 mV.
- pH values leave at the factory setting for the time being (pH 7.0).

## 2. Close the water supply to the probes

ASIN AQUA Net displays „No water supply to the probes“ notification.

## 3. Perform superchlorination

Perform superchlorination of pool water with Super CHLOR (inorganic active chlorine without stabilizers). Follow the instructions on the packaging (1 kg = 80 m³).

#### 4. Wait at least 1 hour. Optimally up to 24 hours.

**Before opening the water supply** to the probes, the water must be **clean** and the **chlorine concentration** measured by the colorimeter or Pool Tester must be within the range **0.3 to 1.2 mg/l**.

If the **concentration is lower**, repeat superchlorination. If the **concentration is higher**, wait till the chlorine concentration in the water drops down.

#### 5. Open the water supply to the probes

The „No water supply to the probes“ notification will disappear from the ASIN AQUA display.

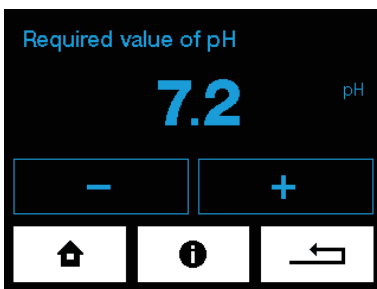

#### 6. pH adjustment

- Set the required pH value ideally close to the pH value of the incoming water.
- ASIN AQUA Net adjusts the pH automatically according to the preset required value.
- The ideal pH value should be between 6.8 and 7.5.

#### 7. Depending on the type of a probe you have, proceed according to the chapter:

- If you have the CLF probe
- If you have the REDOX probe

# If you use the CLF probe

For the correct functionality of the CLF probe you must observe the following conditions:

## pH of the pool water

The ideal pH value should be between **6.8 and 7.5**.

**The pH of the pool water must be stabilized.**

If the pH value fluctuates, the value of the chlorine in pool water changes accordingly.

Chlorine Level mg/l	Water Temperature
0,3 – 0,5	24 – 26 °C
0,5 – 0,8	26 – 32 °C
0,8 - 1	higher than 32 °C

## Determination of the required chlorine value in pool water

The required concentration of chlorine in pool water varies with the temperature of the pool water. However, it should never be less than 0.3 mg/l. Determine the required value using the table located on the left.

## How to set the required chlorine value

Use a colorimeter or Pool Tester to measure the chlorine value in pool water sample.

If the chlorine concentration (measured with a colorimeter or Pool Tester) is:

- **ADEQUATE** to the value shown on the ASIN AQUA Net display, your device is ready to maintain the required concentration of chlorine in pool water.
- **BELOW** the required value shown on the ASIN AQUA Net display, **increase** the required value over the current setting by 0.1 (by 0.2 mg/l max) (regardless of the required value according to the table).

Repeat the measurement after the water in the pool is mixed thoroughly and the required value shown on the ASIN AQUA Net display is settled. Repeat the process until the **chlorine concentration in pool water matches the required value** then set the correct required value according to the table. Subsequently you can calibrate the CLF probe (see the chapter CLF Probe Calibration).

- **HIGHER** than the required value shown on the ASIN AQUA Net display - you can calibrate the CLF probe (see the chapter CLF Probe Calibration).

### NOTIFICATION:

Fix the low chlorine value in pool water by **increasing required disinfection value**.

### RECOMMENDATION:

Check the chlorine content in the pool once a week using the colorimeter or tester.

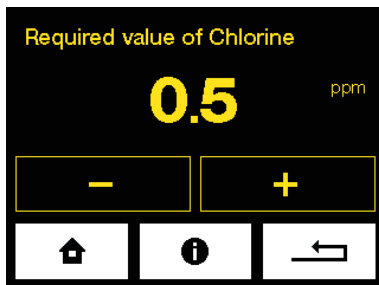



# If you use the Redox probe

For the correct functionality of the REDOX probe, you must observe the following conditions:

## pH of the pool water

The ideal pH value should be between **6.8 and 7.5**.

**The pH of the pool water must be stabilized.**

If the pH value fluctuates, the value of the Redox changes accordingly.

## Determination of the required chlorine value in pool water

The required concentration of chlorine in pool water varies with the temperature of the pool water. However, it should never be less than 0.3 mg/l. Determine the required value using the table located on the left.

Chlorine Level mg/l	Water Temperature
0,3 – 0,5	24 – 26 °C
0,5 – 0,8	26 – 32 °C
0,8 - 1	higher than 32 °C

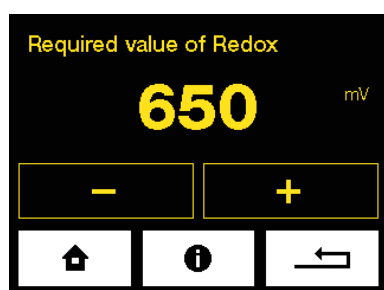

## How to set the required Redox value

Set the required REDOX value to **650 mV**.

Use the tester to check if the **chlorine content in pool water is within the range of 0.5 - 1.2 mg/l**.

## Wait for 24 hours to let the probe stabilize.

## Fine-tuning

Use the colorimeter or Pool Tester to measure the chlorine value of the pool water sample.

- If the chlorine value in pool water is **ADEQUATE**, your ASIN AQUA Net is prepared to maintain the required concentration of chlorine in pool water.
- If the chlorine value in pool water is **LOW**, increase the required REDOX mV value in the menu.
- If the chlorine value in pool water is **HIGH**, reduce the REDOX mV value in the menu.

**Every 10 mV corresponds approximately to 0.1 mg/l of chlorine in the pool water.**

### EXAMPLE:

The chlorine value in the pool water is 0.3 mg/l - the displayed value is 650 mV. If you want to increase the chlorine value to 0.5 mg/l. You have to increase the preset value of the redox by 20 mV to 670 mV.

### NOTE:

The relationship of Redox potential and chlorine content in pool water cannot be determined by the exact table. The correct value of the Redox must be observed by several check measurements.

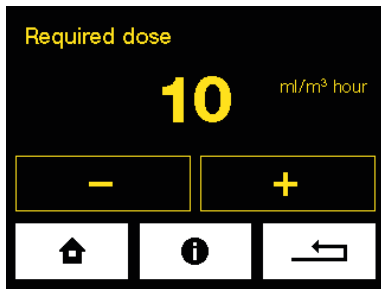

## If you use time dosing without probe

Your ASIN AQUA Net is already installed, connected to pool water and to chemical agents.

- Set up the sanitation dosing volume on 5 ml/m<sup>3</sup> per hour if you use the chlorine sanitation agent.
- Set up the pH value to 6,8

### Fine tune

- Manually check the chlorine or active oxygen level in the pool water.
- Then increase or decrease the setup “dosing volume”.

**Do not calibrate the pH probe with a pH difference of less than 1.**

**The pH probe can be calibrated in the pH range 6.2 to 7.8.**

**The pH probe cannot be calibrated when the LOW or HIGH warning is displayed.**

## In Operation Measurement and Calibration

### pH Probe Calibration

When pH is being measured in operation, there may be a difference between the ASIN AQUA Net value and the current pH value measured directly in water.

Calibration can be done in two ways:

#### 1. With a buffer

- **Close the water supply to the probes.**
- Remove the probe from ASIN AQUA Net rinse the probe with clean water and wipe it.
- The probe must remain connected to the device via the cable. Immerse the probe in the 7.0 calibration buffer and after stabilization, enter this value into ASIN AQUA Net on the pH Probe Calibration screen.

#### 2. With a colorimeter or Pool Tester

- The water supply to the probes must be open
- Measure the pH value directly in pool water using a colorimeter or Pool Tester.
- Then enter this value into ASIN AQUA Net on the pH Probe Calibration screen. Calibration can be performed in the range of 6.4-7.8

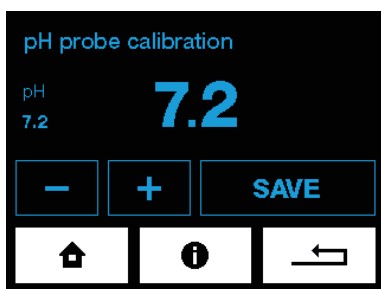

## CLF Probe calibration

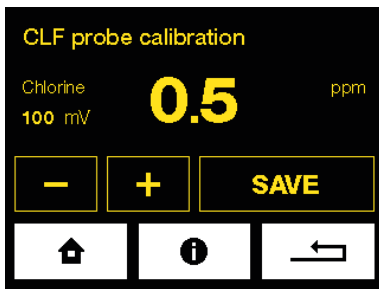

Photometer  
Pool Lab  
# 13076

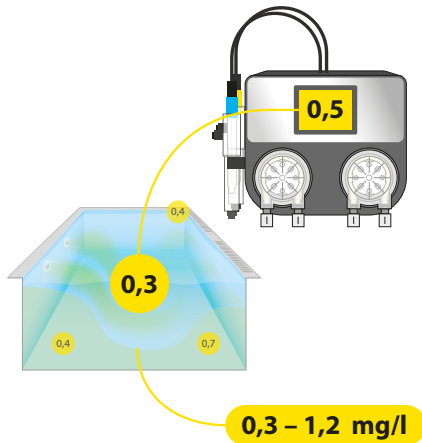

**Do not calibrate the probe until** the water in the pool is thoroughly mixed and **the value on the ASIN AQUA Net display is stable.**

**This may take several hours.**

Calibration is performed by entering the manually measured value of chlorine concentration (using a photometer) in the CALIBRATION menu.

Calibration **is not necessary** if the difference between the photometer measured value and the value shown on the display **is less than 0.2 mg / liter.**

Calibration is best performed with chlorine concentrations in the pool water in the range of **0.3 - 1.2 mg / l.**

**It is best to calibrate to a value equal to or greater than the desired value.**

### Calibration restrictions

The CLF probe cannot be calibrated if the output **signal is less than 20 mV.**

The CLF probe can only be calibrated in the CL range **from 0.3 to 5.0 mg / l.**

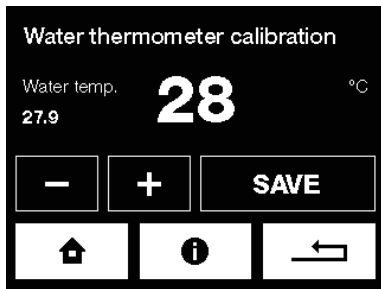

## Water thermometer calibration

If water temperature is different from temperature shown by ASIN AQUA Home, calibrate the thermometer in the water thermometer calibration menu.

## Probe testing

### Testing the pH probe

pH - Buffer 7,00 #12065



If the probe meet following qualifications, it can be used in the system and it is functional:

Probe has no visible mechanical damage.

Measured pH value is in tolerance +/- 1,0 (example - water pH is 7,2 and probe is measuring 7,9 - the tolerance is 0,7 so lower than 1,0 - the probe is OK)

Probe response to positive or negative changes in water or buffer.

**Example:** if you dive the probe with dry and clean tip to 7,0 pH buffer the 1 minute response must be at least 90%

### Testing the REDOX probe

Redox Buffer 475 mV #12063



If the probe meet following qualifications, it can be used in the system and it is functional:

Probe has no visible mechanical damage.

The redox probe naturally ages so its sensitivity but it should never exceed the limit tolerance -12% At the buffer test 475 mV it should not measure less than 420 mV.

Probe response to positive or negative changes in the water free chlorine concentration.

**There is no manufacturer of pH and REDOX probes that cover its products with warranty. ASEKO has decided to cover supplied probes to its clients by two year warranty period that covers free repair of supplied probe that will have higher tolerance than above described.**

### CLF probe test

The Aseko free chlorine probe should have an output signal of at least 20 mV at chlorine concentration 0.8 mg / liter. If the signal is lower, the probe must be sent for inspection. If the probe has a sufficient signal, it is good to perform a test with clean water (the water must be allowed to stand for 24 hours). In pure non-chlorinated water, the signal must be less than 20 mV. Otherwise, the probe must be sent for inspection.

# ASIN AQUA maintenance

To ensure the optimum efficiency, perform visual checks and maintenance of ASIN AQUA Net on a regular basis.

## Pump Hose Replacement

To prevent the pump from failing, it is recommended to replace the hose #12073 every 24 months.

**In doing so, proceed as follows:**

- Switch off ASIN AQUA Net.
- Turn the pump cover cassette counterclockwise and take it out of ASIN AQUA.
- Release both hose ends and take it out of the cassette.
- Lubricate the new hose with the supplied special grease.
- Insert the lubricated hose into the cassette.
- Place the cover cassette back on ASIN AQUA Net and turn it clockwise to lock it.
- Use new nuts, which are part of the replacement hose set, for connection of the PE tube.

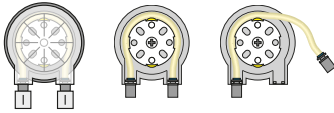
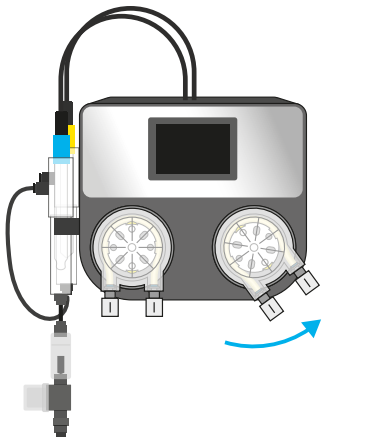

#12073 Replacement tube kit for PP 60



#12005 Injection valve



#13087 Injection valve replacement flap



## Injection Valve Maintenance

On a regular basis, check throughput of the injection valves, rubber band integrity, remove scale.

In case of private pools, replace injection valve rubber bands every 2 years.  
In case of public pools, replace injection valve rubber bands every year.

## pH Probe Maintenance

Take the pH probe out of ASIN AQUA Net housing and clean it from impurities.

Follow the instructions attached to the used probe.

## Flowmeter with filter

Rinse the flow meter sieve regularly.

# ASIN AQUA Net internet connection

The LAN connector is to be connected to the domestic router.  
Data are sent in the intervals of 10 seconds to the address  
**pool.aseko.com**, the route must not be blocked by the firewall.

Connection of ASIN AQUA Net to your LAN is not complicated. You just need some basic IT skills. If you are not enough skilled to setup the connection by your own ask your IT specialist for help.

## Possible Connection Methods

### Home network

Connect the ASIN AQUA Net to your router via LAL cable.

### Mobile network

In case you have no direct internet access you can use the data transmission over the mobile network. Connect the ASIN AQUA Net to your mobile network router via LAN cable.

### Wifi connection

If you install the ASIN AQUA Net in place where is no access to your private network by wired connection but your Wifi has enough signal, you can connect the ASIN AQUA Net to your Wifi by use of Wifi extender.

### Powerline via 230V/DC

If you have no wired access to your LAN network but your ASIN AQUA Net is in the at the same electric network you can connect the LAN network via 230 V power line socket adapter.

#### **If you have connection problems:**

Please switch off ASIN AQUA Net.

Restart the router and switch on the ASIN AQUA Net again.

The home network must be open to communication on both sides  
for URL: **pool.aseko.com**



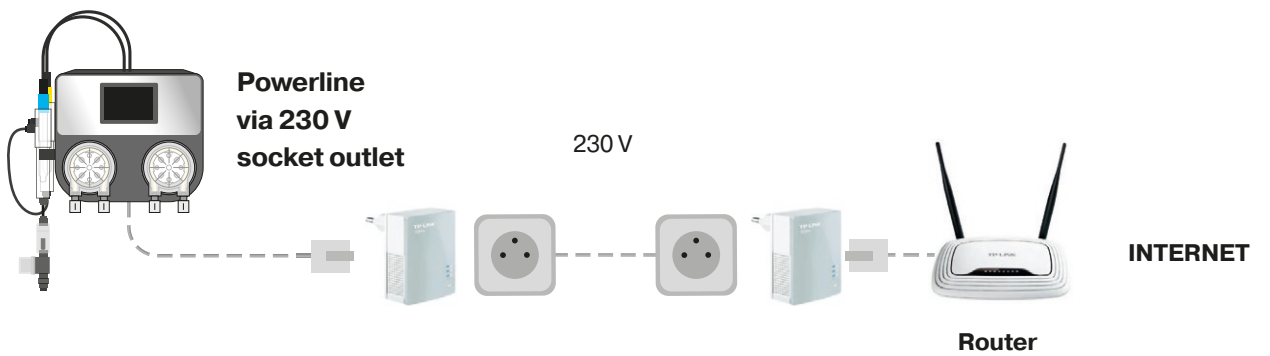
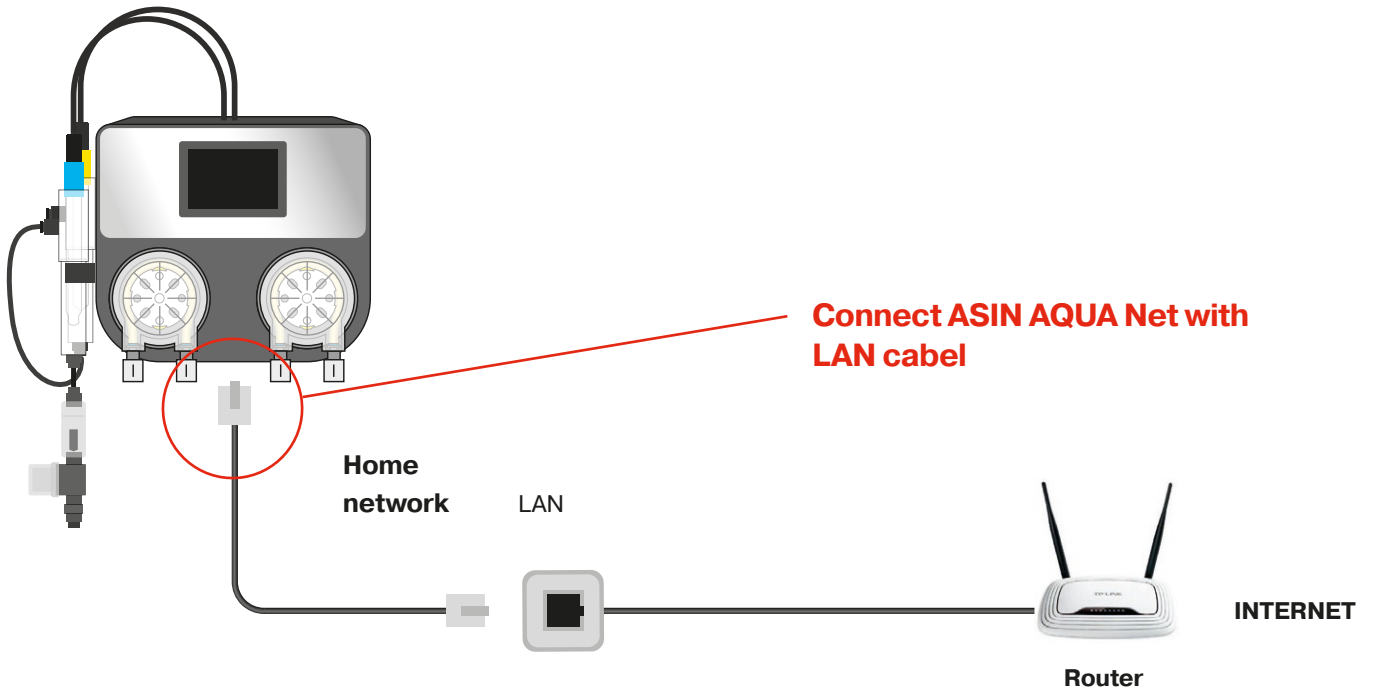

# Aseko Web Services

## Pool Live

The internet connection allows you to use the Pool Live mobile application and monitor your pool on mobile devices wheresoever the internet connection is available.

After you connect the ASIN AQUA Net to the internet download the Pool Live application to your smartphone. Application is available for iOS and Android operation systems.

Main screen after opening will ask for typing your ASIN AQUA Net serial number. If you have more pools equipped by the ASEKO NET adapter you can load all of them to one application.

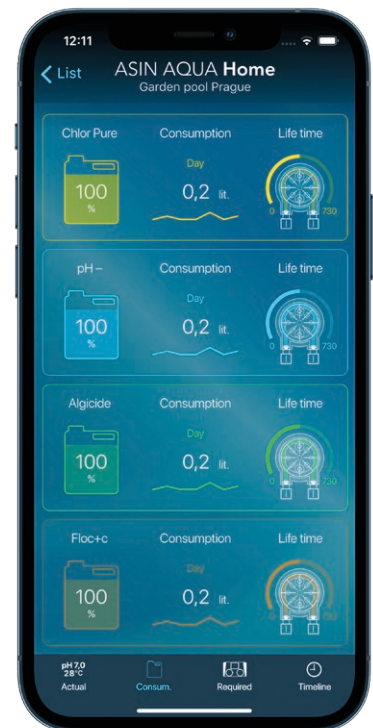
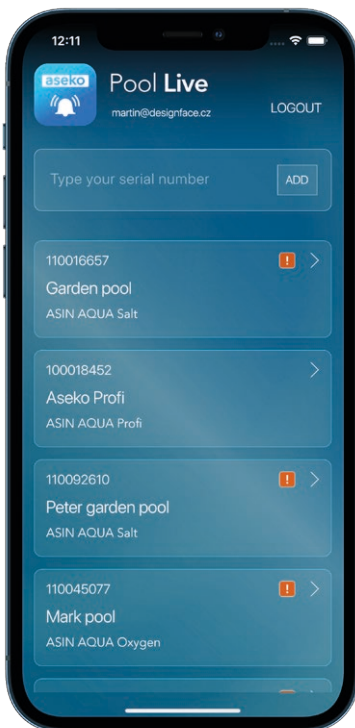

Pool LIVE  
for iOS



Pool LIVE  
for Android



## <https://pool.aseko.com>

The web application for detailed monitoring of the pool water quality by means of well-arranged graphs. It shows all the measured parameters as well as ASIN AQUA Net actions up to 30 days back.

This application is giving you the detailed information of the pool status and detailed review of all events, taken actions and act levels of monitored items up to 30 days back.

Transparent graphic environment of chart lines is giving fast report and you can easily see interconnection of monitored values.

This application is useful at public pool installations where you need to observe the history and monitor the pool water quality and maintenance. In case of any discrepancy in water quality you can find all actions, provided in that moment and in relation to other values you can diagnose the reason of such discrepancy.

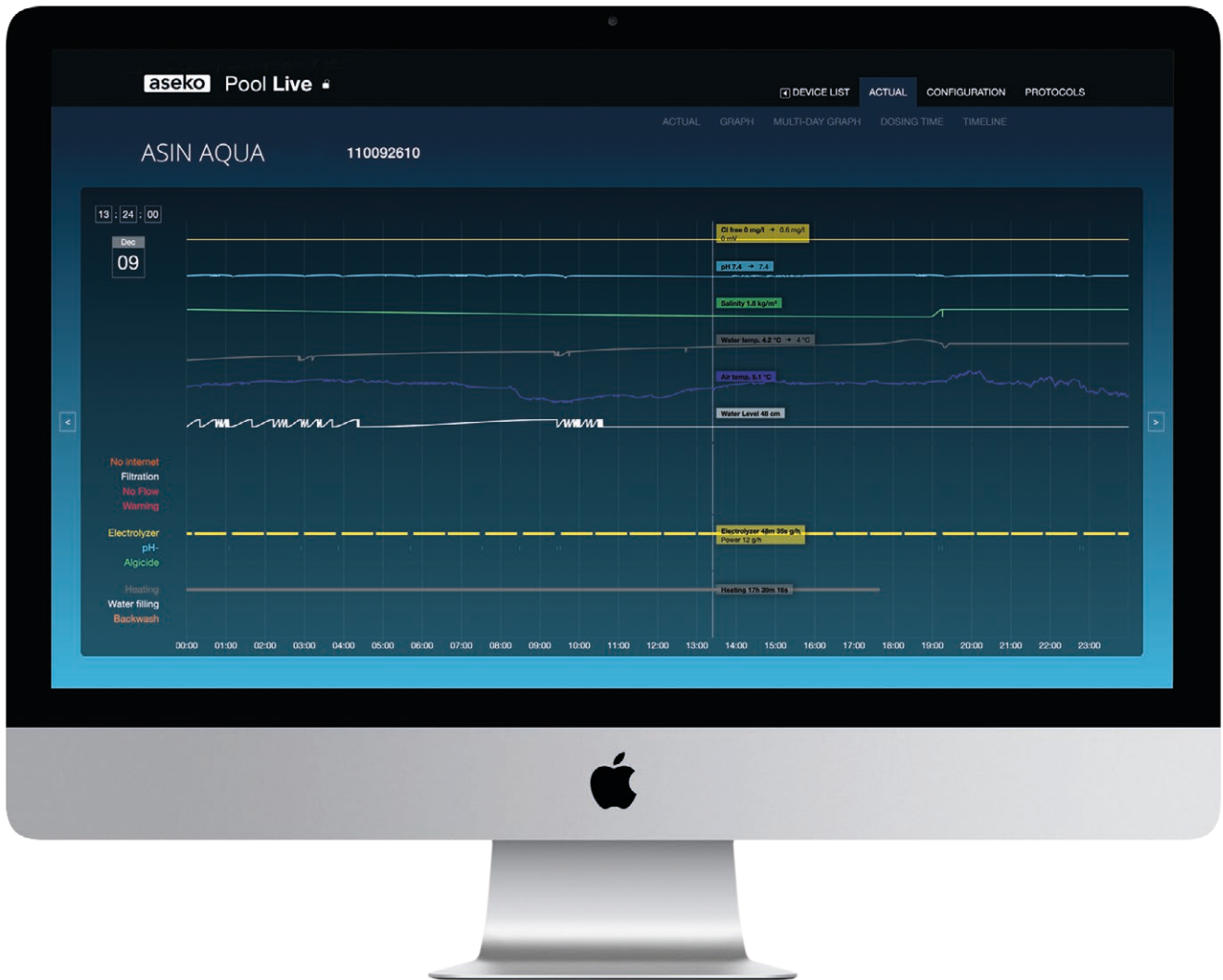

# ASIN AQUA Net error messages

After **30** doses of chlorine agent without probe response displays this error message.

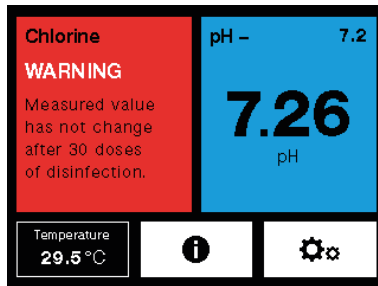

After **10/15/25** doses of pH agent without probe response displays this error message.

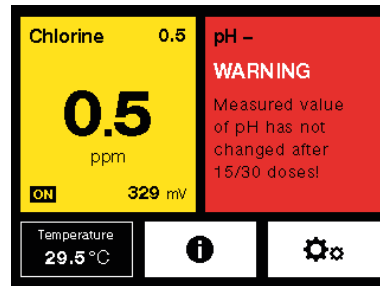

## Error messages:

### The agent has run out.

- Check the chlorine and pH agents regularly so that they do not run out. Chlorine agent concentration is 15-20%. This degrades over time and if exposed to direct sunlight.

### The dosing pump does not work.

- Check that your dosing pumps are securely fitted and not loose.
- Check the connections to your dosing pumps are secure and not leaking.
- Check the clear plastic tubes inside the dosing pumps are not damaged or broken.
- To remove your dosing pumps from your ASIN AQUA, disconnect the clear plastic tubes, turn your dosing pump counterclockwise and pull away from your ASIN AQUA.

### The dosing valve is not working.

- Check your dosing valves regularly for the build up of limescale.
- Make sure dust and dirt does not get into the containers of the chlorine and pH agent to avoid blockages and damage to the valves.
- Check the rubber seals of your valves regularly to prevent leaking.

### Water does not flow to the probes.

- Check the clear plastic tubes connection of your ASIN AQUA for damage and leaks.
- Check the connection of the clear plastic tubes to the valves for damage and leaks.
- Check the valves are properly connected to the water supply and that they are not damaged, blocked or in the closed position.

### The probe does not work.

- Replace the pH probe each year.
- Ensure your probes are clean and free from dirt.
- Exposure to below 0° C conditions damages the probes.
- Regular cleaning of the probes maintains system accuracy.

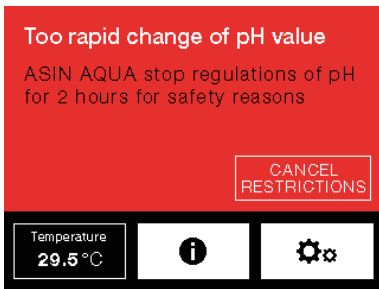

### Too Rapid pH Change

Too rapid change of pH is usually caused by refilling water directly to the skimmer. If such rapid change of pH occurs, ASIN AQUA Net stops controlling pH for two hours. This limitation can be manually disabled. After pH has been stabilized or two hours have elapsed, ASIN AQUA Net changes over to the normal mode.

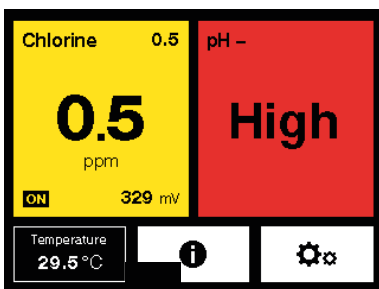

### Probe shows pH > 9

Check the water in the pool.

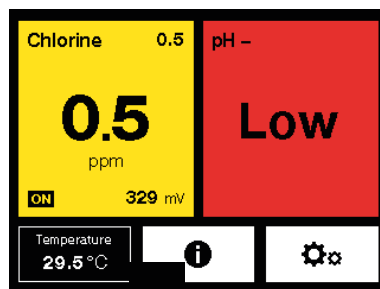

### Probe shows pH < 4

Check the water in the pool.

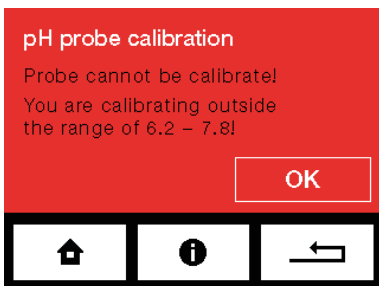

### pH calibration out of range 6,2 - 7,8

If the manually test value is outside the pH range 6,2 – 7,8 the following notification is given.

Adjust the pH of the pool water or use a pH 7.0 buffer.

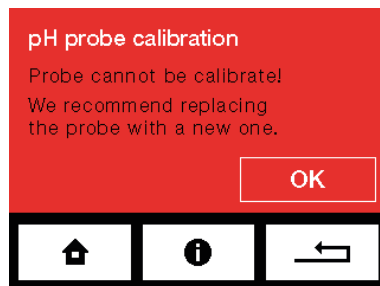

### Calibration difference greater than pH 1

If the difference between manually test and current displayed pH value is greater than 1,0 the following notification is given. It is recommended to replace the probe with a new one.

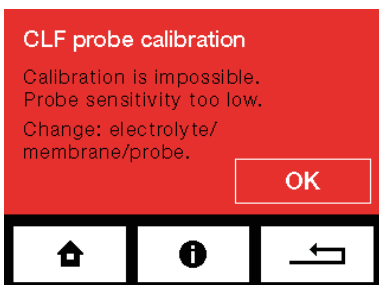

### Calibration of CLF probe

Calibration is impossible!

Probe sensitivity is too low.

Change electrolyte / membrane / probe

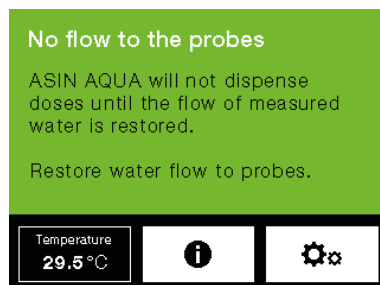

### No flow to the probes

No flow to the probes.

# Externes Touchscreen Display

Showing measured values of your pool water, humidity and temperature of the pool room where the display is installed and you can also change setup value of pH and chlorine. You can also chose which parameters you want to see on the display.



External  
Touchscreen Display  
#12048

## Thermometer

### Thermometer connection

1. Install temp. holder to the pipe system then insert the thermometer.
2. Connect the cable (2m as standard, other lengths on request) into the connector at the bottom side of the device.

### Thermometer calibration (ASIN Aqua NET)

1. In menu select SETTINGS then CALIBRATION.
2. Press THERMOMETER CALIBRATION
3. Difference can be set using – and + button.











USER'S MANUAL

# ASIN AQUA ASIN AQUA **Net**

