

ASIN Pool

INTELLIGENT NETWORK CONTROLLER
to Control the Pool Technology with Smartphone

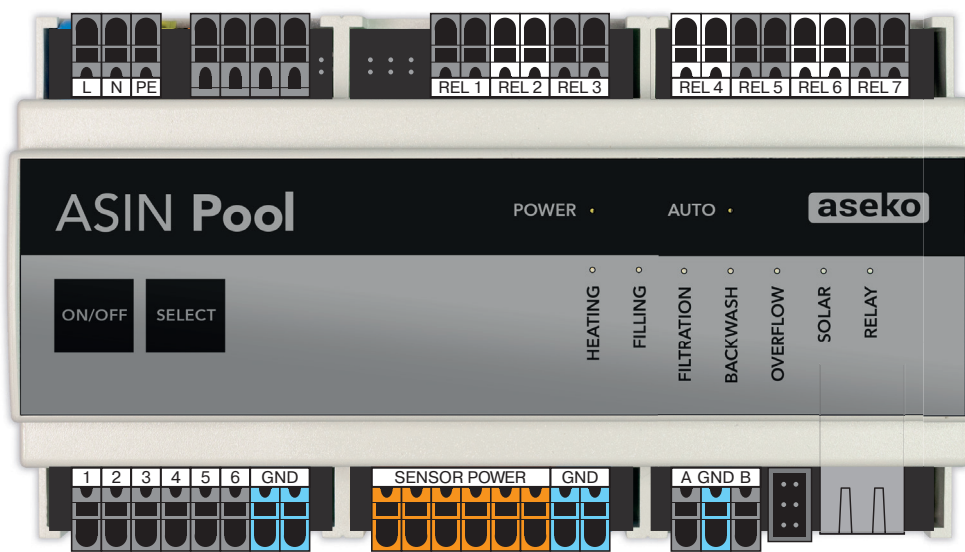

ASIN Pool



VS Pump Module



General Safety Information

This user manual has basic information that should be observed during assembly, start-up, operation, and maintenance. Therefore, this user manual must be read by installers and operators prior to assembly and start-up, and must be accessible to every user of this unit. Additionally, all further safety information in this document absolutely must be observed. Read and follow all instructions. In order to minimise the danger of injury, do not allow children to use this product. Hazards from non-compliance with safety information. Non-compliance with safety information can result in hazards to persons, the environment, and the equipment. Non-compliance with safety information will result in a forfeit of any potential right to damage compensation.

Non-Observance of Safety Instructions

Failure to observe the safety instructions given in this User Manual can result in damage to Device and/or health and property, including environment.

Failure to observe the safety instructions and information given in this User Manual shall result in exclusion or restriction of the prospective right to compensation for damage.

Insufficient Qualification of Person Using the Device

Hazards in the event of insufficiently qualified personnel,
potential consequence: Injury, heavy material damage.

- The system operator must ensure compliance with the required qualification level.
- Any and all work may only be performed by correspondingly qualified personnel.
- Access to the system must be prevented for insufficiently qualified persons, e.g. via access codes and passwords.

Connection of power supply must be provided by person with corresponding qualification. Opening the unit cover or change of any components of the unit is prohibited.

Non-compliance with informational text

There is a great deal of informational text indicating hazards and their avoidance. Not observing informational text may lead to hazards. Potential consequence: gravest degree of injury, heavy material damage.

- Read all informational text carefully.
- Cancel the process if you are unable to exclude all potential hazards.

Use of Device New Functions

Because of the continued development, a ASIN Pool® unit may contain functions, which are not completely described in this version of the user manual. The use of such new or extended functions without a profound and secure understanding by the operator may result in malfunctions and severe problems. Potential consequence: Injury, heavy material damage.

- Make sure to get a profound and secure understanding of a function and relevant boundary conditions, before you start to use it.
- Check for an updated version of the user manual or additional documentation available for the relevant functions.
- Make use of the integrated help function of the ASIN Pool® to get detailed information on functions and their parameter settings.
- In case it should not be possible to get a profound and secure understanding of a function based on the available documentation, do not use this function.

Conditions to be Met before You Start Using Device

Make sure you have a newest and updated version of the user manual and other documentation for all functions of the unit. Use and read the integrated help features. In case of not understanding the information about certain features of the unit, do not use these features.



Pool cover

Operate the pool cover only if you have clear view of the pool. Watch the pool whole time that cover is on the move. Operating the cover without the clear sight of the pool can cause serious injuries or death.

The remote control of the swimming pool cover may be in violation of the laws of your country.

ASIN Pool

ASIN Pool # 12166

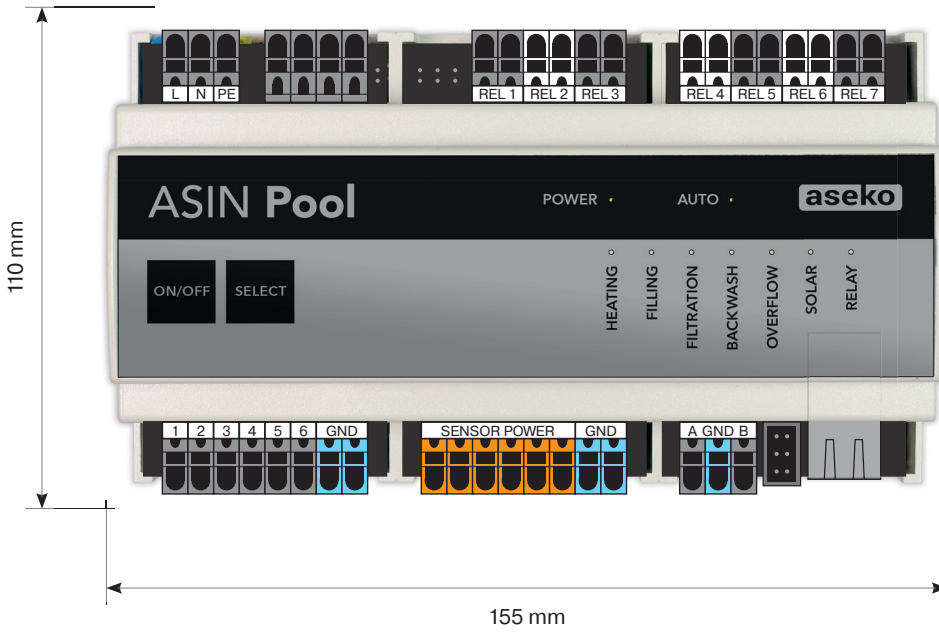

VS Module # 12167

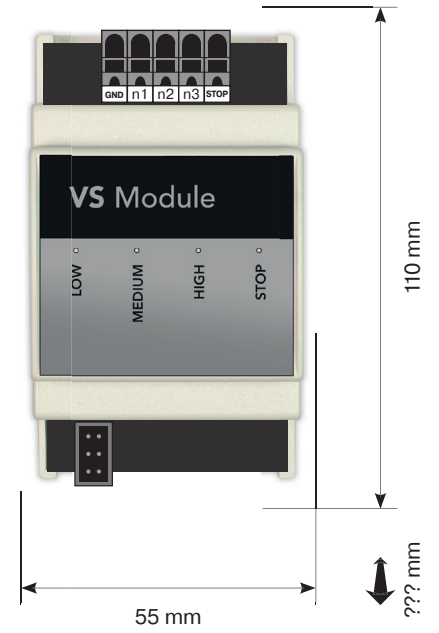

ASIN Pool Electrical Box

ASIN Pool Electrical Box # 12168



Technical specification

Power supply	110-240 VAC / 50 Hz / 60 Hz
Input power	10 VA
Overvoltage category	II
Protection degree	IP30
Climatic resistance	+5 to +40°C
Relative humidity	5 - 95% (non-condensing RH)
Weight	800 g
Installation	indoor, wall DIN rail mounting
Relay output contacts	max 230 V / 1 A, potential free contact - NO
Dimensions	155 x 110 x 60 mm and 55 x 110 x 60 mm
Sensor power supply	6 x 18 VDC / max 50mA
Maximum altitude	2 000 m
Pollution level	2 (dust)

Accessories for Purchase

Water thermometer with holder #12010



Air thermometer #8953



Solar collector thermometer #8953



Solenoid valve (water filling) #13153



5-way BESGO valve (backwash)



3-way BESGO valve (flow switch)



Pressure-type level sensor #12086



ASIN Pool

The network controller.

The ASIN Pool network controller is designed to control and set all the pool technology elements:

- Lights or pool cover
- Automatic water filling
- Solar collector pump
- Heating
- Flow control over/bottom
- Automatic filter backwash

The ASIN Pool can be set by user friendly application. The ASIN Pool is intended for the DIN rail mounting directly into the switchboard.

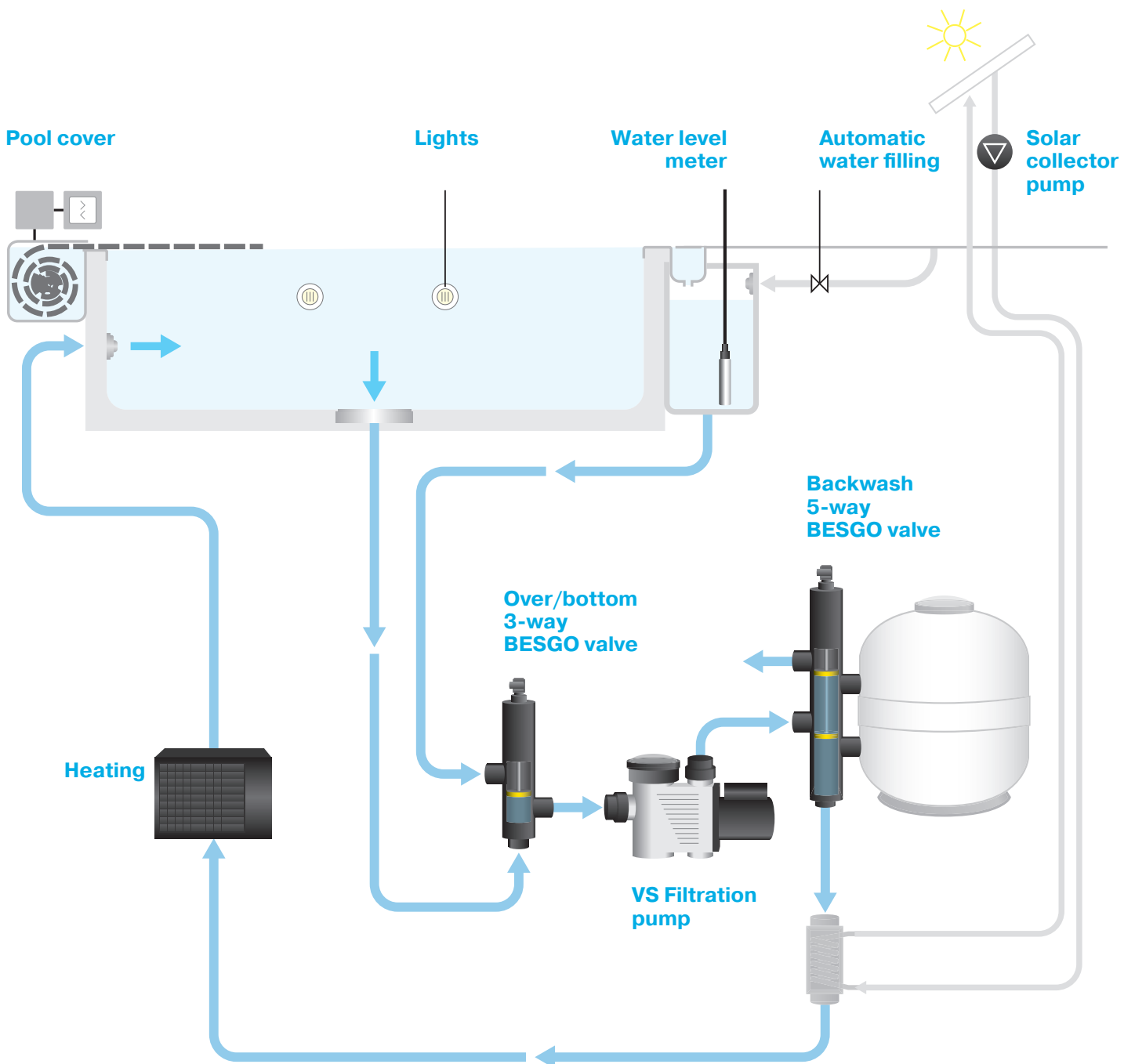



iPool REMOTE

app for
iOS and Android

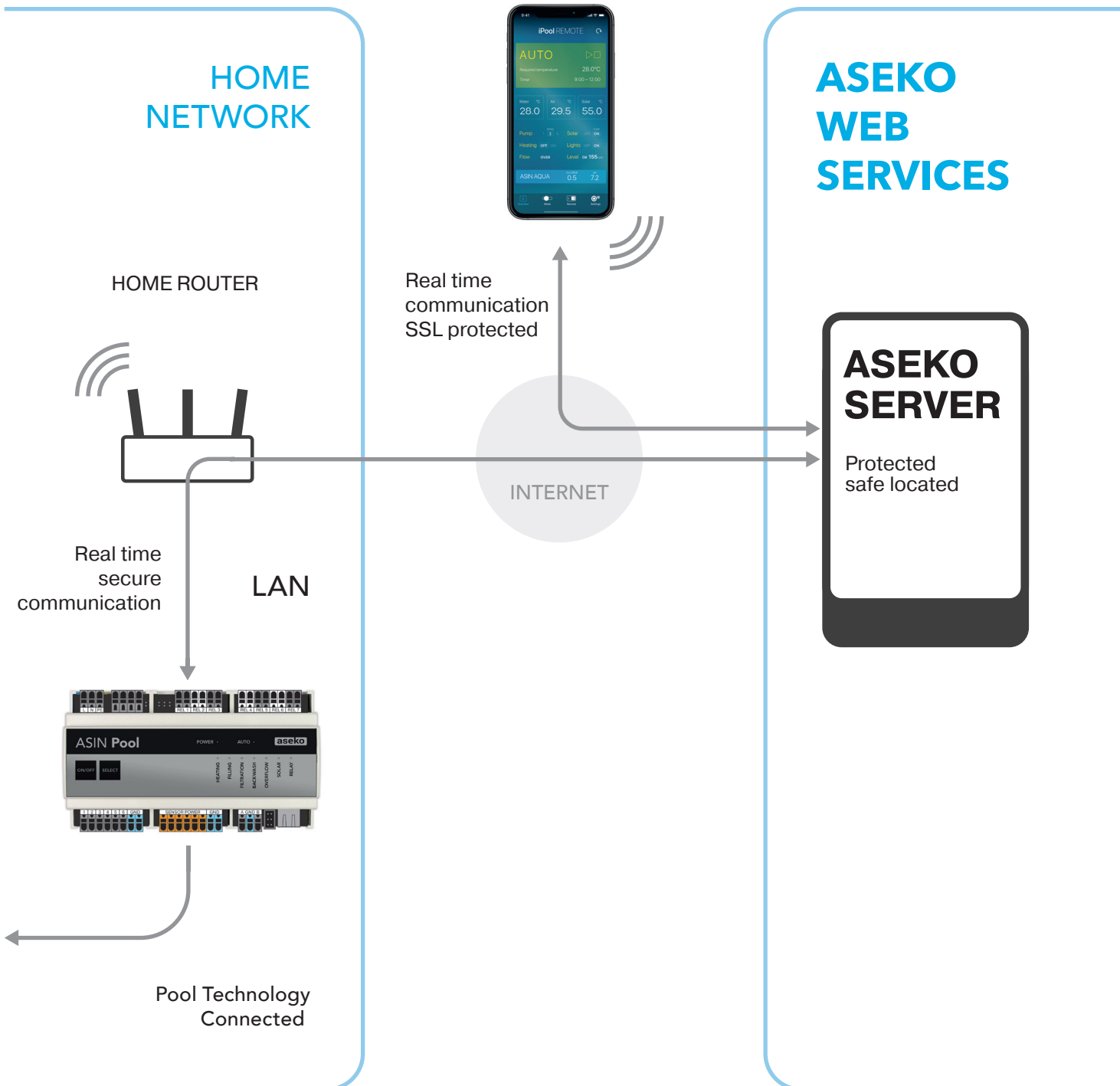

Manual Operation

For easier installation and necessary events...

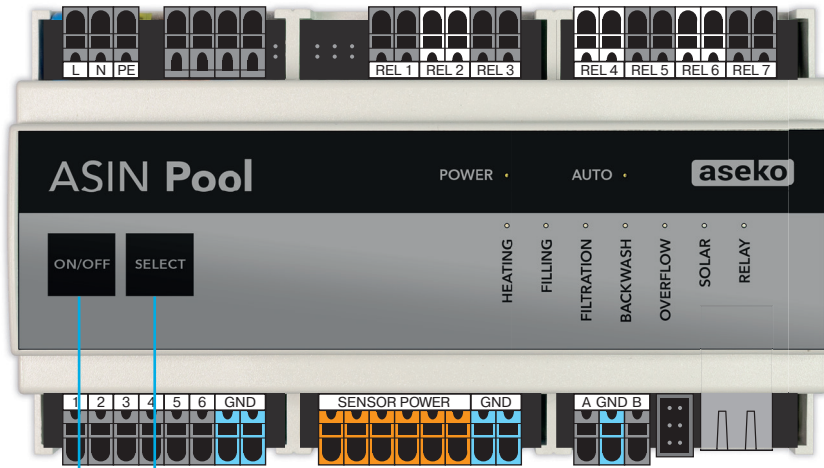

POWER:

On/Off

AUTO:

automatic mode / manual mode (testing)

Relay status indication:

ON/OFF

Turning on/off

Relay selection

Initial start

ASIN Pool will turn to standard operating mode with factory settings after the initial connection of power supply. After repeated switching on the unit continue in the original mode preset by user.

LED Power shines – signalize connected power supply

LED Auto shines – ASIN Pool works in standard operating mode with automatic control.

Manual mode

It is possible to use buttons at the front panel of ASIN Pool for simple control in testing operation when necessary to check function of connected components or in extreme cases when there is no available connection to ASIN Pool by application.

Press the button ON/OFF for switching the ASIN Pool off or on. ASIN Pool switches all outputs off and after switching on will continue in the preset mode.

Press the SELECT button to enter the manual mode. ASIN Pool will switch off all outputs and blue LED at the (HEATING) output start blinking. You can switch on or off the selected output by pressing ON/OFF button and move to next output by pressing SELECT. This way you can switch on or off all outputs. There will not blink any blue LED (after 8 press of SELECT button) and you can leave ASIN Pool or in manual mode or by pressing ON/OFF button return to automatic mode.

Operation via iPool REMOTE



iPool REMOTE

app for
iOS and Android



Mode selection

OFF All STOP

ON Nonstop filtration



PARTY Nonstop filtration, heating ON.
Mode for using the pool at the time of your wild party.



AUTO Automatic mode, heating ON
Mode for common fully automatic operation of swimming pool technology.



ECO Saving mode, heating OFF
Mode for economical operation of the pool in your absence.



WINTER Antifreeze mode
Mode for winter pool operation when not in use.

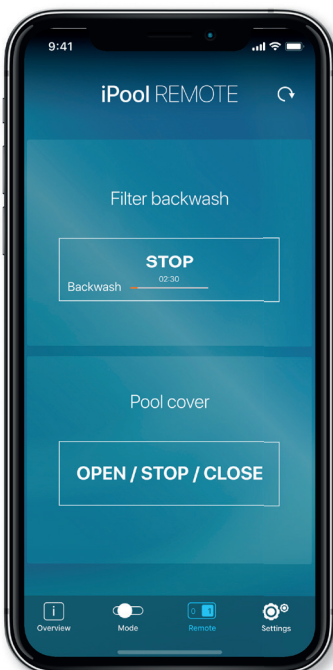

Direct control

Filter backwash

Pool cover

or

Lights

iPool REMOTE Installation



Install the iPool REMOTE application from **App Store** on iOS device or **Google play** for Android.

For iOS



For Android

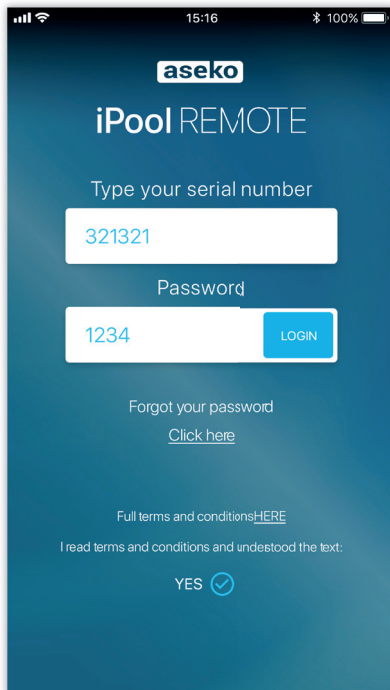

First time login

Prior to the first connection to the ASIN Pool, confirm your acceptance of "ASIN Pool Terms and Conditions".

Type your serial number

Enter the serial number of your ASIN Pool.

First time login

Please, be sure to use **1234** as a **password** for first time login.

FIRST TIME
LOGIN

Create new password

aseko

iPool REMOTE

Type your serial number

Recovery email

Create new password

Installation time zone

[Full terms and conditions](#) HERE

I read terms and conditions and understood the text.

YES

Type your serial number

Enter the serial number of your ASIN Pool.

Recovery email

Provide a valid email address to which you have access. E-mail address serves to remind the forgotten password.

Create new password

When signing in for the first time, choose a password you will use. ASIN Pool will remember the password. From this moment use the serial number and this password to log in to your ASIN Pool.

Installation time zone

Set the time zone of the ASIN Pool location.

aseko

iPool REMOTE

Type your serial number

Recovery email

Create new password

Installation time zone

[Full terms and conditions](#) HERE

I read terms and conditions and understood the text.

YES

Insatallation time zone

Prague UTC+01:00

Prague UTC+01:00

Prague UTC+01:00

Prague UTC+01:00

Prague UTC+01:00

Prague UTC+01:00

Forgotten password

To recover a forgotten password, click for reminding the password.

Overview

The screen provides all the important information about the current status of your pool and the connected components controlled by ASIN Pool.



Reload data

Actual operation mode

Water temperature, air temperature, solar panel temperature

Pool technology status

ASIN AQUA paired device status

Overview

Remote

Mode

Settings

Mode selection

The screen serves to switch between operation modes of your pool controlled via ASIN Pool.



The slider serves to control your pool operation modes.



This mode switches the circulating pump on speed MEDIUM and heating to the required temperature. This mode has no time functions.



This mode is intended for normal pool operation. Heating to your required temperature. At four time intervals per day it is possible to set the filter pump's power and set whether an overflow or bottom drain will be used.

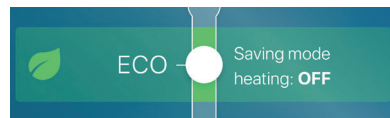

This mode is designed to operate the swimming pool in your absence or when you want to operate economically.

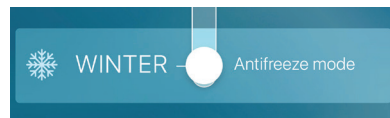

To activate this function, an outdoor thermometer must be installed*. The circulation pump switches on for 15 minutes. After 15 minutes the water temperature is measured. If the water temperature is below 4°C the heating and circulation pump is switched on. When this temperature is reached, the circulation pump is switched off. Further control of the water temperature and switching on of the circulation pump will happen in 6 hours.

*) If outdoor temperature is below 0°C

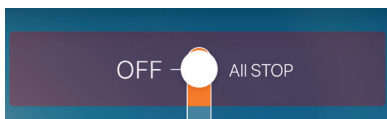

All off, only in case of solar panels reach the preset temperature the filter pump and solar circulation pump are switched on.



Filter pump is set on MEDIUM speed. This mode has no time functions. The water flow is set to OVER, and heating is set to OFF.

Direct control

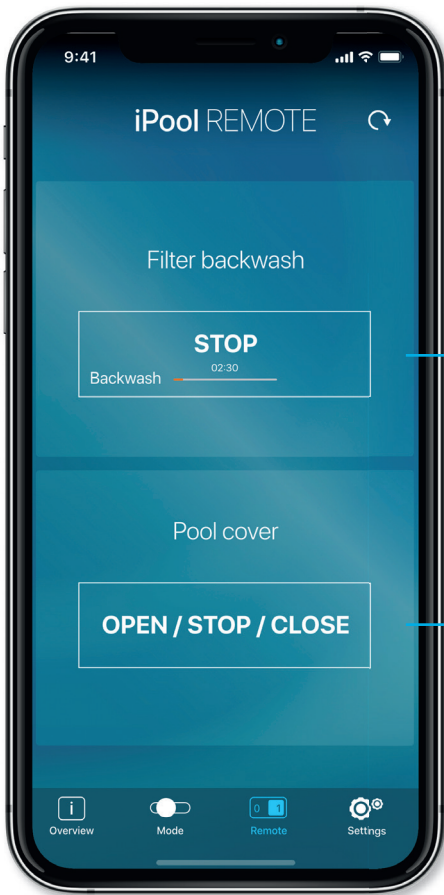

Switches on the filter backwash process

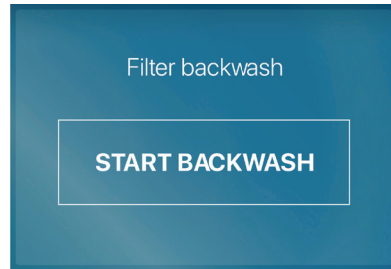

Open / close cover

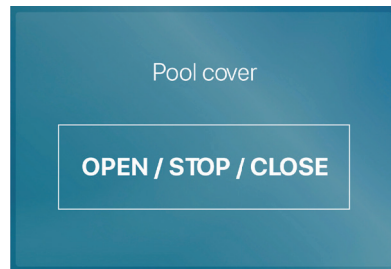

or

Turns the lights on/off

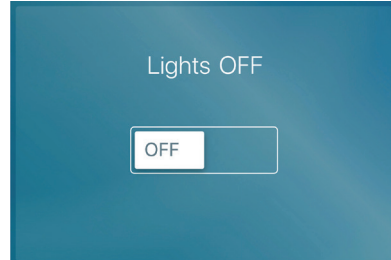

Settings

The screen serves to set the ASIN Pool and parameters of each mode including the filtration timer.

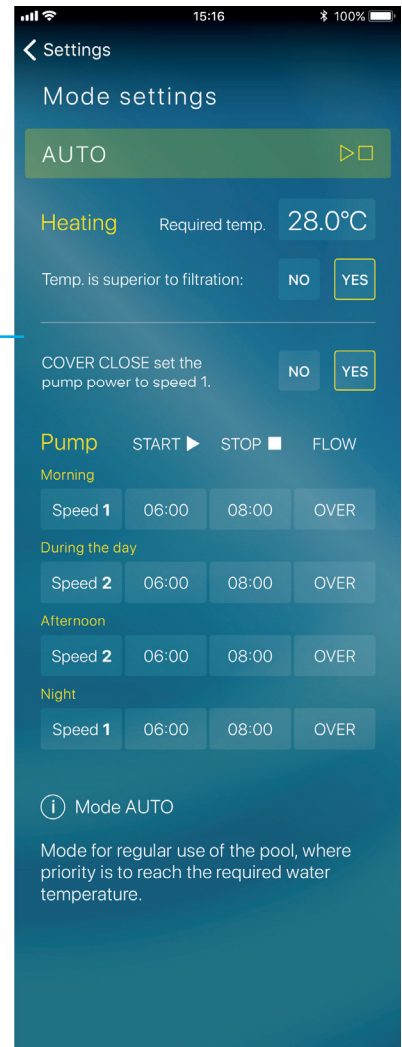
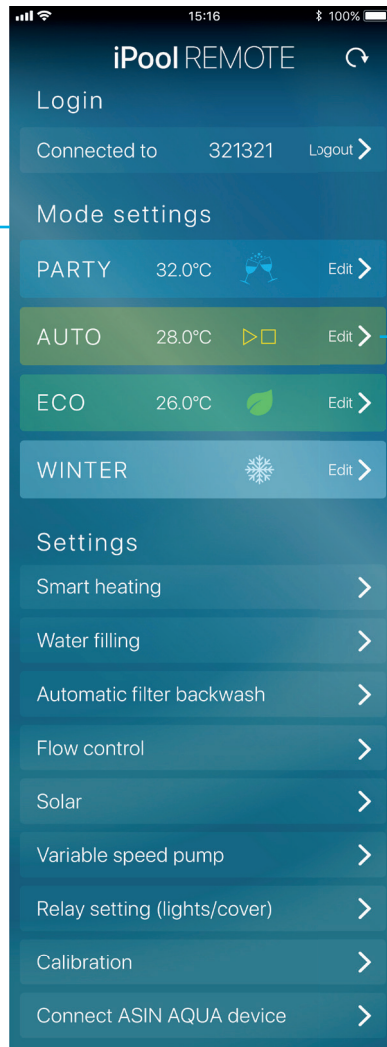
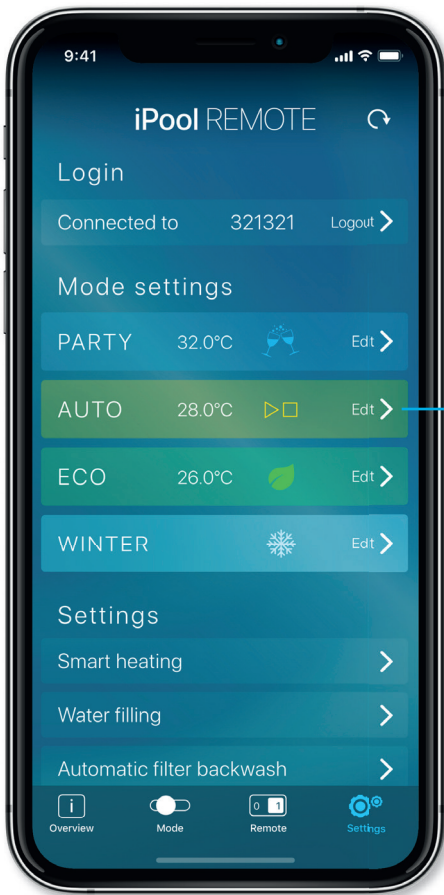

Smart heating

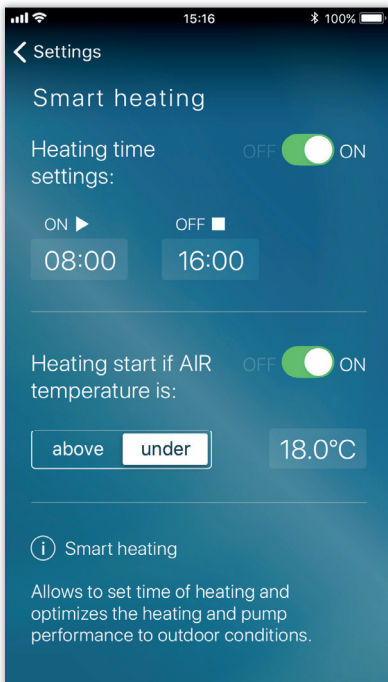
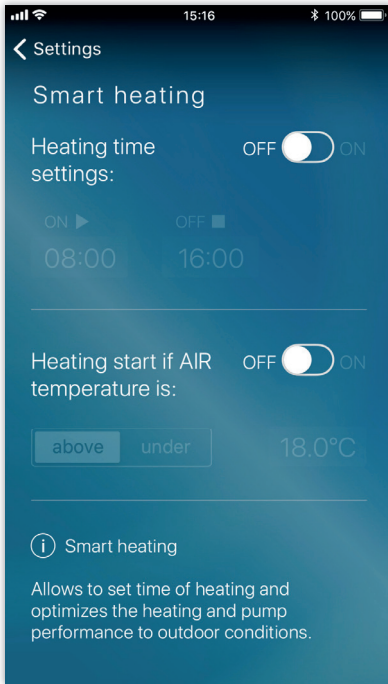

Heating at Time

This function allows to set time of heating operation. This is particularly useful for switching on the heat pumps that have higher efficiency during the day time when outdoor temperature is higher.

Heating at air Temperature

This function allow you to customize the pool heating and achieve the highest possible efficiency of the heat pump.

“I heat just when the outdoor temperature is higher than, or I heat just till the outdoor temperature reaches”

The high-accuracy electronic thermometer is used for water temperature measurement. It should be installed to the inlet pipe coming from the pool. Never install it downstream of the heat exchanger. Significant distortion of temperature would occur.

When temperature drops below the required value, the relay No. 1 switches on the heat source (heat pump, electric heating, gas boiler circulating pump).

Temperature Control Takes Priority over Filtration Control

If you select the temperature control to take priority over the filtration timer, heating as well as the circulating pump will be in operation even after the adjusted time of filtering. The circulation pump will stop after the required temperature is achieved. It will restart at next preset period of the timer.

Water filling

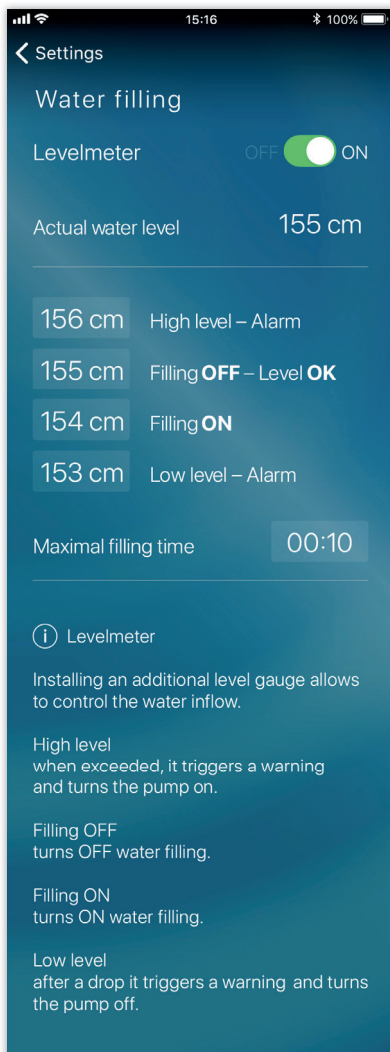

The water level is measured by the level sensor. This allows very easy installation by inserting the sensor into the balance tank or skimmer.

Water Level is controlled at four adjustable levels that are easily entered in centimetres.

The level sensor cable must not be broken anywhere in order to prevent the balancing tube that is a part of the cable from being clogged.

High level

Too much water in the pool

When this level is reached:

1. The circulating pump starts
2. If the automatic filter backwash is enabled, one filter backwash cycle starts.

Level OK

Filling stops

Filling ON

Level at which pool filling starts

Filling starts after one minute during which the level is permanently below this value in order to prevent oscillating

Low level

The circulating pump as well as heating will be disabled

Maximum filling time

The maximum filling time acts as protection for case of any failure of the level measuring. This function will switch off the pool filling after the adjusted time has elapsed regardless of a level sensor signal.

ASIN AQUA should be switched off during the filling.

This function is implemented in ASIN Pool Electrical Box.

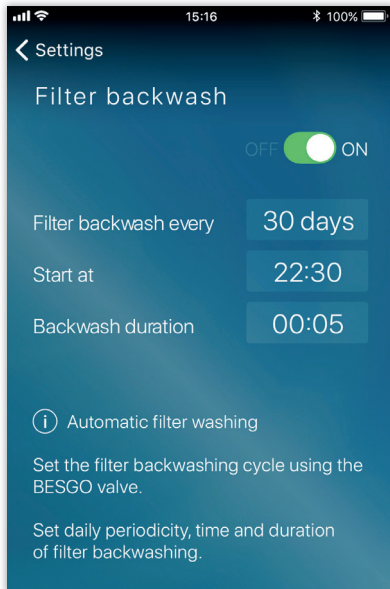

Automatic Filter Backwash

The automatic backwash function ensures the filter backwash on a regular basis in the preset intervals. To enable this function is necessary to use the automatic 5-way BESGO valve. Its moving controlled by the relay switching on/off. When the relay switches on, the BESGO valve is activated and moved to the required position by the action of pressure water or air. See the BESGO manual.

ASIN AQUA should be switched off during the backwash.



Flow control Overflow/Bottom

To use this function, it is necessary to install the 3-way BESGO switching valve. It is possible to make a decision whether water shall circulate through the overflow or the bottom drainage.

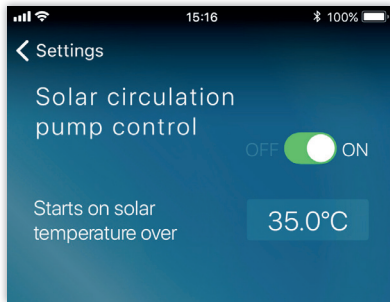

Solar

The ASIN Pool allows control of the solar heating. To enable this function it is necessary to install the outdoor thermometer to the solar collector. At the preset temperature of the solar collector, e.g. 40°C, solar system circulating pump as well as the filter pump will start on. This start takes absolute priority over other settings in order to prevent the solar collector from being overheated.



Variable speed Pump Control

The ASIN Pool with the additional VS Pump module enable to control the power of circulating pumps with a variable drive. Power can be selected at preset periods in individual modes. In case of backwashing, the pump is running at speed HIGH. Individual speeds LOW, MEDIUM, HIGH are adjusted directly on the pump according to the respective pump manual. In case of use of pool cover the pump can slow down to speed LOW if pool cover is closed.

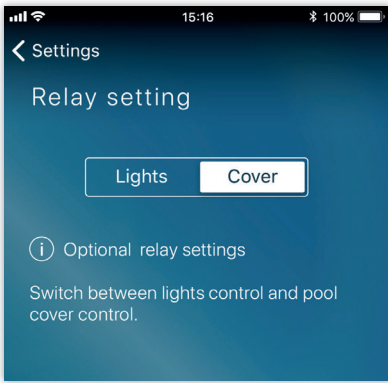

Relay settings (lights/cover)

Optional relay settings, switch between lights control and pool cover control.

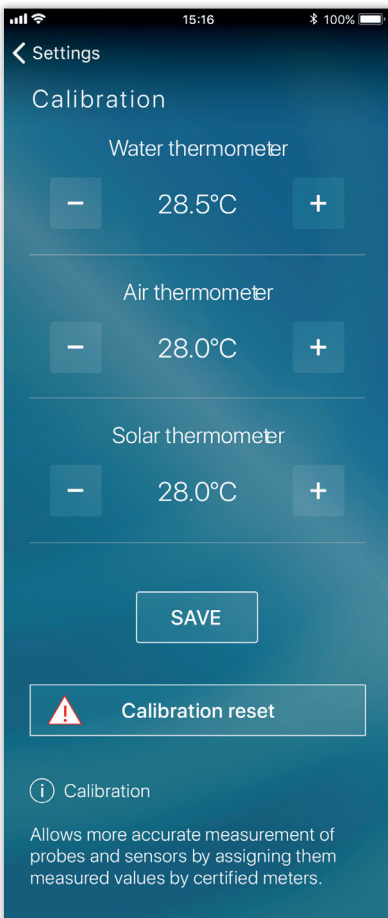

Calibration

Allows more accurate measurement of probes and sensors by assigning them measured values by certified meters.

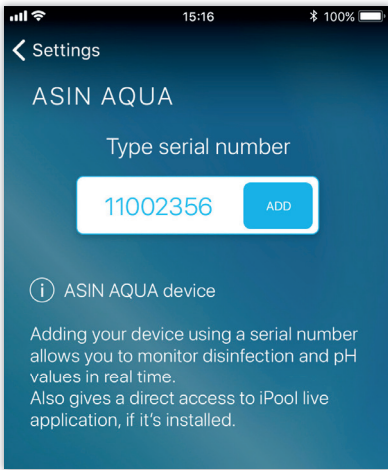

Connect ASIN AQUA device

Adding your device using a serial number allows you to monitor disinfection and pH values in real time.

Also gives a direct access to iPool live application, if it's installed.

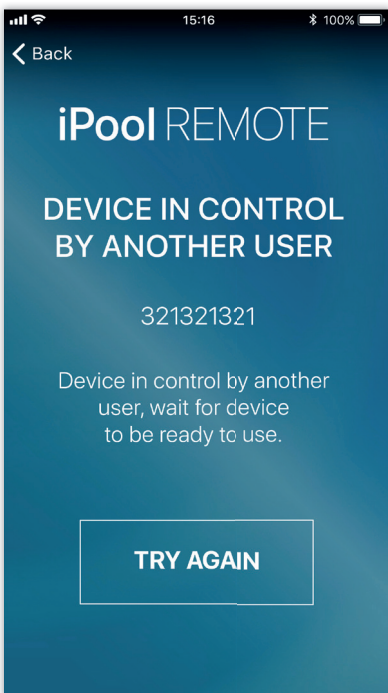

Device in control by another user

Device in control by another user, wait for device to be ready to use.

Time delay is 30 s.

Warning messages

High level – start FILTER BACKWASH

High level runs one backwash procedure. If the level does not drop, an error message is displayed.

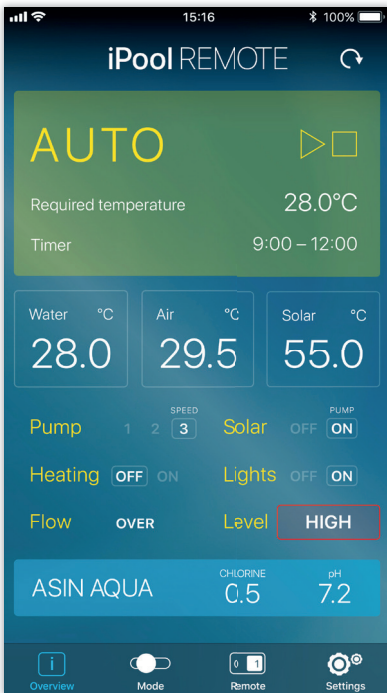

High level – ALARM

To lower the level, run the filter backwash. Pump ON.

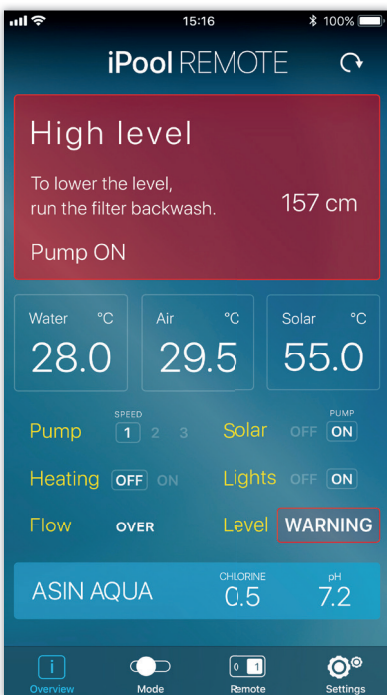

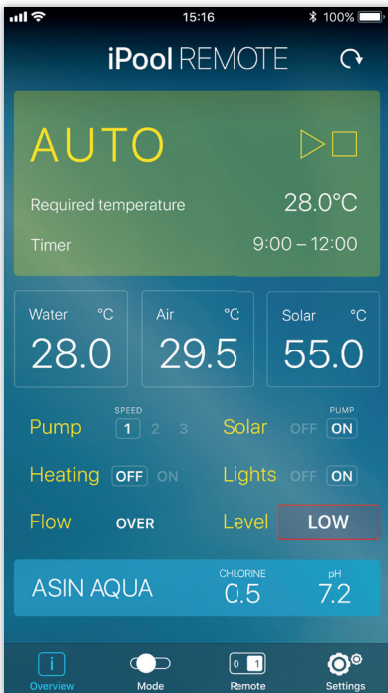

Low level

Start water filling.

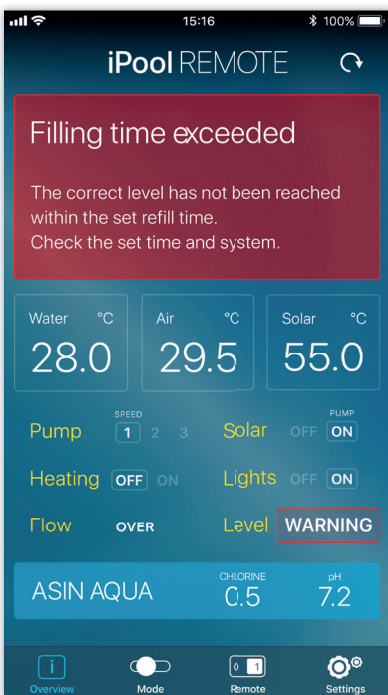

Filling time exceeded

The correct level has not been reached within the set refill time.
Check the set time and system.

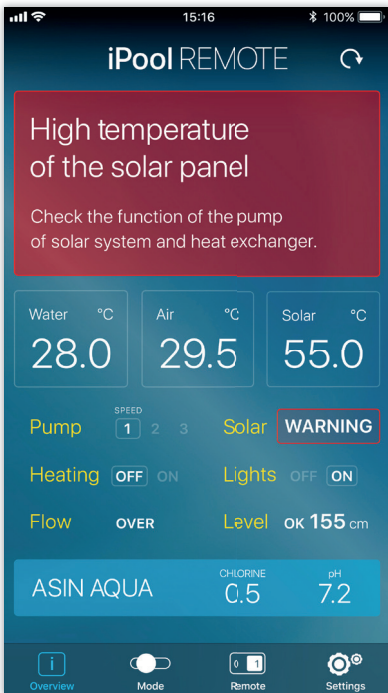

High temperature of the solar panel

Check the function of the pump of solar system and heat exchanger.

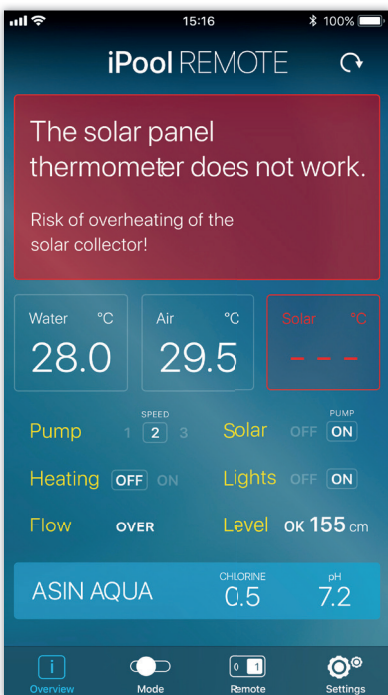

The solar panel thermometer does not work

Risk of overheating of the solar collector!

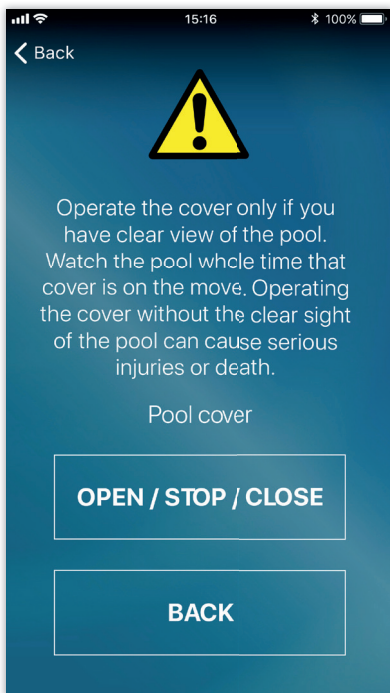

Pool cover

Operate the cover only if you have clear view of the pool. Watch the pool whole time that cover is on the move. Operating the cover without the clear sight of the pool can cause serious injuries or death.

Installation

All connections must be made only when the units is disconnected from power supply!

Wiring of relay outputs may be realized by wire with maximum 2,5 mm². Maximum relay load is 230 V AC / 1A.

Power supply cable by CYKY 2x1,5 should be equipped by single pole circuit breaker 6A/250V, characteristic B signed as ASIN Pool.

Do not forget to add suitable RCD, for example 16A(B)/30mA.

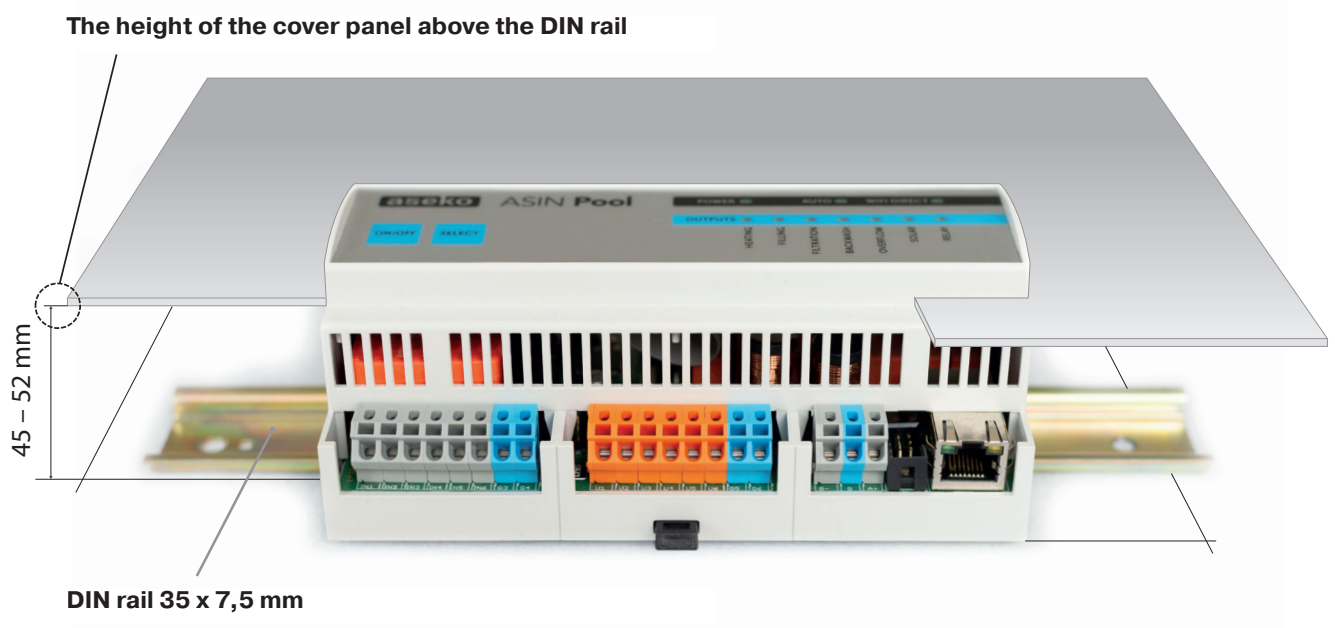
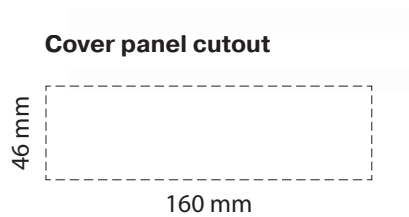

Maintenance

ASIN Pool system and connected sensors does not require any special maintenance. Protect all vent outlets against overlapping.

Servis

In case of need any additional info or service, contact the manufacturer:

ASEKO, spol. s r.o.

Vídeňská 340, Vestec u Prahy, 252 50

IČ: 40766471, DIČ: CZ40766471

Telefon: +420 244 912 210, +420 603 500 940

E-mail: aseko@aseko.cz

Sensors Connection

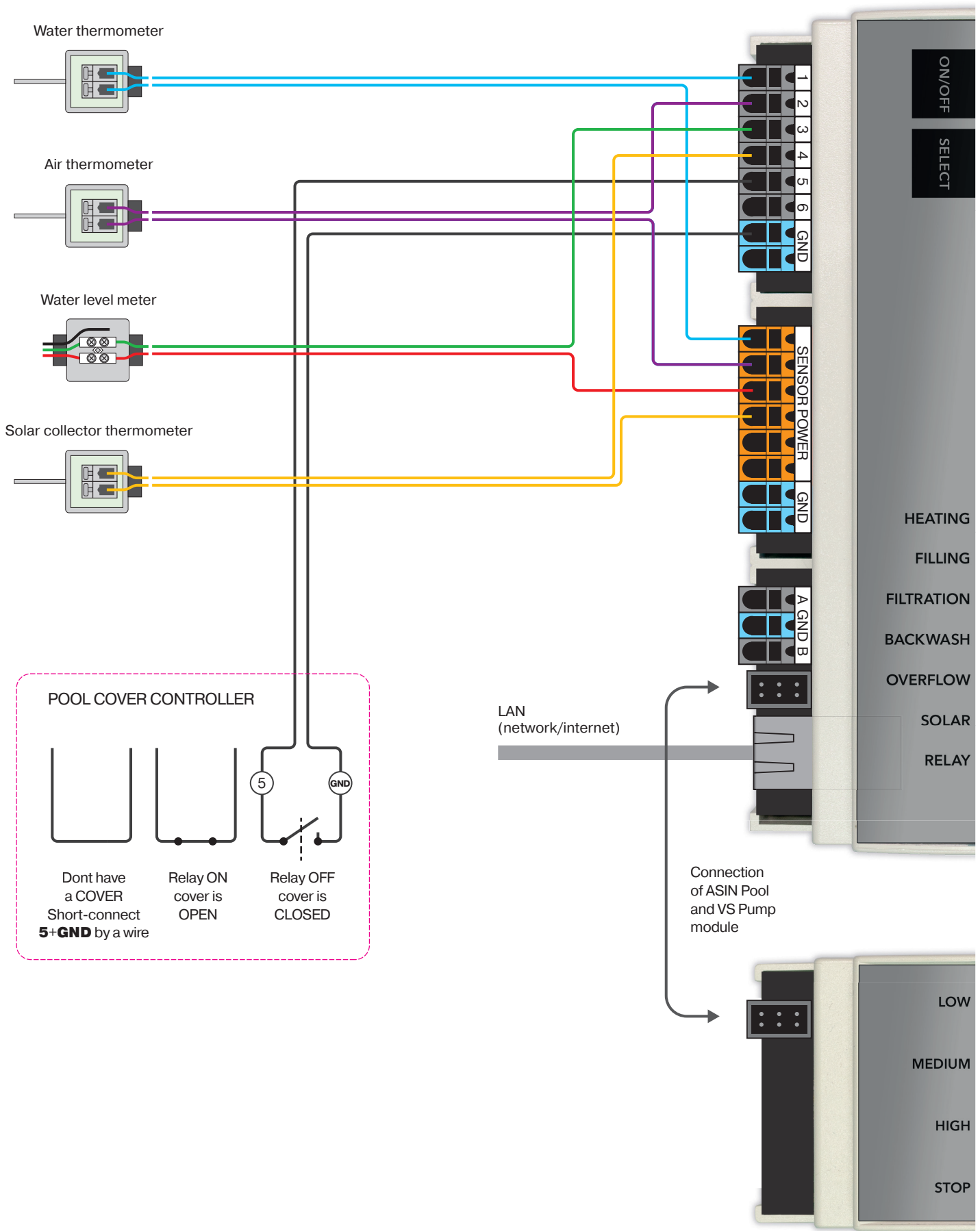

Electrical Connection

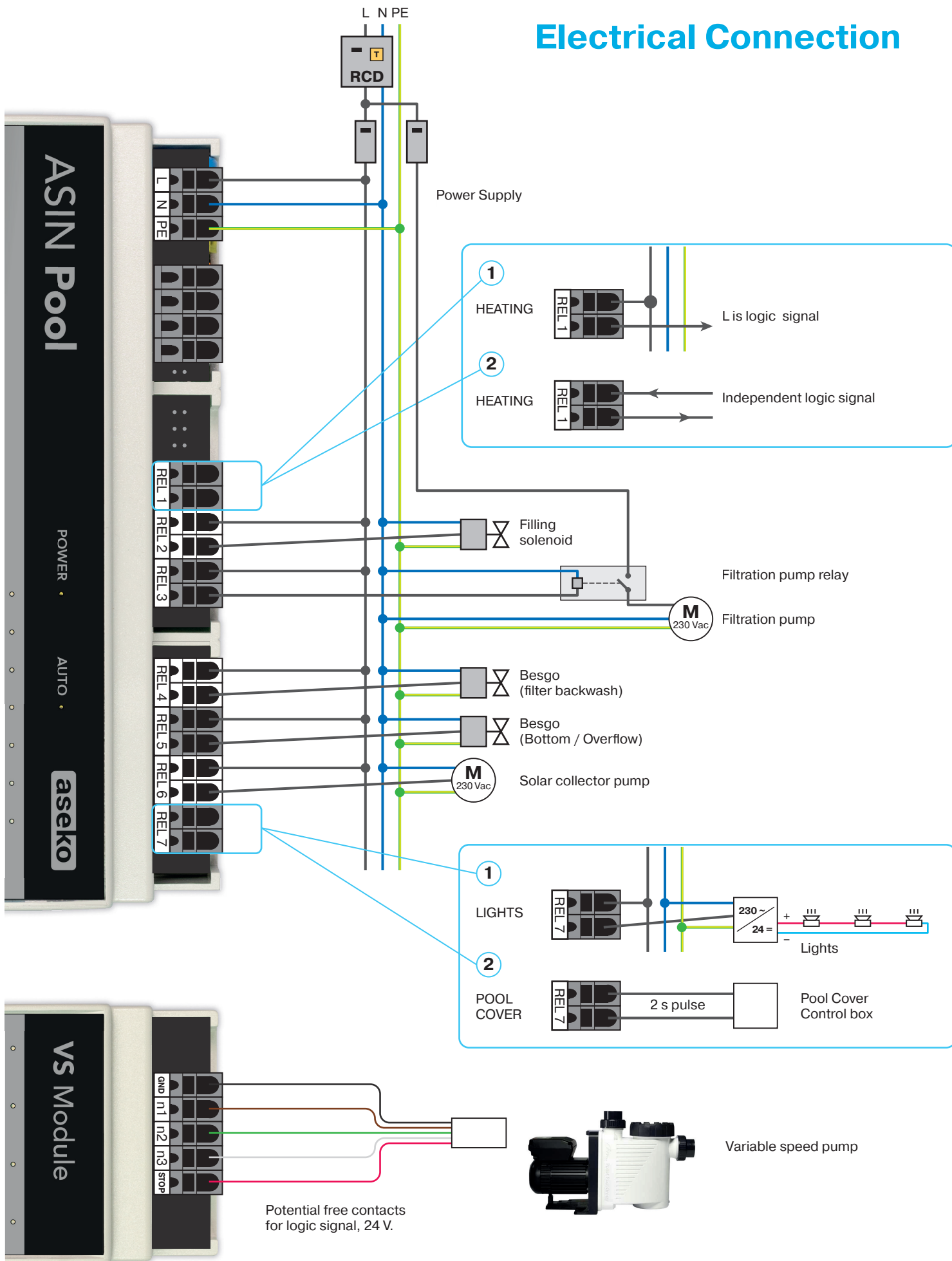

ASIN Pool Electrical Box



Preinstalled in Electrical Box.
ASIN Pool + VS Module.

