



Hydroxinator® iQ

Instructions for installation and use - English
Magnesium electrolyser, pH/Redox regulation
Translation of the original instructions in french

EN



pH Link / Dual Link



More documents on:
www.zodiac.com

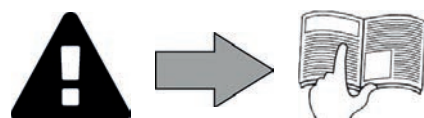

WARNINGS

GENERAL WARNINGS

- Failure to respect the warnings may cause serious damage to the pool equipment or cause serious injury, even death.
- Only a person qualified in the technical fields concerned (electricity, hydraulics or refrigeration) is authorised to perform this procedure. The qualified technician working on the appliance must use/wear personal protective equipment (such as safety goggles and protective gloves, etc.) in order to reduce the risk of injury occurring when working on the appliance.
- Before handling the machine, ensure that it is switched off and isolated.
- The appliance is intended to be used for pools and spas for a specific purpose; it must not be used for any purpose other than that for which it was designed.
- It is important that the appliance is operated by people who are competent and qualified (both physically and mentally), after having read the instructions for use. All persons not meeting these criteria must not approach the appliance in order to avoid exposure to dangerous elements.
- Keep the appliance out of the reach of children.
- The appliance must be installed according to the manufacturer's instructions and in compliance with local standards. The installer is responsible for installing the appliance and for compliance with national installation regulations. Under no circumstances may the manufacturer be held liable in the event of failure to comply with applicable local installation standards.
- For any work other than the simple user maintenance described in this manual, the product should be referred to a qualified professional.
- Incorrect installation and/or use may cause serious damage to property or serious injuries (possibly causing death).
- All equipment, even postage and packing paid, travels at the risks and perils of the recipient. The latter shall issue reserves in writing on the carrier's delivery slip if damage is detected, caused during transport (confirmation to be sent to the carrier within 48 hours by registered letter). In the event that an appliance containing coolant has been turned on its side, mention your reservations in writing to the carrier.
- If the appliance suffers a malfunction, do not try to repair it yourself; instead contact a qualified technician.
- Refer to the warranty conditions for details of the permitted water balance values for operating the appliance.
- Deactivating, eliminating or by-passing any of the safety mechanisms integrated into the appliance shall automatically void the warranty, in addition to the use of spare parts manufactured by unauthorised third-party manufacturers.
- Do not spray insecticide or any other chemical (both flammable and non-flammable) in the direction of the appliance, as this may damage the body and cause a fire.
- Zodiac® heat pump, filter pump and filter appliances are compatible with the most commonly used types of pool water treatment systems.
- Do not touch the fan or moving parts and do not place a rod or your fingers in the vicinity of the moving parts during operation of the appliance. Moving parts can cause serious injury or even death.

WARNINGS ASSOCIATED WITH ELECTRICAL APPLIANCES

- The power supply to the appliance must be protected by a dedicated 30 mA residual current device, complying with the standards and regulations in force in the country in which it is installed.
- Do not use any extension lead when connecting the appliance; plug the appliance directly into a suitable wall socket.
- Before carrying out any operations, check that:
 - The voltage indicated on the appliance information plate corresponds to the mains voltage.
 - The power grid is adapted to the power requirements of the appliance, and is grounded.
 - The plug (where applicable) is suitable for the socket.
- In the event of abnormal operation or the release of odours from the appliance, turn it off immediately, unplug it from its power supply and contact a professional.
- Before any intervention on the appliance, ensure that the appliance is switched off and disconnected from the power supply. Additionally, heating priority (if applicable) should be deactivated and all power to any other equipment that may be connected to the appliance should also be disconnected.
- Do not disconnect and reconnect the appliance to the power supply when in operation.
- Do not pull on the power cord to disconnect it from the power supply.
- If the power cord is damaged, it must be replaced by the manufacturer, its technician or a qualified person to guarantee safety.
- Do not perform maintenance or servicing operations on the appliance with wet hands or if the appliance is wet.
- Clean the terminal board or the power supply socket before connection.
- For any component or sub-assembly containing a battery: do not recharge or dismantle the battery, or throw it into a fire. Do not expose it to high temperatures or direct sunlight.
- In stormy weather, unplug the appliance to prevent it from suffering lightning damage.
- Do not immerse the appliance in water (with the exception of cleaners) or mud.

SPECIFIC FEATURES APPLICABLE TO "Pool cleaners"

- The cleaner must operate in pool water at a temperature of between 15°C and 35°C.
- To avoid possible injury or damage to the cleaner, do not operate the cleaner out of the water.
- In order to prevent possible injury, bathing is prohibited when your cleaner is in the pool.
- Do not use the cleaner during shock chlorination.
- Do not leave the cleaner unattended for an extended period.

WARNING ON THE USE OF A CLEANER IN A POOL WITH A VINYL SURFACE:

- Before installing your new cleaner, carefully inspect the lining of your pool. If the liner has eroded in some areas, or if you notice gravel, folds, roots or corrosion caused by metal beneath the liner, or if you notice that the surface (bottom and walls) is damaged, do not install the cleaner before performing the necessary repairs or before having the liner replaced by a qualified professional. The manufacturer may not be held liable in any way for damage caused to the liner.
- The surface of certain vinyl patterned surfaces can wear rapidly and the patterns disappear on contact from objects such as cleaning brushes, toys, inflatable buoys, chlorine distributors and automatic pool cleaners. The decoration on some vinyl surfaces can be scratched or worn by basic friction such as through the use of a pool brush. The colours of certain patterns can also be erased during use or when in contact with objects in the pool. The manufacturer may not be held liable for the erased patterns, wear or scratching of vinyl surfaces, which are not covered by the limited warranty.

Recycling



This symbol means that your appliance must not be thrown into a normal bin. It will be selectively collected for the purpose of reuse, recycling or transformation. If it contains any substances that may be harmful to the environment, these will be eliminated or neutralised.

Contact your retailer for recycling information.

CONTENTS



1 Specifications

3

1.1 | Package content

3

1.2 | Technical specifications

5



2 Installing the device

6

2.1 | Installing the cell

6

2.2 | Installing the temperature sensor

7

2.3 | Installing the flow switch (device only without pH Link or Dual Link modules)

7

2.4 | Installing the control box

8

2.5 | Electric connections

9



3 Installing a pH Link or Dual Link module

13

3.1 | Installing the POD kit

13

3.2 | Installing the flow switch on the POD kit

16

3.3 | Installing the sensors on the POD kit

17

3.4 | Installing the pH minus injection and suction pipes

18



4 Pool preparation

20

4.1 | Filtration and filter medium

20

4.2 | Water balance

21

4.3 | Adding minerals

22



5 Use

23

5.1 | User interface

23

5.2 | Settings required prior to use

23

5.3 | Calibrating the sensors (if an optional pH Link or Dual Link module is installed)

32

5.4 | Regular use

37



6 Maintenance

39

6.1 | Cleaning the sensor(s)

39

6.2 | Checking and cleaning the electrodes

40

6.3 | Washing the pool filter (backwash)

40

6.4 | Winterizing

41

6.5 | Returning the pool to service

41



7 Troubleshooting

42

7.1 | Appliance behaviour

42

7.2 | Effects of the stabiliser on the chlorine and the ORP

44

7.3 | "Help" menu

44

EN



- Before handling the appliance, it is vital that you read this installation and user manual, as well as the "warnings and warranty" booklet delivered with the appliance. Failure to do so may result in material damage or serious or fatal injury and will void the warranty.
- Keep and pass on these documents for later consultation during the appliance's service life.
- The distribution or modification of this document in any way is prohibited, without prior authorisation from Zodiac®.
- Zodiac® is constantly developing its products to improve their quality. The information contained herein may therefore be modified without notice.



1 Specifications

1.1 | Package content

1.1.1 Chlorinator

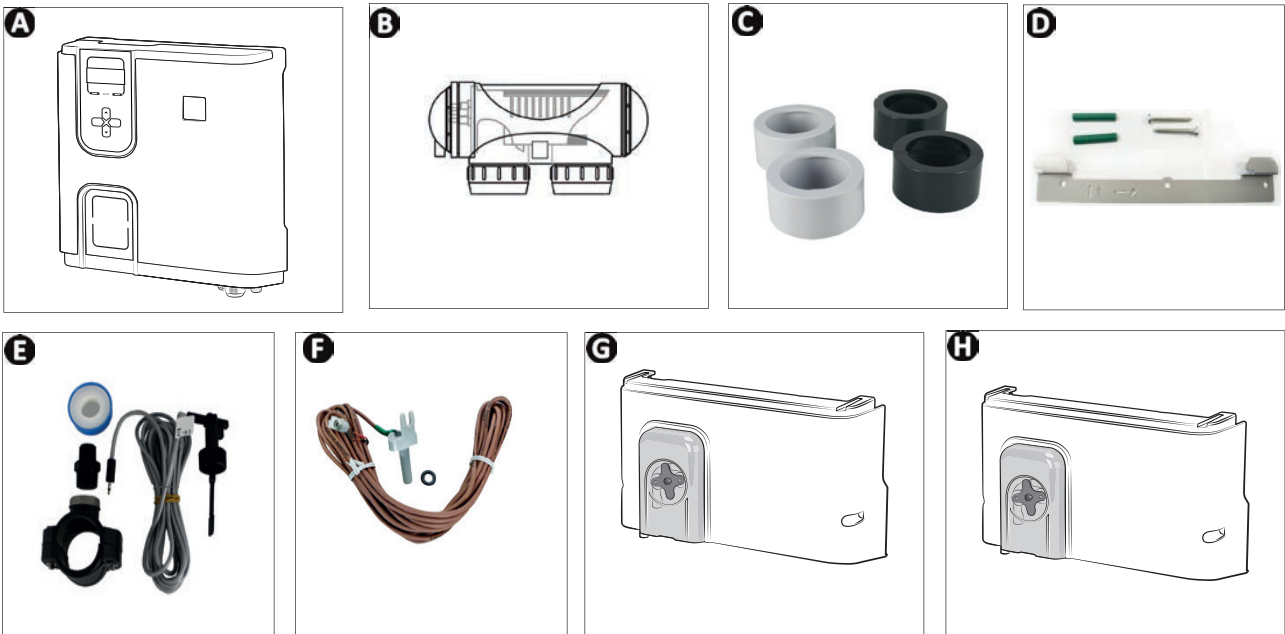

		Hydroxinator® iQ
A	Control box	✓
B	Electrolytic cell	✓
C	Glue-on adapter and union coupling kit for electrolytic cell	✓
D	Hanging bracket wall-mounting kit	✓
E	Flow rate detector with installation kit	✓
F	Temperature sensor with installation kit	✓
G	pH Link module (for measuring and automatically regulating pH levels)	+
H	Dual Link module (for measuring and automatically regulating pH and chlorine levels)	+

✓: Supplied

+: Available as an option

1.1.2 Optional pH Link or Dual Link modules



EN

		pH Link	Dual Link
A	pH Link or Dual Link modules	✓	✓
B	POD kit	✓	✓
C	Hole saw for installing the POD kit	✓	✓
D	Threaded sensor holder(s)	✓ _{x1}	✓ _{x2}
E	pH sensor + pH 7 (x3) & pH 4 (x3) buffer solutions	✓	✓
F	ORP sensor + ORP 470 mV (x3) buffer solutions		✓
G	Suction + injection hose (5 metres)	✓	✓
H	Assembly accessories bag (2 threaded caps, 1 ceramic weight with support tip, Teflon tape)	✓	✓

✓: Supplied

➤ 1.2 I Technical specifications

1.2.1 Device

	Hydroxinator® iQ 10	Hydroxinator® iQ 18	Hydroxinator® iQ 22	Hydroxinator® iQ 35
Nominal chlorine production	10 g/h	18 g/h	22 g/h	35 g/h
Nominal output current	2.8 A	3.6 A	5 A	7.2 A
Recommended mineral rate - min.	4 g/L - 3,3 g/L mini			
Power supply voltage	110 - 240V 50-60 Hz			
Electric power	200 W maximum			
Protection index	IP43			
Flow rate in the cell (minimum/ maximum)	5m³/h < 18m³/h			
Maximum pressure allowed in the cell	2.75 bars			
Operating water temperature	5°C < 40°C			

1.2.2 Optional pH Link or Dual Link modules

	pH Link	Dual Link
Power supply voltage	Extra-low voltage (connected to the control box)	
Peristaltic pump flow rate	1.2 L/h	
Maximum back pressure (injection)	1.5 bars	
pH and ORP sensor type	combined (pH = blue / ACL = red)	
pH correction	pH minus only (hydrochloric or sulphuric acid)	
pH minus dosage	Proportional cyclic	
pH sensor calibration	1 or 2 points (pH 4 and pH 7)	
ORP sensor tolerances	/	10 ppm maximum (shock chlorination)
ORP sensor calibration		1 point (470 mV)
Sensor cable length	3 metres	



2 Installing the device

2.1 I Installing the cell

- The cell must be installed on the piping after the filtering, after any measurement sensors, and after eventual any heating systems.

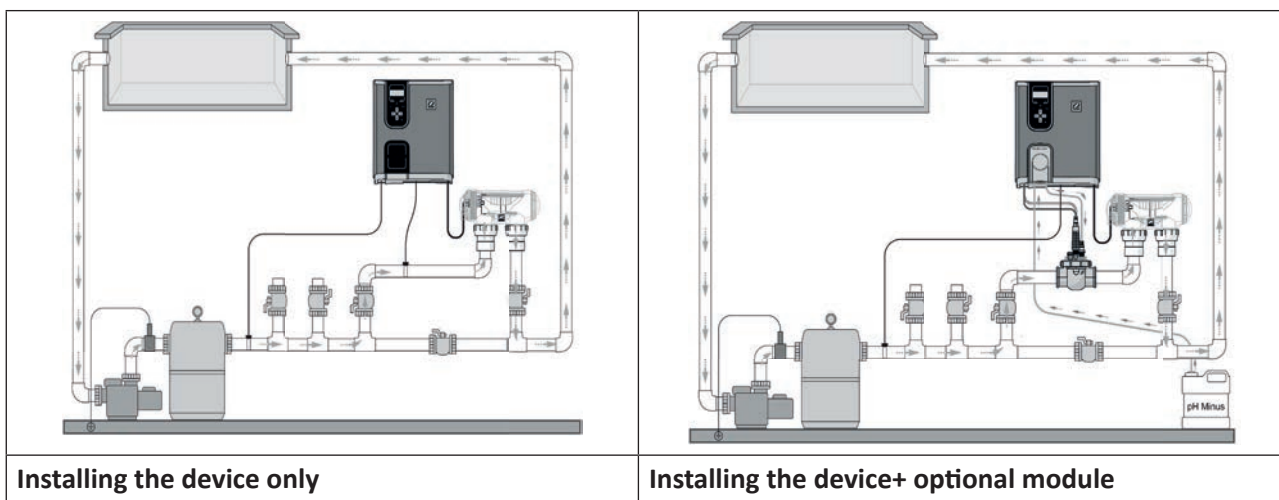

EN



- The cell must always be the last element placed on the pool return pipe (see diagram).
- It is always recommended to install the cell on a by-pass. This assembly is **MANDATORY** if the flow is in excess of 18 m³/hour to avoid head loss.
- If you installed the cell on a by-pass, it is recommended to fit a check valve downstream from the cell and not a manual valve, to avoid any risk of incorrect setting which could cause poor circulation in the cell.

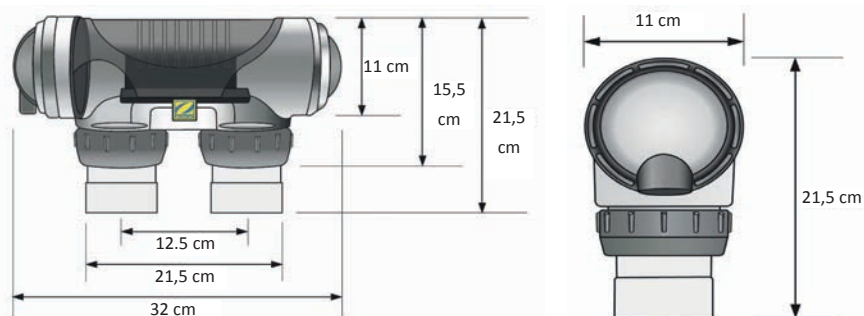

- Make sure that the cell is placed **HORIZONTALLY**. The water should flow from the electric connections towards the opposite side.
- Use the screw-on fittings to fix the cell to the pipes.
- For 63 mm pipes, glue them directly to the screw-on fittings. For 50 mm pipes, use glue-on PVC adapters of the corresponding diameter (grey models; the white models are for 1 1/2" UK pipes).
- Connect the cell power cord following the wire colour codes (red, black and blue connectors) and then refit the protective cap. The two red wires can be connected to one or the other red terminals on the electrode.

2.2 I Installing the temperature sensor

- The water temperature sensor displays the water temperature value on the appliance screen and manages chlorination according to the temperature. The sensor must measure the temperature of the water upstream of any possible heating system.
- The sensor is designed to be mounted on rigid 50 mm, 63 mm or 1 1/2" diameter PVC pipes. Do not install on any other type of pipe.
- Install the sensor either between the filter pump and the filter, or between the filter and any other downstream equipment, voir «2.1 I Installing the cell» :
 - Drill a hole in the pipe using a 9 mm (max. 10 mm) diameter drill bit, then deburr the hole,
 - Install the «O-ring» provided on the sensor body,
 - Secure the sensor using the stainless-steel clamping collar provided. Do not use excess strength.

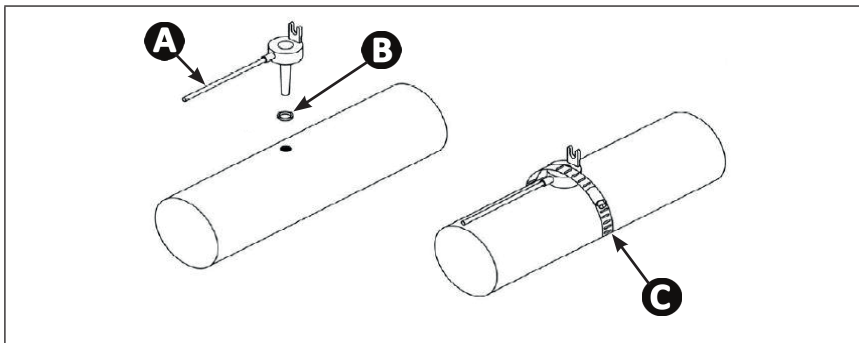

A: Sensor

B: O-ring

C: Stainless-steel clamping collar

2.3 I Installing the flow switch (device only without pH Link or Dual Link modules)



In cases where a pH Link or Dual Link module is used, the flow switch will be installed on the POD Kit, see "3.2 I Installing the flow switch on the POD kit"

- The flow switch and its fixture collar 50 mm diameter originally provided (diameter 63 mm available as a spare part) must be installed just before the cell and after any valve (1). Use the threaded adapter and Teflon tape supplied to install the flow switch on its fixture collar.
- Screw down the flow switch using the clamping nut only (tighten by hand!) (2).

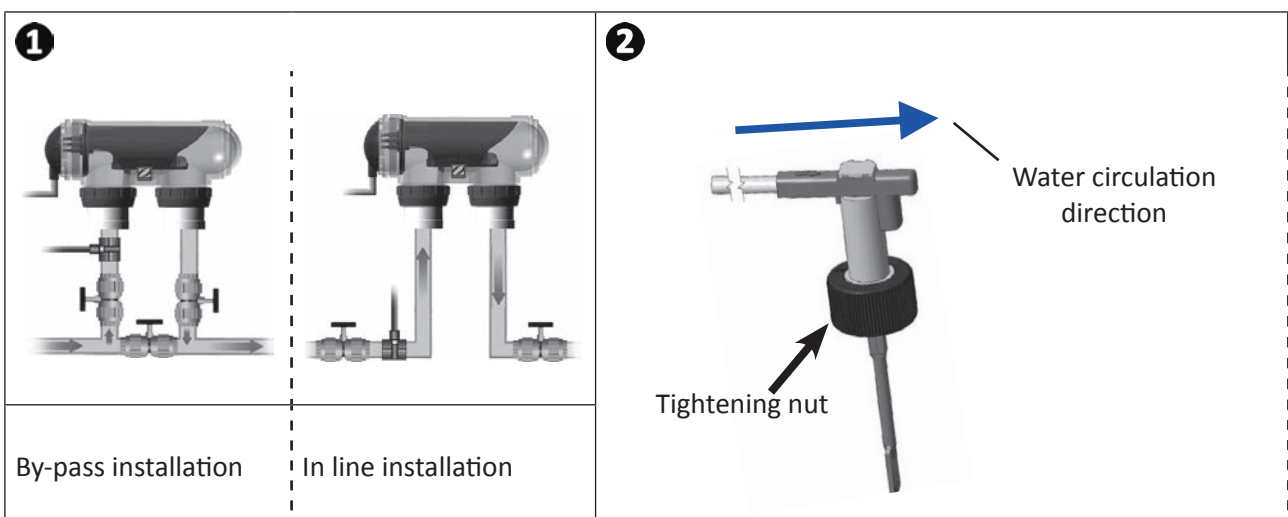

- Failure to comply with these instructions could lead to the destruction of the cell! The manufacturer cannot be held liable in this case.
- The flow switch has a direction for installation (arrow indicated on it showing the flow direction for the water). Make sure that it is correctly placed on its fixture collar so that it stops the device production when filtering is stopped.

2.4 I Installing the control box

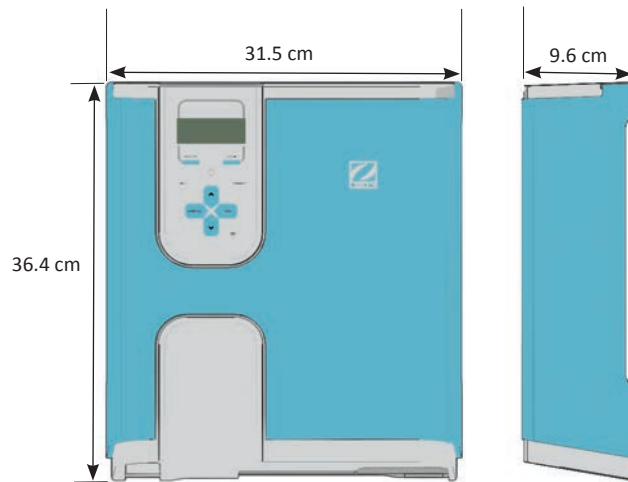

EN

- The control box must be installed in a dry ventilated equipment room protected against frost, with no pool maintenance chemicals or similar products stored nearby.
- The control box must be installed at least 3.5 metres from the outer edge of the pool. Always comply with all applicable installation codes and/or laws that may apply in the area of installation.
- It must not be installed more than 1.8 metres from the cell (maximum cable length).
- If the box is fixed to a post, a watertight panel must be fixed behind the control box (350x400 mm minimum):
 - Mount the metal hanging bracket shown below to the wall or a waterproof panel, using the screws and wall plugs provided, (illustration 1).
 - Fix the control box to the metal hanging bracket by moving 1 (downwards) and 2 (rightwards) in order to lock the box onto its bracket, (illustration 2).

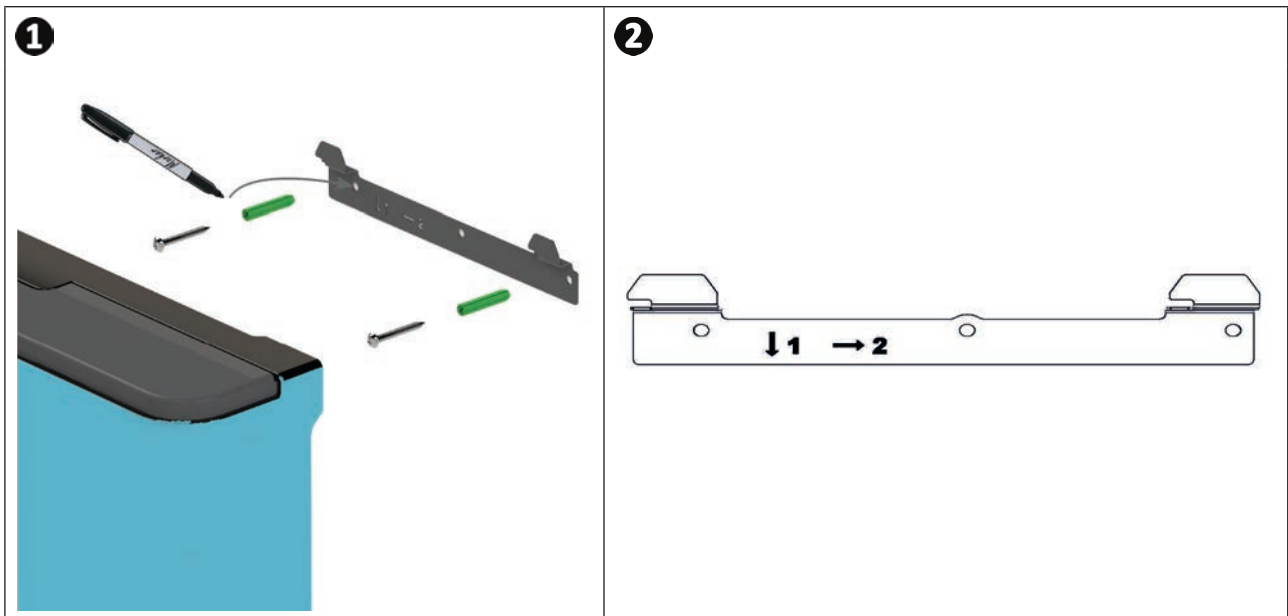

Use of Wi-Fi Direct Mode (depending on model): Take a smartphone (Settings / Wi-Fi menu) and make sure that the home's Wi-Fi network can be detected in order to select the best location for the control box. A Wi-Fi extender or CPL plugs with Wi-Fi hotspot (not supplied) may be necessary in certain specific cases.

➤ 2.5 I Electric connections

Many devices can be connected to the control box in order to control the pool equipment (filter pump, lighting, auxiliary systems, etc.).

The appliance must be permanently plugged in to the power supply (power supply protected by a 30 mA residual current circuit breaker).

2.5.1 Accessing the electrical connection terminal boards

- Make sure that the appliance is powered off.
- Remove the (snap-on) cosmetic cover over the control box, (illustration **1**).
- Remove the control box lower protection cover by unscrewing the two side screws (illustration **2**).

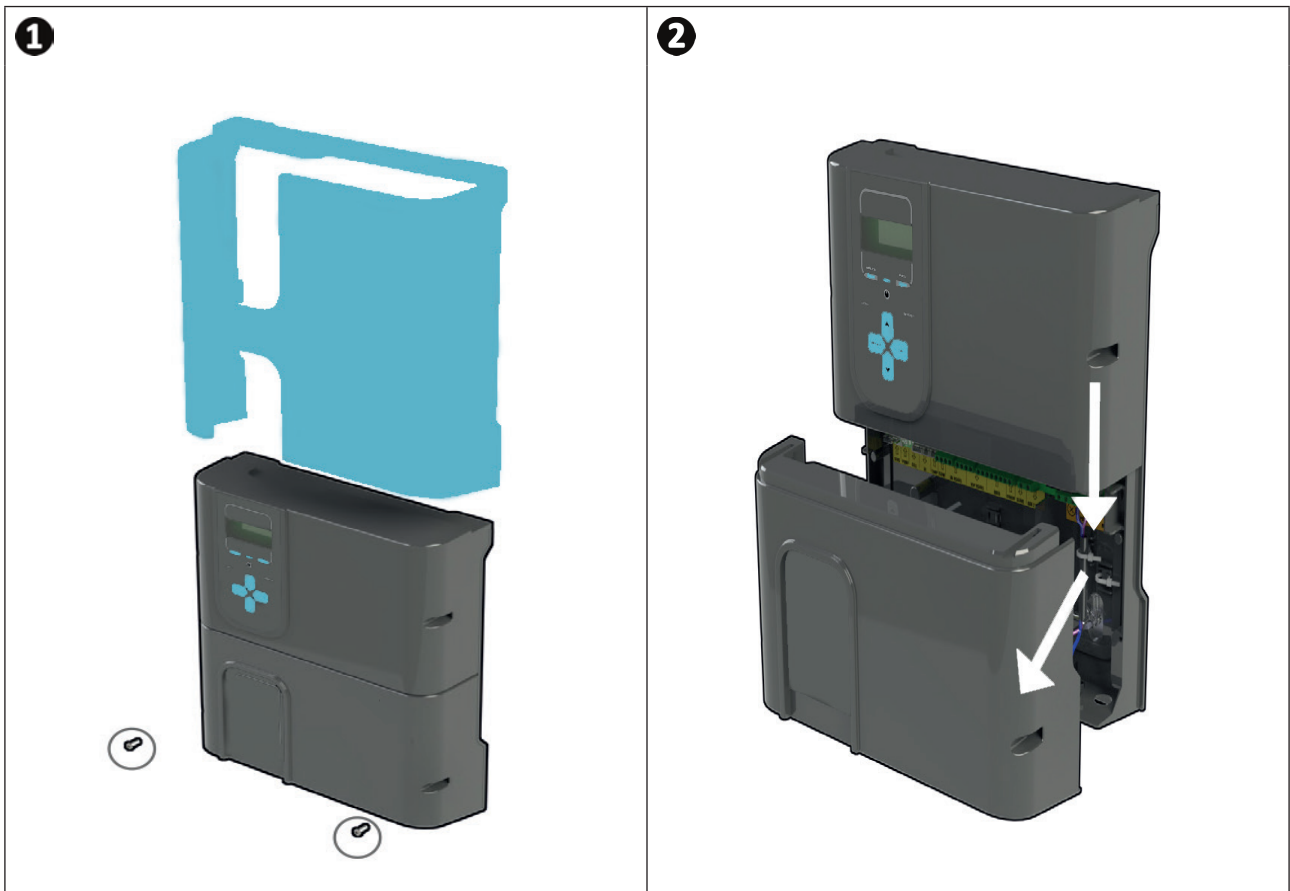

2.5.2 Identifying the functions to connect

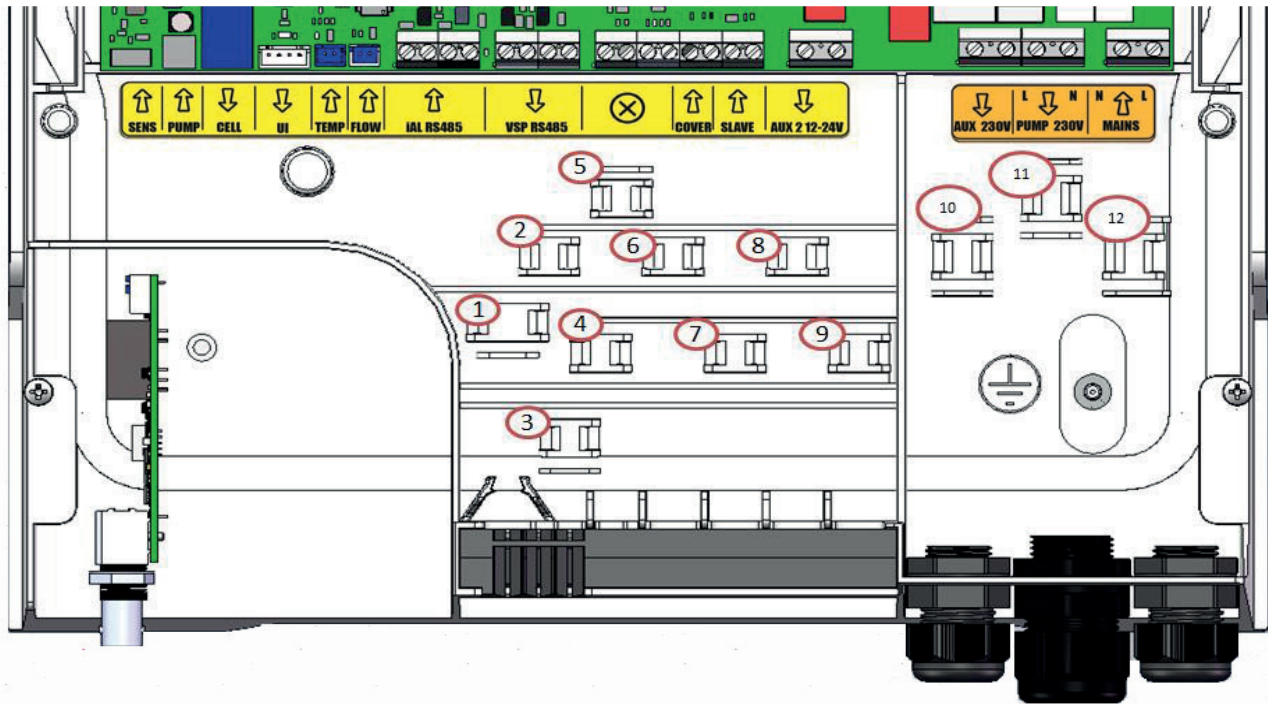

EN

Messages from the terminal board	Type	Cable clamp	Functions	Hydroxinator® iQ	Avec pH Link ou Dual Link
SENS	Input	-	Regulator board connection for pH Link & Dual Link modules	/	⚠
PUMP	Input	-	pH regulator pump connection for pH Link & Dual Link modules	/	⚠
CELL	Output	1	Connection for the electrolytic cell	✓	✓
UI	Output	-	Display connection	✓	✓
TEMP	Input	3	Connection for the temperature sensor	✓	✓
Flow	Input	2	Connection for the flow switch	✓	✓
iAL RS485	Input	4	<i>Function not used – do not wire</i>	/	/
VSP RS485	Output	5	Connection dedicated to controlling the Zodiac® variable-speed filter pump	+	+
⊗	/	-	<i>Function not used – do not wire</i>	/	/
COVER	Input	7	Connection for the roller shutter/cover for automatically managing the LOW function	+	+
SLAVE	Output	8	Connection for an external appliance managing the ON/OFF control for the chlorination system (automatic regulation, etc.).	+	/
AUX 2 12-24V	Output	9	Connection dedicated to the ON/OFF control of a low-voltage device This connection is not an appliance power supply: it manages the ON/OFF function only.	+	+
AUX 1 230 V	Output	10	Connection dedicated to the ON/OFF control of a high-voltage device. This connection is not an appliance power supply: it manages the ON/OFF function only.	+	+
PUMP 230V	Output	11	Connection dedicated to the power supply for the pool filter pump	+	+
MAINS	Input	12	110-240 VAC - 50/60 Hz mains power supply to the appliance	✓	✓

✓: Factory connected

⚠: Must be connected

+: Function to connect (optional)

2.5.3 Electrical connection steps

- Identify the functions to be connected and identify the location of the cable clamp, see «2.5.2 Identifying the functions to connect».
- Check that the cables used comply with the intended use and with the regulations in force.
- Identify the input for each desired function at the bottom of the control box:

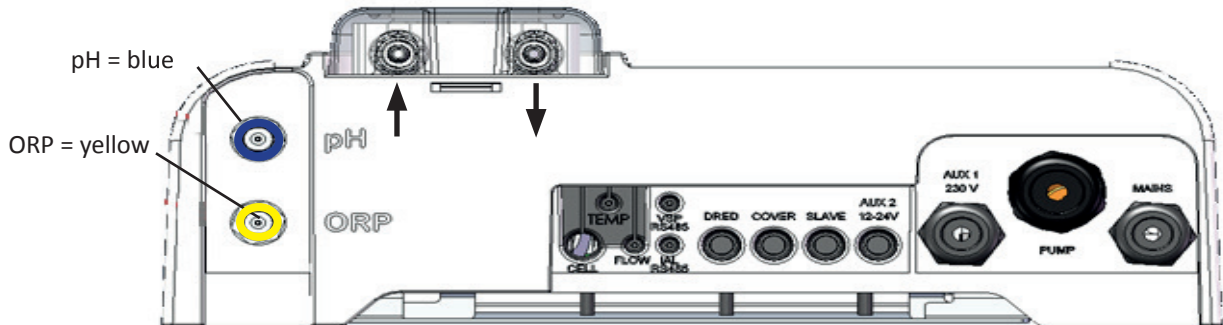

- Run the cable through its cable gland or pierce a hole in the PVC diaphragm (made of rubber) using a screwdriver of the right diameter.
- Identify the electrical connection terminal board for the desired function using the identification fields:

	Low-voltage part
	High-voltage part

- Fit the cable clamp (supplied) to physically hold the cable clamped against the chassis of the appliance. The cable clamp location is indicated, see «2.5.2 Identifying the functions to connect».
- If connected to the chlorinator, the filter pump (at single speed or variable speed) must be grounded using the dedicated grounding stud by crimping an appropriately-sized lug for the wire (not provided).

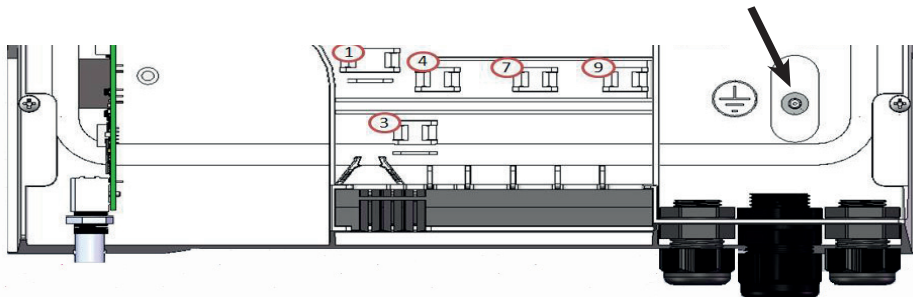

2.5.4 Connecting a Zodiac® variable speed filter pump

The Zodiac® variable speed filter pump must be connected in 2 places:

- Mains supply to the «PUMP 230 V» connector.
- RS485 cable (supplied with the pump) to the appliance's «VSP RS485» connector in the following order:

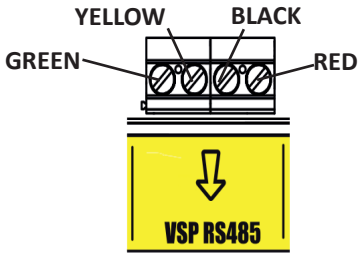
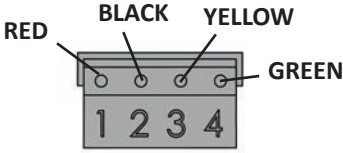
	
On the device	On the filter pump

EN

- Ensure the pump switches are in the correct position :

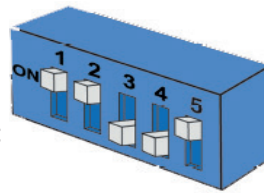

2.5.5 Reassembling the appliance

- Position the lower protection cover (or the pH Link/Dual Link module) onto the control box and screw down the two side screws (illustration ①).
- Snap the cosmetic cover over the control box, (illustration ② or ③ depending on the model).

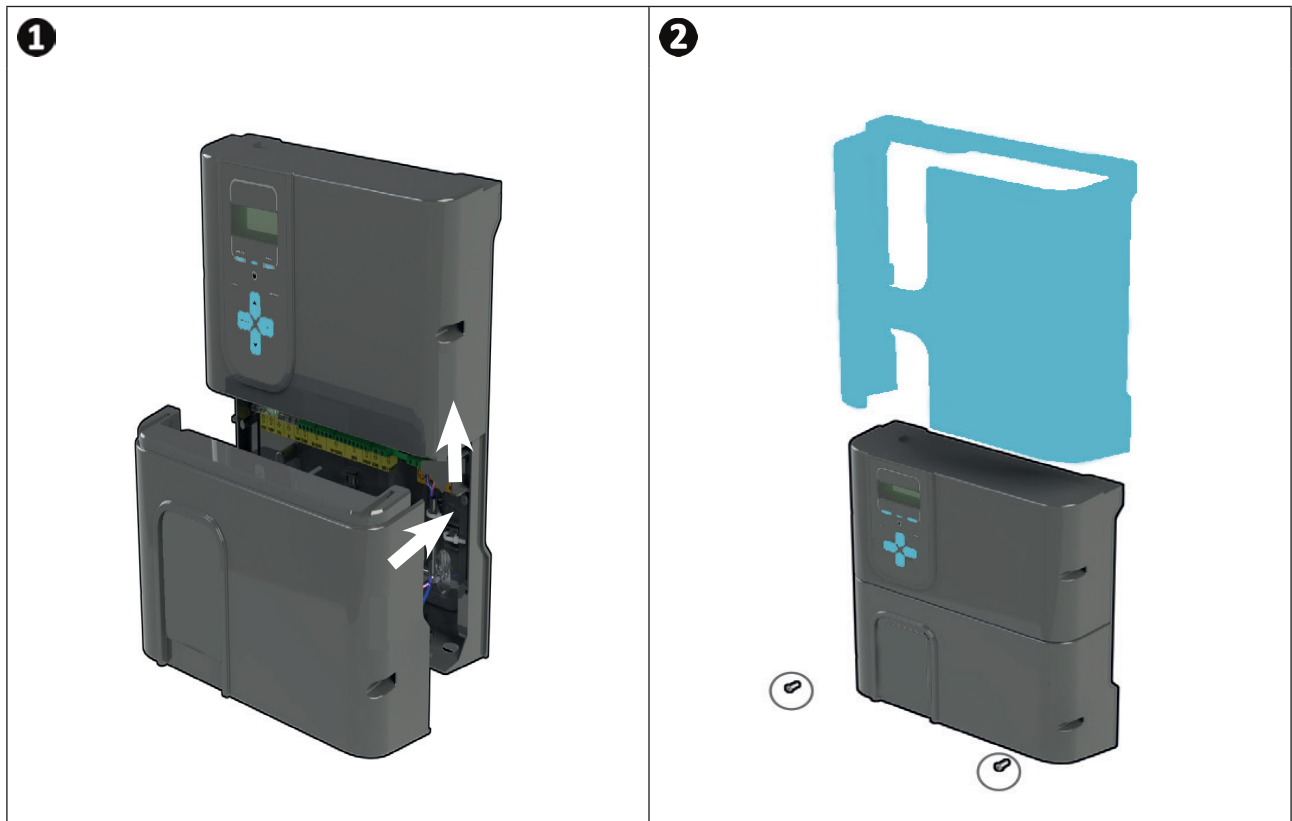

- In a pH Link or Dual Link module is installed, do not reconnect the electricity supply until the module, the POD kit and the pH minus injection pipe have been installed.



3 Installing a pH Link or Dual Link module

3.1 I Installing the POD kit

The POD Kit is a measuring chamber using patented Quick Fix® technology for installation on a rigid 50 mm PVC pipe (with supplied adapter) or 63 mm PVC pipe (without adapter). It contains the following components:

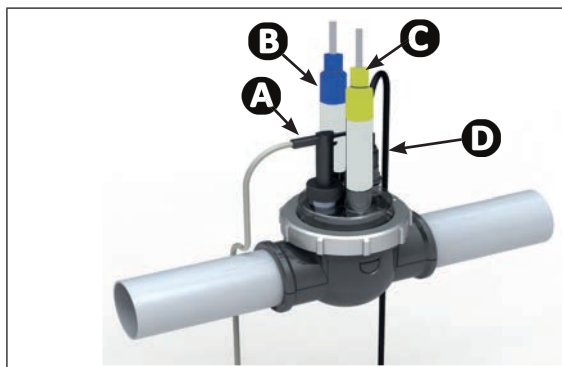

A: The flow switch

B: The pH sensor

C: The ORP sensor

D: pH minus injection

3.1.1 Recommended location



- The cell bypass valves must always be open.
- The sensor-holding POD kit must always be positioned on a horizontal pipe so that the sensors are vertical.
- The POD kit must be the first unit fitted after the pool filter.
- If the pool is fitted with an electric heater, the POD kit must be installed before it (to take readings on unheated water).
- We recommend positioning the POD kit more than 20 cm from an elbow in the pipe.
- The sensor cables must not be positioned near high voltage mains electricity cables.

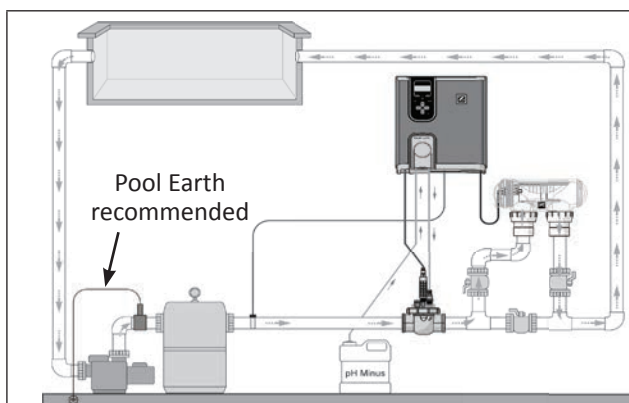

In line installation

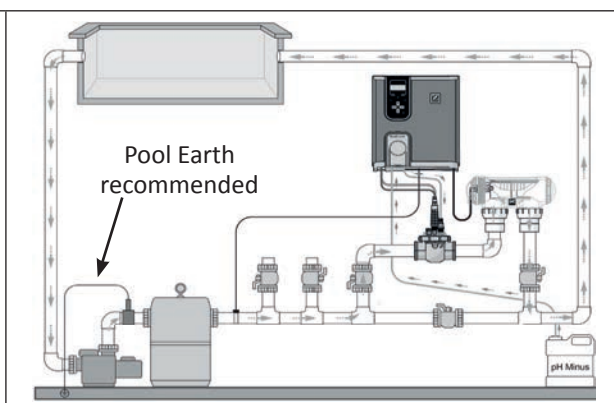

By-pass installation

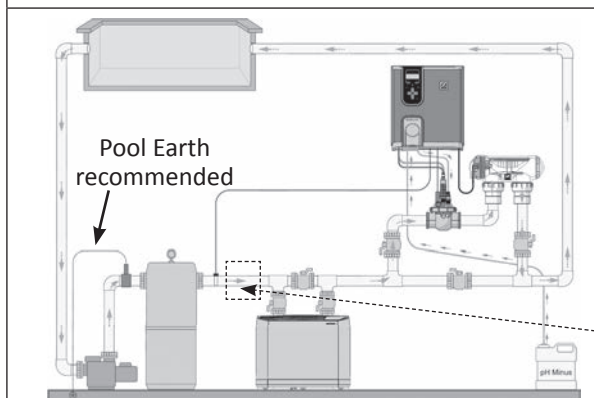

Installation with heating system



- If an electric heater is installed (and not a heat pump), put the POD Kit in front of it (to measure unheated water). In this case, the flow rate detector must be placed in the by-pass on the fixture collar.

3.1.2 Preparing the hose

- Identify a suitable length (minimum 30 cm, without an elbow) of straight pipe.
- Disassemble the POD kit to retrieve the EU (DN50 mm) type adapter provided with two perforations, see illustration ①.
- For a DN50 mm pipe use the EU DN50 mm pipe adaptor (otherwise use the DN63 mm lower clamp). Position it on the pipe in a recommended location, see “3.1.1 Recommended location”. Use a centre-punch or marker pen to mark the position of the holes to be made in the pipe, see illustration ②.
- Using the hole saw supplied, cut the two feed holes for the POD kit, see illustration ③.
- Ensure that the edges of the holes are smooth and deburred, see illustration ④.

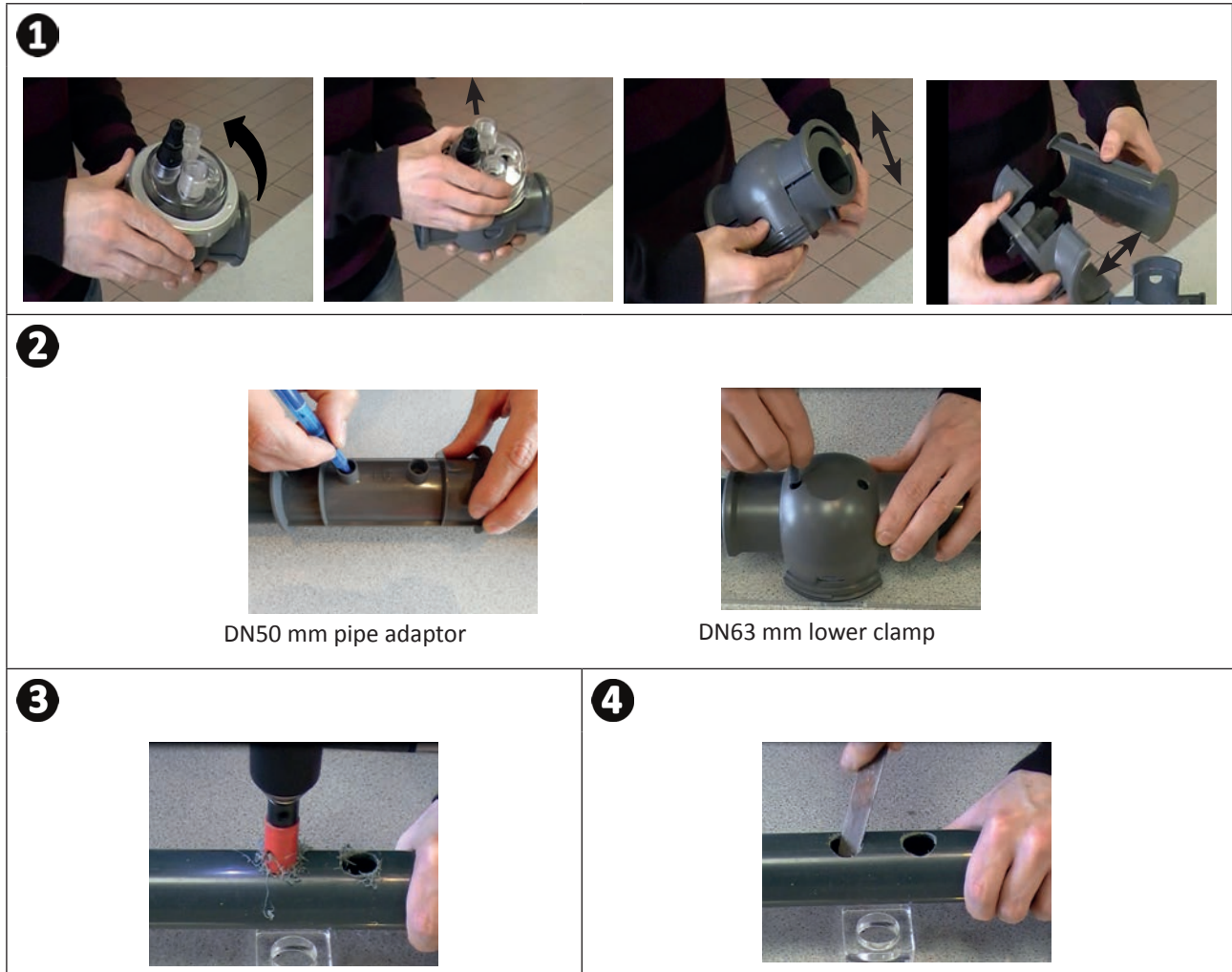

3.1.3 Installing the POD kit on the pipe

- Click the 2 parts of the POD kit together around the pipe. For a 50 mm diameter pipe, use the adapter marked 'EU'. Do not use this adapter for a 63 mm diameter pipe, **see illustration 1**.
- Install the lower and upper pipe shells from the POD kit onto the pipe so that they match up with the location of the holes and the direction of the water flow (follow the direction shown by the arrows), **see illustration 2**.
- Position the upper part with its various components in the direction shown by the fool proofing. Align the dot **C** on the clamping ring with the arrow **D** on the lower pipe shell and tighten down the clamping ring (by hand only!), **see illustration 3**.
- To see whether the tightening is correct, check that the clamping ring is level, **see illustration 4**.

1

Pipe adapter, 50 mm diameter ("EU" markings)

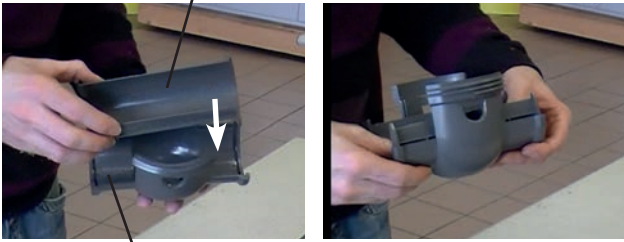

Lower clamp, 63 mm diameter

2



INLET

OUTLET

Water circulation direction

3

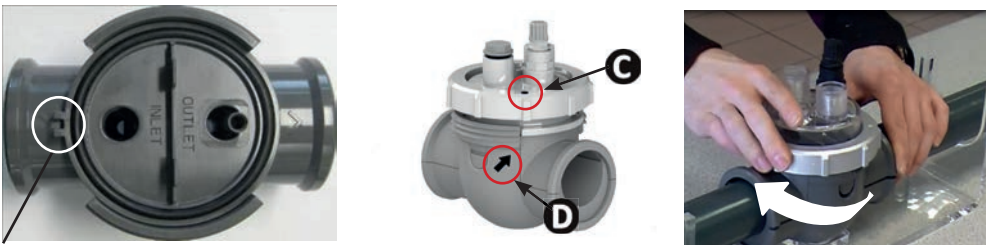

Fool proofing

4



▶ 3.2 I Installing the flow switch on the POD kit

- Take the flow switch provided with the chlorinator control box.
- Place it inside the housing provided for this purpose on the POD Kit and screw it down.
- Screw it down using the clamping nut only (by hand only!).



- The arrow showing the water circulation direction on the top of the flow switch must be perfectly aligned with the pipe that the POD kit is mounted on.

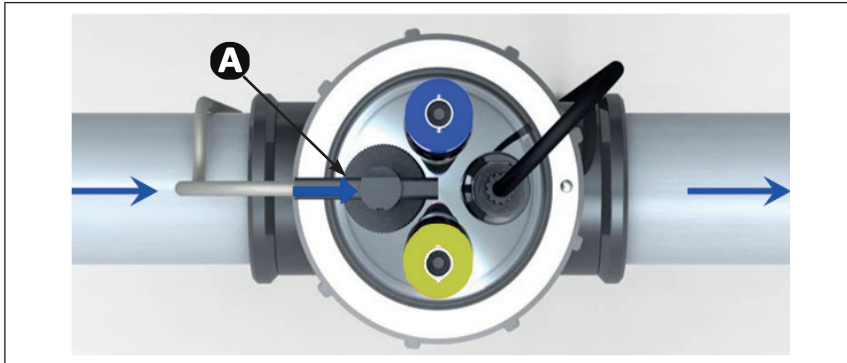

A: The flow switch

➤ 3.3 I Installing the sensors on the POD kit

- Screw down the one or more sensor holders onto the POD kit, see illustration ①.
- Carefully unscrew the protection tube from the sensor, see illustration ②. Retain the protection tube for use when the sensor is stored during the winter.
- Rinse the end of the sensor with tap water and shake off excess water, see illustration ③.



- Never wipe the sensor using a cloth or paper tissue, as this may damage it!
- A badly-installed sensor may give false readings and cause inappropriate operation of the appliance. Neither the manufacturer nor the appliance shall be liable in this event.

- Screw the sensor into the sensor holder, holding the BLUE or YELLOW connector in one hand and the black connector in the other to avoid tangling the cable, see illustration ④.
- Once the sensor is installed on the POD kit, it can be connected to the BNC connector (BLUE = pH; YELLOW = ORP) on the pH Link or Dual Link module, see “2.5.3 Electrical connection steps”, see illustration ⑤.
- Then the sensor is ready for calibration, see “5.3 I Calibrating the sensors (if an optional pH Link or Dual Link module is installed)”

①



②



③



④

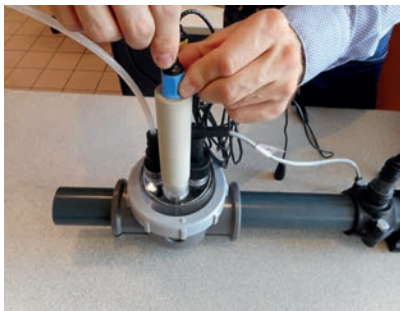

⑤



3.4 I Installing the pH minus injection and suction pipes



- When handling chemical products, always use appropriate safety equipment (safety glasses, gloves and jacket).



The peristaltic pump rotates in the clockwise direction. The acid (pH minus) is therefore sucked into the left side of the pump and injected into the tank from the right side. The pump flow direction can be identified on the pH Link or Dual Link module by looking at the two arrows provided.

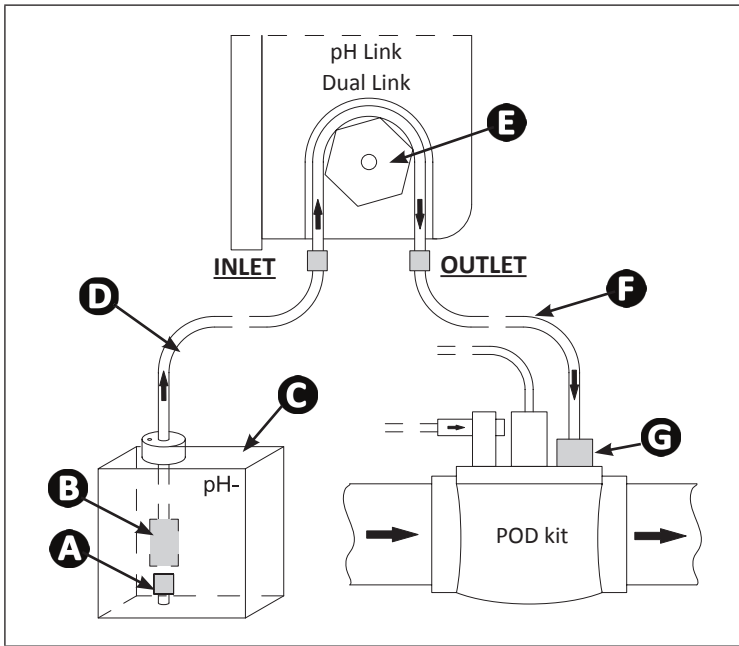

- A**: Locking nozzle
- B**: Ceramic weight
- C**: pH minus container
- D**: Suction pipe
- E**: Peristaltic pump
- F**: Injection pipe
- G**: Injection check valve

EN

3.4.1 Installing the pH minus injection line

- Remove the protection cover from the peristaltic pump, **see illustration 1**.
- Cut a suitable length of pipe from the coil supplied to connect the peristaltic pump to the injection check valve located on the POD Kit.
- Unscrew the connector cap and attach the pipe to the connector on the outlet from the peristaltic pump, **see illustration 2**.
- Attach the other end of the pipe to the injection check valve on the POD Kit, **see illustration 3**.



3.4.2 Installing the pH minus suction pipe

- Cut a suitable length of pipe from the coil supplied to connect the container of pH minus to the peristaltic pump.
- Unscrew the connection cap and attach the pipe to the connector on the inlet to the peristaltic pump, **see illustration 1**. Screw the connection cap.
- Place the protection cover from the peristaltic pump.
- Drill two holes in the cap on the pH minus container, **see illustration 2**:
 - One hole to match the diameter of the pipe used to suck the product up.
 - A second smaller hole to stop the container from deforming if a vacuum is created.
- Pass the free end of the pipe through the hole drilled into the cap and put the ceramic counterweight and threaded locking nozzle on the end, **see illustration 3**.
- Ensure that ALL connections are correct and watertight before operating the appliance.

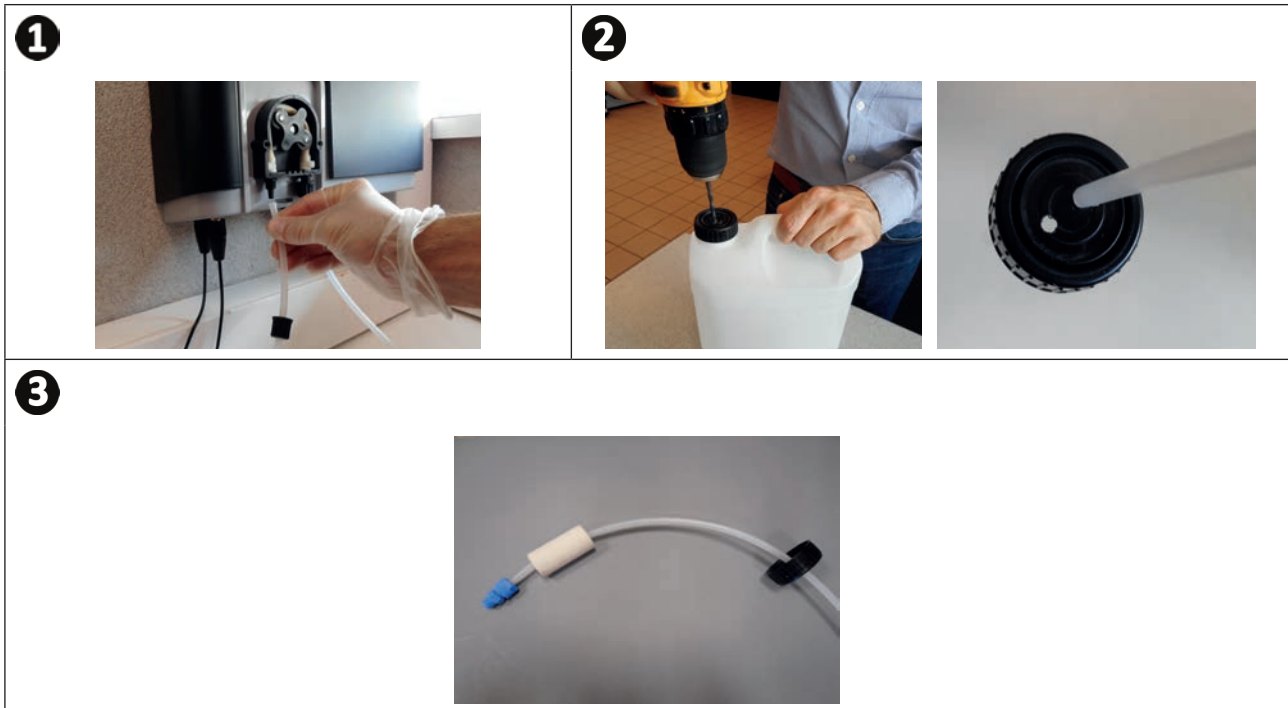

Do not place the pH minus container directly under the electrical appliances in the technical premises to prevent any risk of corrosion due to potential acid vapours.



4 Pool preparation

4.1 I Filtration and filter medium

The exclusive magnesium-based treatment system is designed to operate at optimum efficiency when used with a properly designed and sized filtration system, and with the Zodiac® Crystal Clear glass filtration medium (not sand).

Filter filling procedure:

- Pour clean water into the filter's tank to cover the side diffusers and start lowering the filter medium **A**.
- Use a plastic bag to cover the filter's upper diffuser when filling it (to prevent any filter medium from getting into it).
- Then pour the filter medium according to the following ratio:
 - Approximately 1/4 to 1/3 of the total weight required with "large" Zodiac® Crystal Clear glass medium to cover the side diffusers **B**.
 - Approximately 2/3 to 3/4 of the total weight required with "fine" Zodiac® Crystal Clear glass medium **C**.

EN

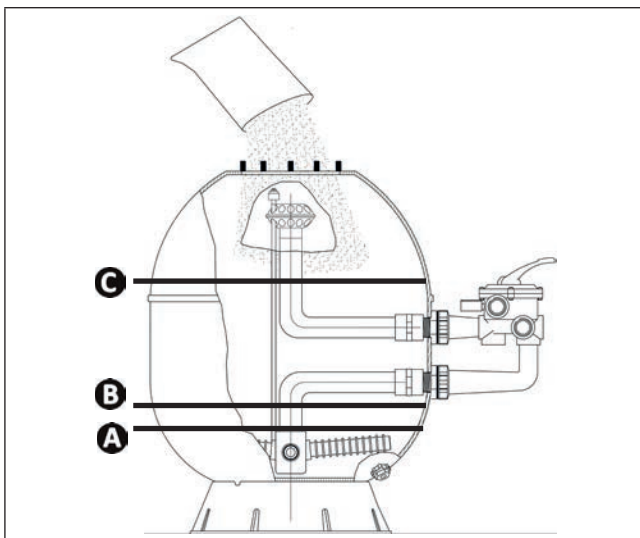

- C**: "Fine" Zodiac® Crystal Clear level
- B**: "Large" Zodiac® Crystal Clear level
- A**: Water level



Tip: connecting the filter and the filtration pump

- Refer to the filter and pump installation and user manuals for more details. Consult your Zodiac® distributor if necessary.

4.2 I Water balance

The water used must originate from a supply network compliant with Directive 98/83/EC on the quality of water intended for human consumption. To achieve optimum water treatment, be sure to measure and adjust the values in line with the following recommendations:

4.2.1 Seasonal «restart» analysis

- **Stabiliser (cyanuric acid) (<30 mg/L, ppm):** the stabiliser protects the chlorine against the destructive action of U.V light from the sun. Excessive stabiliser levels may block chlorine's disinfecting action and cause the water to go bad.
- **Metals (Cu, Fe, Mn) (± 0 mg/L, ppm):** metals affect the metal parts of the pool (corrosion phenomena) ou peuvent être à l'origine de taches indélébiles.

4.2.2 Monthly analysis

- **TH (10-30°f) or (100 - 300 mg/L CaCO₃, ppm) :** TH measures the calcium hardness (amount of calcium). This value may vary significantly depending on location.
- **TAC (8-15°f) or (80 -150 mg/L CaCO₃, ppm) :** TAC measures the total alkalinity of the water. This value is used to stabilize the pH. It is important to adjust TAC before pH.

4.2.3 Weekly analysis

- **pH (7.0 - 7.4):** the pH level measures the acidity or basicity of the water. A pH level between 7.0 and 7.4 will preserve the pool equipment and ensure effective disinfection. **Below is the Taylor's watergram method**
- **to adjust the pH value:**

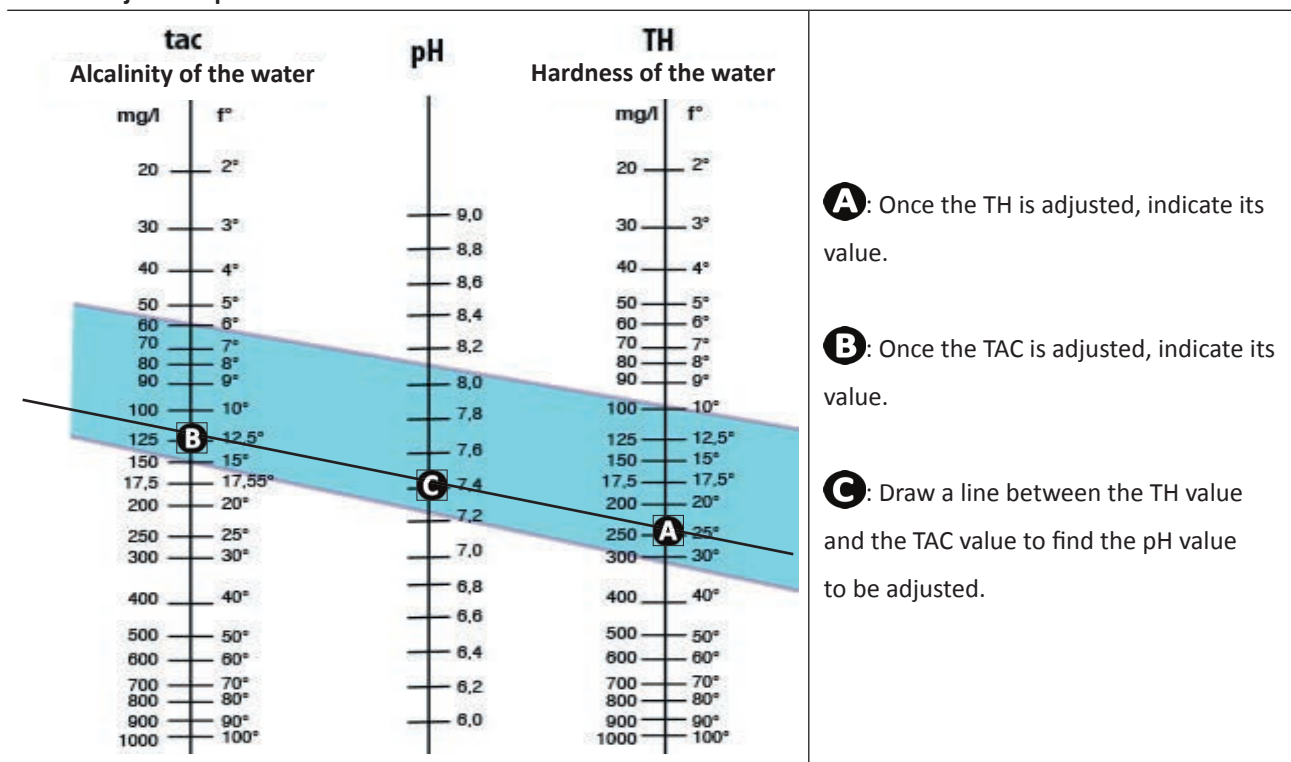

Taylor's watergram

- **Free chlorine (0.5 - 2 mg/L or ppm):** this amount of free chlorine ensures that the water is disinfected and disinfecting.



Contact your dealer to determine the type of corrective product or automatic regulating device to use to adjust the values.

4.3 I Adding minerals



- It is important to add the minerals according to the procedure below before starting the device.
- The minerals must be added to a pool with fresh water (tap water only, well water prohibited). For an installation in an existing pool, the pool must be drained first and filled with fresh water (follow the pool manufacturer's recommendations for drainage).
- The filtration must be running when the minerals are added.
- Always pour in full bags, do not keep any open mineral bags (the minerals are damaged by dampness).

The quantity of Magnesium minerals necessary for the system to operate correctly must be 4 g/L (= 4 kg/m³, 4000 ppm or 0.4 %), for this you must add 5 kg/m³ (as the minerals contain a little water).

EN

Pool volume (m ³)	20	30	40	45	50	55	60	65	70	80	90
Number of kg to be added	100	150	200	225	250	275	300	325	350	400	450

- Add the minerals by pouring the bags evenly and directly around the edges of the pool.
- Start up the filtration and the device.
- Leave the filtration in forced operation for 24 hours, then return to normal daily operation.

==> Activating the treatment

This exclusive magnesium-based treatment system is specific; therefore, you must understand the following steps.

- Once they are poured into the pool water, the minerals will turn it slightly cloudy and some harmless foam may also appear on the surface of the water. This is perfectly normal and shows the initial hydroxination action of the magnesium present in the minerals.
- Approximately 48 hours after the minerals are added, the water will become perfectly clear.
- You may need to perform a short filter backwash to remove any debris from the equipment installation. Refer to the filter's pressure indicator and its user manual.



Tip: incorporating minerals

- This slightly cloudy appearance with some harmless foam on the surface may last for a few days depending on the type of pool and the daily filtration cycles used (ideally you should run the filtration for at least 12 hours per day during this activation phase).
- To facilitate the activation of the treatment, it is preferable that you do not swim in the pool during this short period.
- The cleaning robots may also have trouble climbing the pool walls. It is best to use them in "bottom only" mode if they have this function. They will regain their normal operation when the water is clear again.



5 Use

5.1 | User interface



- Before starting the appliance's chlorination function, make sure that all of the minerals added to the pool has dissolved fully.

SALTS

Blue indicator on:

Water conductivity too low (lack of minerals, water too cold, worn cell, etc.)

Activate/Disable Low mode manually :

Reduction in chlorine production from 0% to 30% in 10% intervals (adjustable from the dedicated MENU).

"LOW MODE ON" message displayed.

User menu

Parameter setting.

Arrows :

- Browse a menu
- Increase or reduce a setting value
- Lock/Unlock the user interface (Simultaneously press both buttons for four seconds).

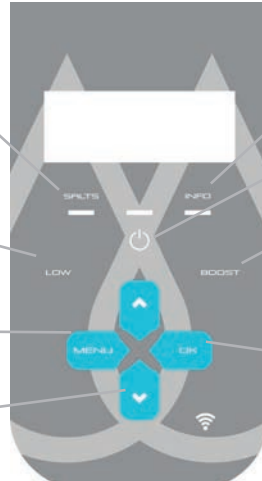

INFO

Blue indicator on or blinking:

See information or action to perform on-screen.

On (short press) / **Off** (press and hold) / **Standby** (short press)

Activate BOOST mode :

Chlorine production at 100% for a cumulative 24 hours. "BOOST ON" message displayed on the screen with the time remaining.

Bouton :

- Confirm the highlighted selection
- Clear an error message that requires operator action (press for four seconds)



Enable the Wi-Fi Direct mode to connect to the iAquaLink™ application (depending on model)

(Press both buttons simultaneously for four seconds).

The  indicator lights up.

5.2 | Settings required prior to use







5.2.1 Starting the appliance

- Press  to switch the appliance on.
- On start-up, the following appliance information is displayed:

```

HYDROXINATOR
V X . X X      X X / X X
  
```

5.2.2 Setting the language

- The first time the system is started, the list of languages is displayed. Simply select the language required with the   . Confirm the selection by pressing  .
- To modify the language later, press  and scroll using the   buttons.
- Confirm the selection by pressing  .

```

      MENU
- FILTER PUMP
- AUX / LIGHTS
- PROGRAMMING
- PH SETUP
- ORP SETUP
- LOW / COVER MODE
- SLAVE MODE
- REVERSING TIME
- HELP MENU
- LANGUAGE
  
```

```

SELECT LANGUAGE
- ENGLISH
- FRANCAIS
- ESPANOL
- ITALIANO
- DEUTSCH
- NEDERLANDS
- PORTUGUES
- CESTINA
- MAGYAR
- SVENSKA
- SLOVENSKY
  
```

5.2.3 Setting the time

Setting the time is essential for programming the filtration time using "TIMERS" and the chlorination time using "HYDROX". The time is set the first time the appliance is used. Follow the indications below if you need to make any modifications to the time displayed:

- To change the time, press **MENU** and scroll using the **▲** **▼** buttons.
- Confirm the selection by pressing **OK**.

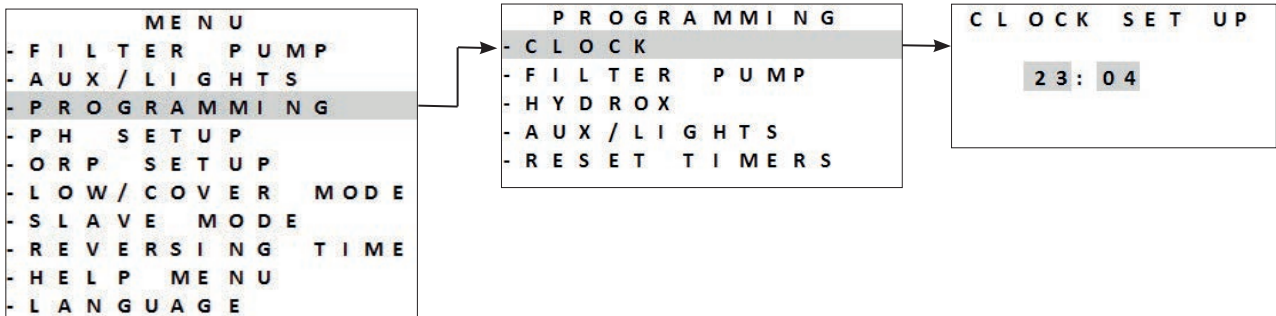

- Press **MENU** to exit.

5.2.4 Selecting the filter pump

The filter pump can be directly connected to and managed by the device.

- To do this, the filter pump must first be electrically connected, see **“2.5.2 Identifying the functions to connect”**.
- To declare the presence of the filter pump, press **MENU**. Browse the menu using the **▲** **▼** buttons. Press **OK** to confirm.
- Select a **"Single speed"** or **"Variable speed"** filter pump and confirm that it is connected:

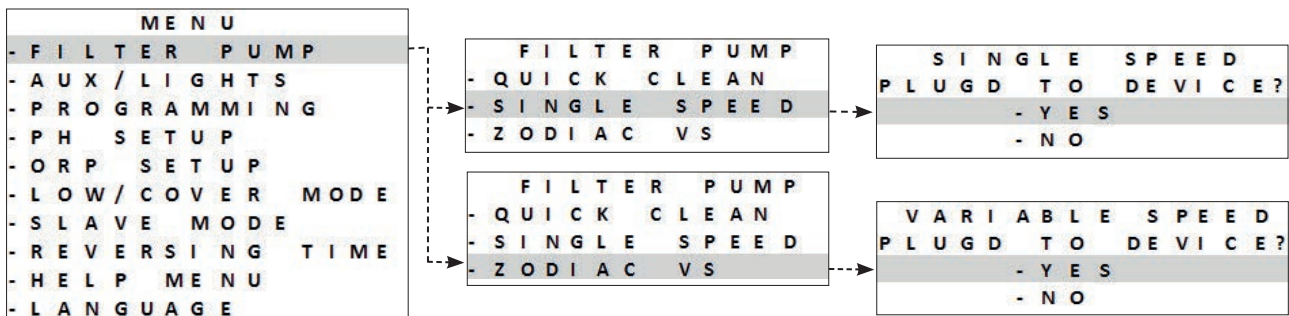

- Continue the setup sequence by programming the filtration time using "TIMERS", see **“5.2.5 Programming the filtration time using “TIMERS””**

5.2.5 Programming the filtration time using "TIMERS"

The timers are used to define the length of time for the filter pump to operate, and the length of time for device to produce chlorine. This offers the user the advantage of running their variable speed pump longer at lower flow rates, without having the chlorinator producing the whole time.







In order to complete the timer program, it is necessary to enter and validate both ON and OFF times. If no timer is set, the filtration and / or chlorination will run continuously.

The filtration operating times must be sufficient to correctly treat the water.

Programming examples

- Filtration time (TIMER) in pool season for a water temperature at 26°
==> **26/2 = hours of filtration per day**
- Filtration time (HYDROX) outside pool season (wintering active) for a water temperature at 16°
==> **16/2 = 8 hours of filtration per day**

==> Single-speed filter pump

- Two operating periods can be programmed, **TIMER 1** and **TIMER 2**.
- Select the **TIMER** to program using the   buttons. Press  to confirm.
- Set the time when the filter pump starts "**ON**" and the time when the filter pump stops "**OFF**" using the   buttons. Press  to confirm.

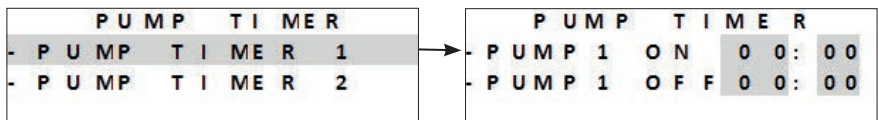

- Press  to exit.
- When filtering times are programmed, a letter "**P**" is displayed on-screen:

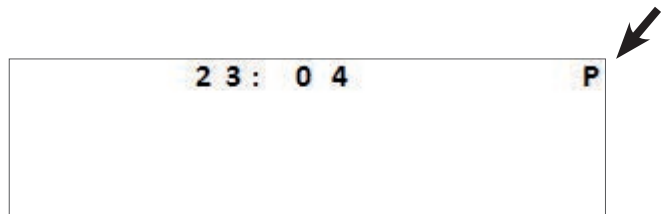







Manual activation of the device (pressing ) takes priority over the timer. If no filter pump is connected, the device will only start chlorination.

If a single speed filter pump has been connected the filter pump will start along with chlorination.

If a variable speed pump filter pump has been connected the filtration pump will run along with the chlorination at it's set RPM 1 speed. All programs will still be valid and will resume normal operation the next cycle.

==> Zodiac® Variable-speed filter pump

- It is possible to program filtering times using the "TIMERS" function for each speed available.
- Select a speed using the   buttons. Press  to confirm.
- Set the time when the filter pump starts "ON" and the time when the filter pump stops "OFF" using the   buttons. Press  to confirm.

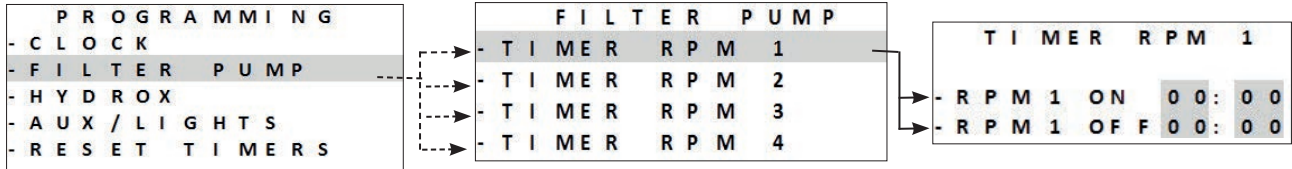

EN

Programming examples (when running at lower speeds)

- Filtering time (TIMER) during the peak pool season = 12 to 14 hours a day
- Chlorination time (HYDROX) during the peak pool season = 8 to 10 hours a day
- Filtering time (TIMER) outside of the peak pool season (active winterising) = 3 to 4 hours a day
- Chlorination time (HYDROX) outside of the peak pool season (active winterising) = 2 to 3 hours a day

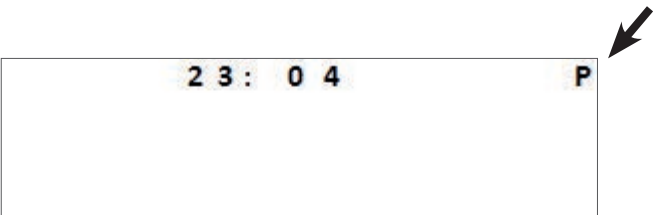

- Press  to exit.
- When filtering times are programmed, a letter "P" is displayed on-screen:



- Variable speed filtration timers 1 and 2 are linked to the device programs, see "5.2.6 Programming the chlorination time using "HYDROX"".

5.2.6 Programming the chlorination time using "HYDROX"

If a filtration program has been set, the chlorination program will be identical to the filtration program(s) by default. They can be changed, however the chlorination program(s) cannot be activated outside of the filtration Program(s) for safety reasons.

- Press **MENU** and scroll using the   buttons. Confirm the selection by pressing **OK**.
- Select "HYDROX TIMER 1" or "HYDROX TIMER 2":

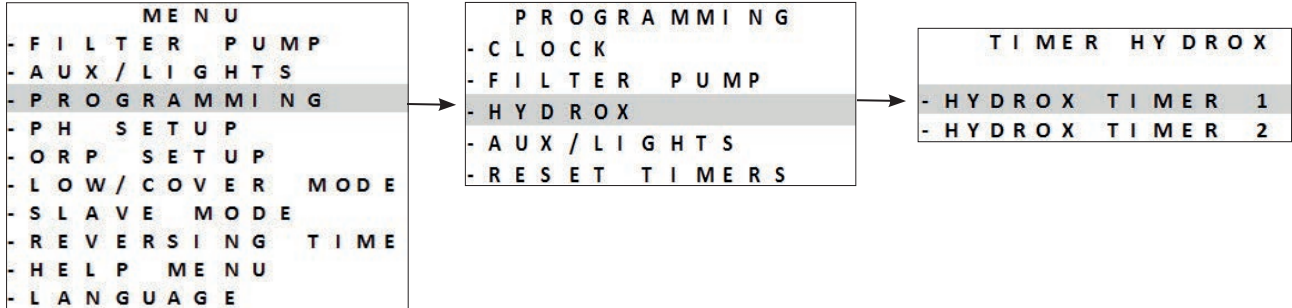

- Set when chlorination starts "ON" and stops "OFF" using the   buttons.
- Confirm the selection by pressing **OK**.

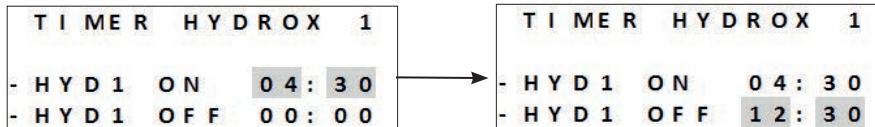

 The chlorination time must be equal or shorter than the filtration time. The device will not accept a chlorination timer longer than or outside the programmed filtration time.

- Press **MENU** to exit.
- When the chlorination times have been programmed and confirmed, a letter "T" is displayed on-screen:

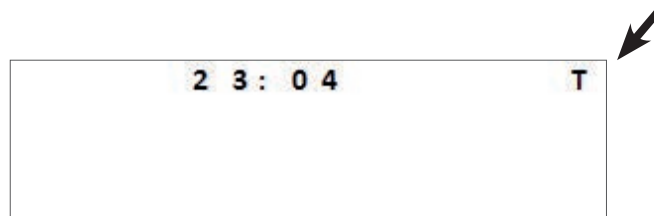

- When the chlorination and filtering times have been programmed and confirmed, a letter "P" is displayed on-screen:

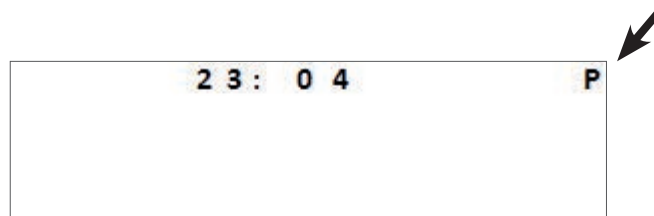

5.2.7 Selecting an additional auxiliary device



The device is capable of controlling two devices in addition to the filter pump. It can for example control monochrome or multicolour Zodiac® lights. In all cases, the equipment must be connected to the device using the appropriate auxiliary line:

- **AUX 2** = for equipment supplied with **low voltage supply (12/24 V)**
- **AUX 1** = for equipment supplied with **high voltage supply (230 V)**



- Unlike the filtration pump, the appliance does not provide the electricity supply to these two items of external equipment (AUX1 and AU2). You must ensure that these appliances are connected correctly according to current legislation.

EN

- Press **MENU** and browse the menu using the   buttons.

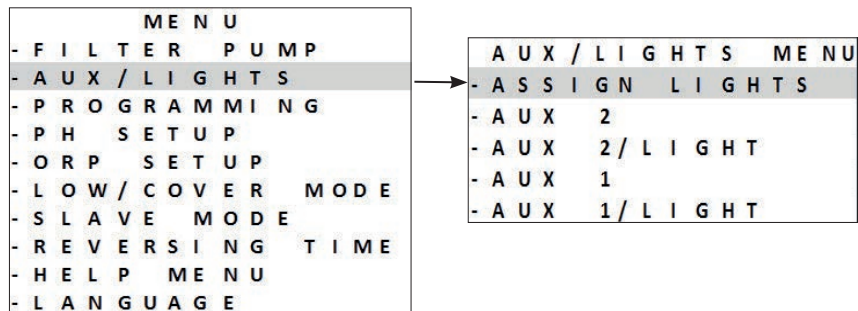

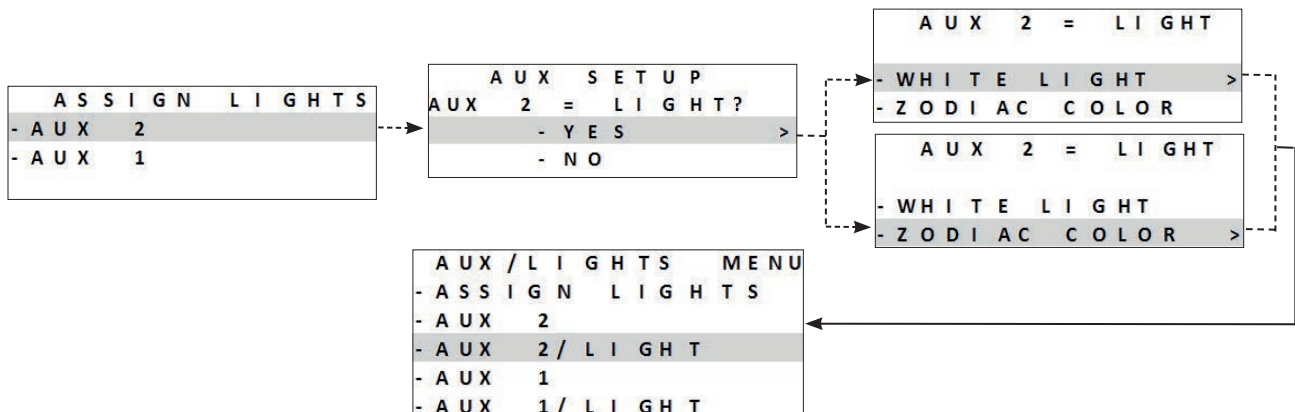

- Possible piloting of 2 auxiliaries with the option of setting one as lighting:



- Press **OK** to confirm.
- Press **MENU** to exit.

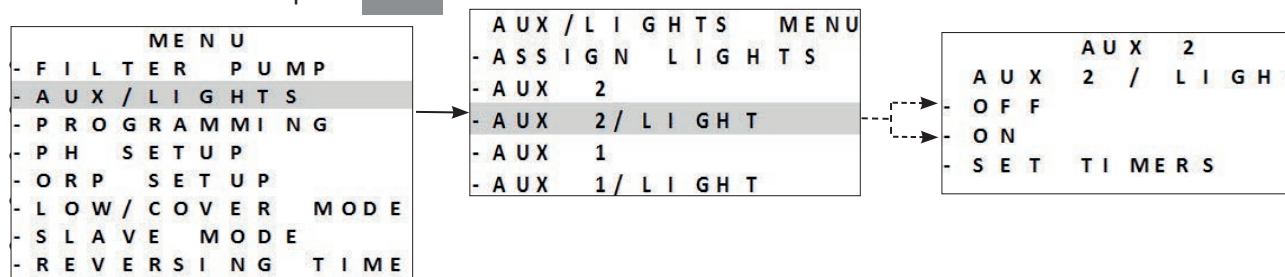

==> Monochrome lighting

- Press **MENU** and browse the menu using the   buttons.
- Select a function and press **OK** to confirm.



- Press **MENU** to exit.

==> Zodiac® multicolour lighting

- Press **MENU** and browse the menu using the   buttons.
- Select a function or a colour and press **OK** to confirm.

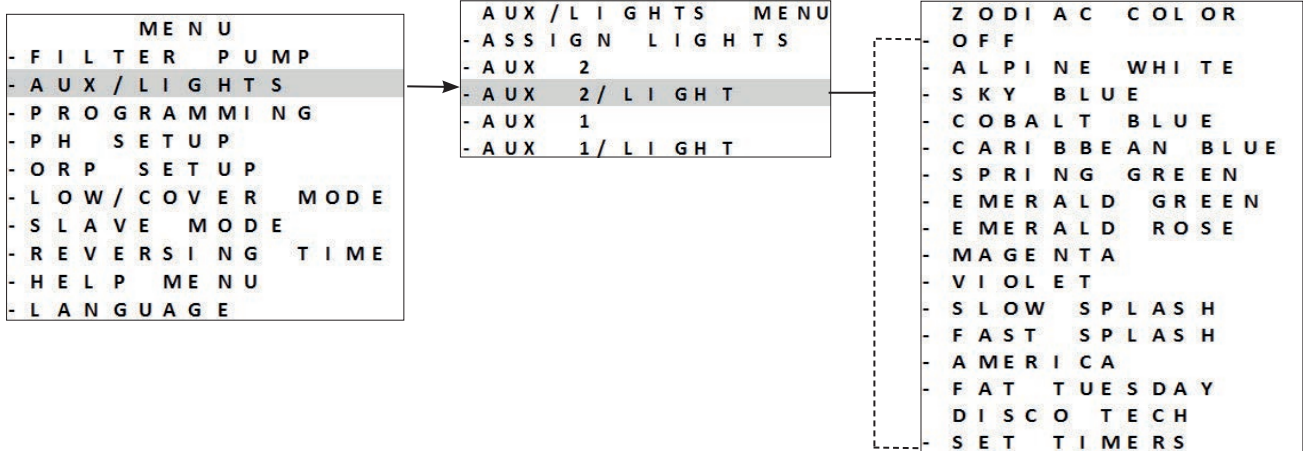



- Press **MENU** to exit.



For multicolour lighting of another brand, only the «ON/OFF» management is possible.

5.2.8 Clearing programming settings

- Press **MENU** and browse the menu using the   buttons.
- Press **OK** to confirm.
- Program settings will be reset to 00:00.

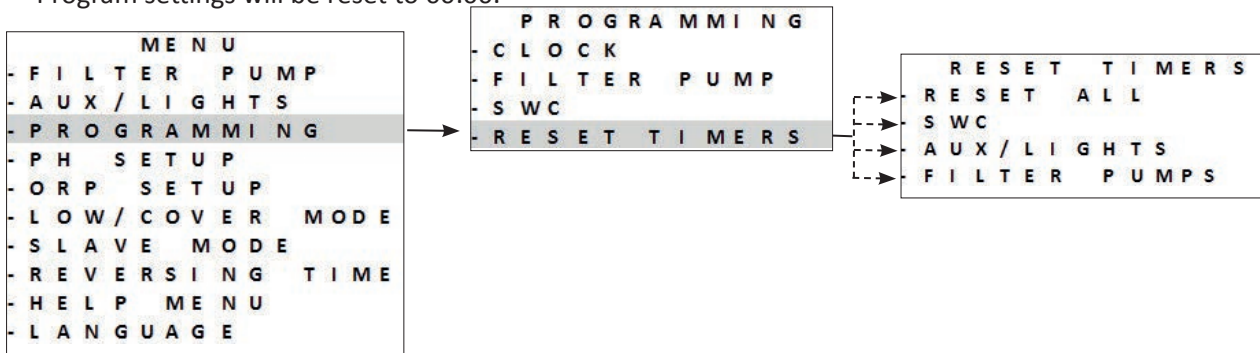

5.2.9 Using with with filtration unit

With this configuration, it is the filtration unit which powers the appliance on or off.



• This connection mode is not recommended as the appliance has its own internal Timers.

- To be controlled by a filtration unit, the appliance's programming must be reset, see «**5.2.8 Clearing programming settings**».
- After the connection to the filtration unit is made, turn the device off then back on again.

5.2.10 Slave mode

«Slave» mode relinquishes control of the chlorination function to an external controller. The external controller must be connected to the  connection point in the low voltage raceway, see «2.5 I Electric connections».

«Boost» and «Low» modes will remain operational from the device. However, device programs will be deactivated. Chlorination output will be maintained at 100%.

- Connect the external controller at the slave connection point in the ow voltage raceway, see «2.5 I Electric connections».
- Press  and browse the menu using the   buttons. Press  to confirm.

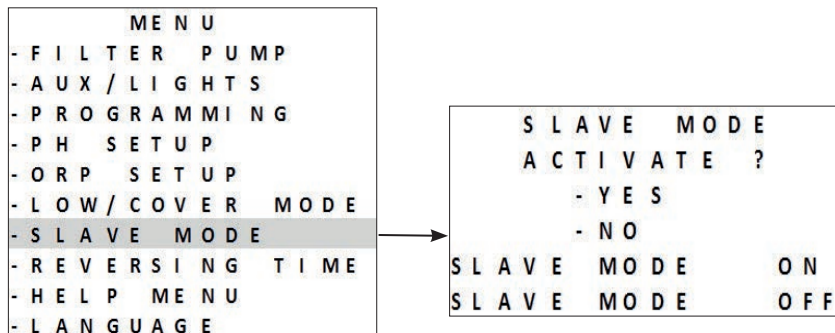

- Press  to exit.

«Slave» mode only controls the chlorination. Filtration pump, AUX, lights and other functions are still valid. Pressing  will take priority over «Slave» mode.

If a Dual Link module is installed, the ORP function is overridden by the «Slave» mode. The pH regulation is still valid.

«LOW» / «COVER» / «BOOST» modes takes priority over «Slave» mode.



The slave mode operates in «closed contact = chlorination ON / open contact = PFF chlorination» no.

5.2.11 Setting the polarity reversal time

The principle of polarity reversal is to eliminate the scaling that builds up on the electrodes by reversing the electrical current for a set length of time. By default, the cycle reverses **every five hours**.

Depending on location, water will be more or less hard (calcium hardness = TH).

To preserve the electrodes from scaling (which reduces the effectiveness of the electrolysis reaction), the polarity reversal time can be changed.

- Before setting the polarity reversal time, analyse the hardness of the pool's water (TH), see «4.2 I Water balance».

Calcium hardness (TH)	Duration of the reversal interval (hours)
< 15°f (150 mg/ L or ppm)	6 - 8
15 - 30°f (150 - 300 mg/ L or ppm)	5
30 - 40°f (300 - 400 mg/ L or ppm)	3 - 4
> 40°f (400 mg/ L or ppm)	2 - 3

- Press **MENU** and browse the menu using the **▲** **▼** buttons. Press **OK** to confirm.
- Choose the polarity reversal duration (setting possible every 2 to 8 hours) using the **▲** **▼** buttons. Press **OK** to confirm.

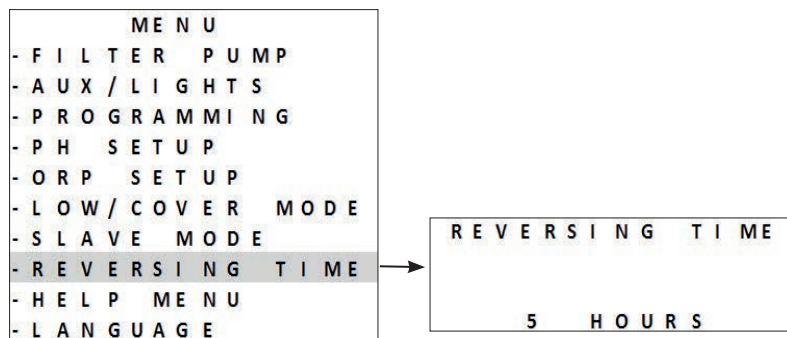

- Press **MENU** to exit.



During reversal, chlorination is stopped for a few minutes. No message is displayed on the screen. Normal operation will resume after the reversal.

5.3 I Calibrating the sensors (if an optional pH Link or Dual Link module is installed)

5.3.1 Calibrating the pH sensor (blue)

The pH sensor may be calibrated in 1 point calibration or 2 points (pH 4 and pH 7); **2 point calibration is recommended for more accurate measurement.**

Current setpoints are displayed on the Home screen whenever the device is ON.

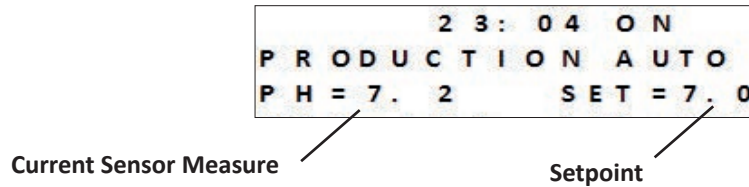

- Turn on the device.
- Turn off the pool pump and close valves as necessary to isolate the cell and sensors.
- Press **MENU** and browse the menu using the **▲** **▼** buttons. Press **OK** to confirm.
- Select 1 or 2 point calibration (2 point calibration is recommended):

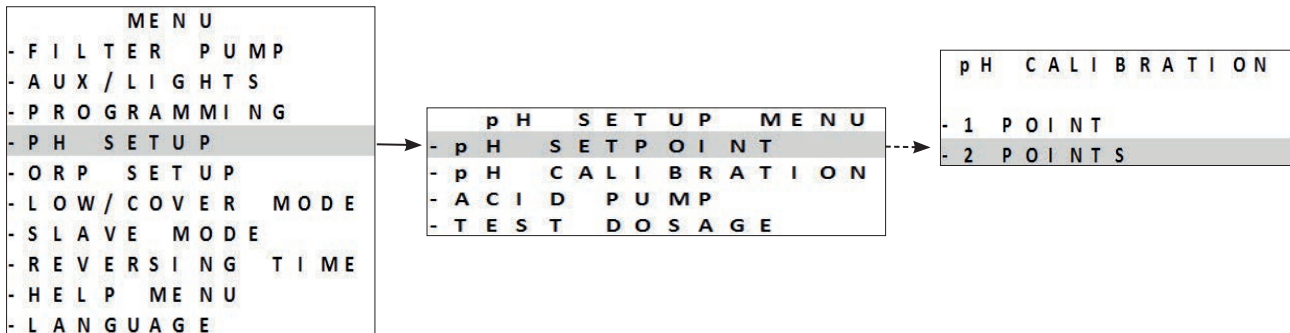

- Unscrew the pH sensor from the POD.
- Rinse the end of the sensor with tap water.
- Shake off excess water. Do not touch the glass bulb at the end of the pH sensor.
- Place the pH sensor in the pH 7 solution and follow the steps on the display:

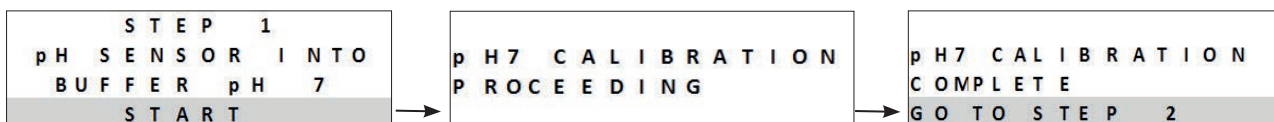

- Rinse the end of the sensor with tap water.
- Shake off excess water. Do not touch the glass bulb at the end of the pH sensor.
- Place the pH sensor in the pH 4 solution and follow the steps on the display:

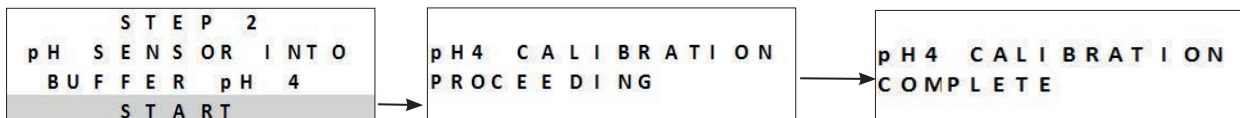

- Once calibration is complete, replace the sensor on the POD.
- If calibration is unsuccessful, see «7.1 I Appliance behaviour».



1 point calibration: possible if the pH 7 and pH 4 solutions provided are not available.

For this:

- Use a sample of water for which you know the pH value.

CHOOSE THE pH OF
CALIBRATION
7.0 >

- Activate the 1 point calibration and fill in this pH value on the screen:

5.3.2 Setting the pH setpoint

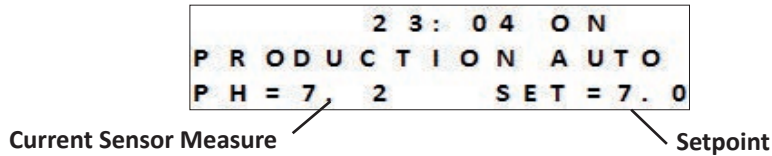

Establishing the pH setpoint determines when acid will be added to the system to decrease the pH of the water. **Default pH setting is 7.2.** To find out the value of the setpoint to be set, refer to Taylor's watergram, see «4.1.3 Weekly analysis».

- Press **MENU** and browse the menu using the **▲** **▼** buttons. Press **OK** to confirm.
- Select the desired setpoint value (from 6.8 to 7.6 is possible):

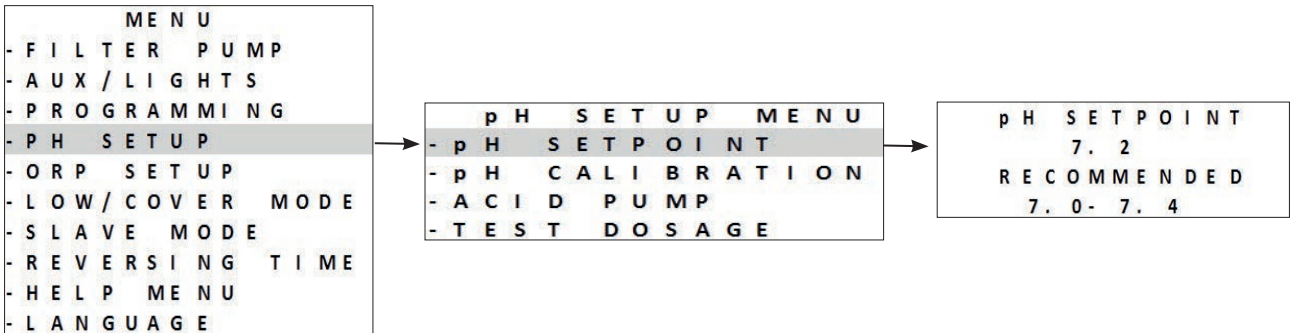

Appliance pH injection programme :

Example of 4 cycles with a set point at 7.4 pH and acid regulation (standard alkalinity):

- **pH ≥ 7.55**: 20% injection (2 min) & 80% pause (8 min)
- **pH ≥ 7.7**: 50% injection (5 min) & 50% pause (5 min)
- **pH ≥ 7.85**: 75% injection (7 min 30 sec) & 25% pause (2 min 30 sec)
- **pH > 7.9**: 100% injection (10 min)

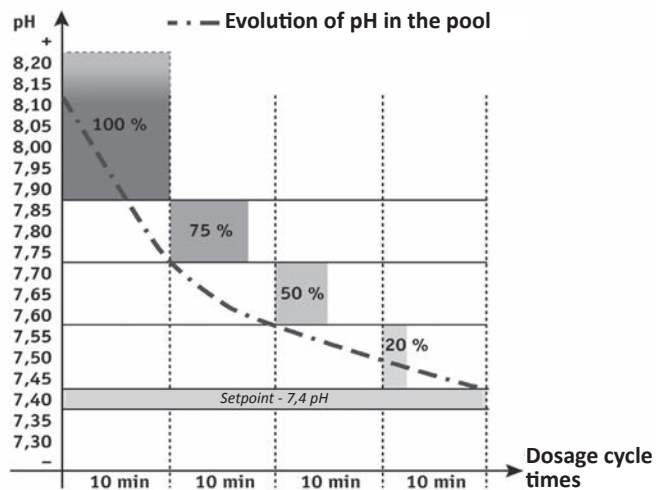

5.3.3 Calibrating the ORP sensor

```

                2 3: 04 ON
P R O D U C T I O N A U T O
P H = 7 . 2      S E T = 7 . 0
O R P = 5 0 0    S E T = 7 5 0
    
```

Current Sensor Measure (ORP = Redox)

Setpoint

The ORP sensor may be calibrated in 1 point (ORP 470 mV);
Current setpoint is displayed on the Home screen whenever the device is ON.

EN

- Turn on power to the device.
- Turn off the pool pump and close valves as necessary to isolate the cell and sensors.
- Press **MENU** and browse the menu using the **▲** **▼** buttons. Press **OK** to confirm.

```

      M E N U
- F I L T E R   P U M P
- A U X / L I G H T S
- P R O G R A M M I N G
- P H   S E T U P
- O R P   S E T U P
- L O W / C O V E R   M O D E
- S L A V E   M O D E
- R E V E R S I N G   T I M E
- H E L P   M E N U
- L A N G U A G E
    
```

(ORP = Redox)

```

O R P   S E T U P   M E N U
- O R P   S E T P O I N T
- O R P   C A L I B
    
```

- Unscrew the ORP sensor from the POD.
- Rinse the end of the sensor with tap water.
- Shake off excess water. Do not touch the the end of the ORP sensor.
- Place the ORP sensor in the ORP 470 mV solution for one minute and follow the steps on the display:

```

O R P   C A L I B R A T I O N
      B U F F E R   4 7 0 m V
      S T A R T
    
```

(ORP = Redox)

```

O R P   C A L I B R A T I O N
P R O C E E D I N G
    
```

```

O R P   C A L I B R A T I O N
C O M P L E T E
    
```

- Once calibration is complete, replace the sensor on the POD.
- Press **MENU** to exit.
- If calibration is unsuccessful, see “7.1 I Appliance behaviour”.

5.3.4 Setting the ORP setpoint

Establishing the ORP setpoint determines when chlorine is produced by the appliance. Free chlorine level should be checked every few days after initial installation. **Default ORP setting is 700 mV.** The setpoint value depends on the pool environment, its use, the rate of stabiliser present in the pool water and so on.

- Press **MENU** and browse the menu using the **▲** **▼** buttons. Press **OK** to confirm.
- Select the desired setpoint value (from 600 mV to 900 mV is possible) using the **▲** **▼** buttons.
- Press **OK** to confirm.



5.3.5 pH pump activation

To avoid any exposure to acid during use, the dosing pump is deactivated for the first 8 hours the appliance operates. During these first 8 hours, the pH value measured and displayed is «---».



- **Hydrochloric acid is a hazardous chemical that may cause burns, lesions, and irritations. Handle with extreme care using protective equipment (gloves, goggles, coveralls). Refer to the substance SDS sheet for more information.**
- **Always pour acid into water.**
- **Once cleaning is complete, dispose of the solution according to standard in effect in the country of use.**

- The pH pump may be activated manually during this 8-hour period, press **MENU** and browse the menu using the **▲** **▼** buttons. Press **OK** to confirm.

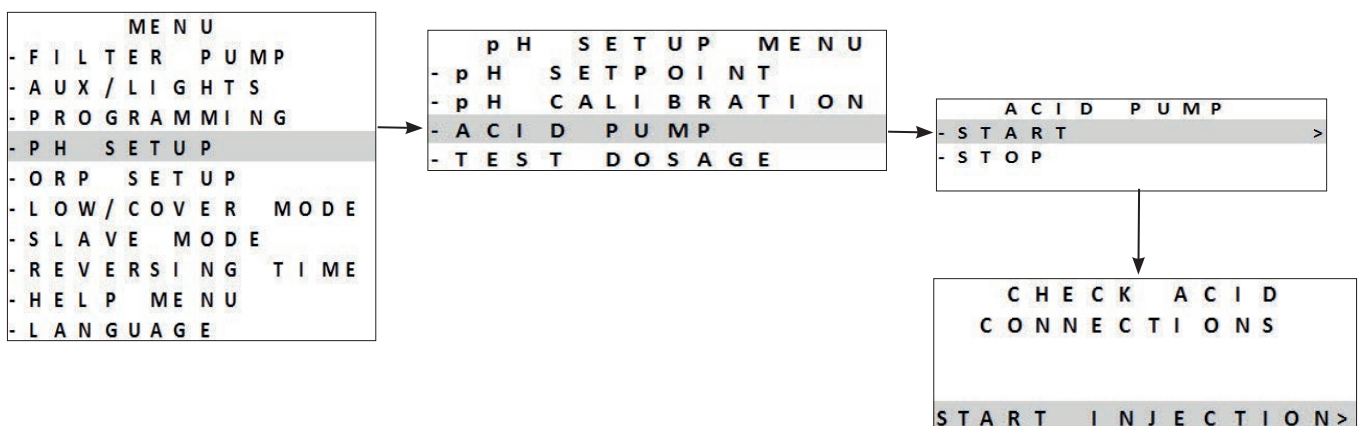

- Press **MENU** to exit.

5.3.6 Pause the pH Dosing Pump

To prevent acid injection when it is not required: It is possible to stop the pH dosing pump for 8 hours.

- Press **MENU** and browse the menu using the **▲** **▼** buttons. Press **OK** to confirm.

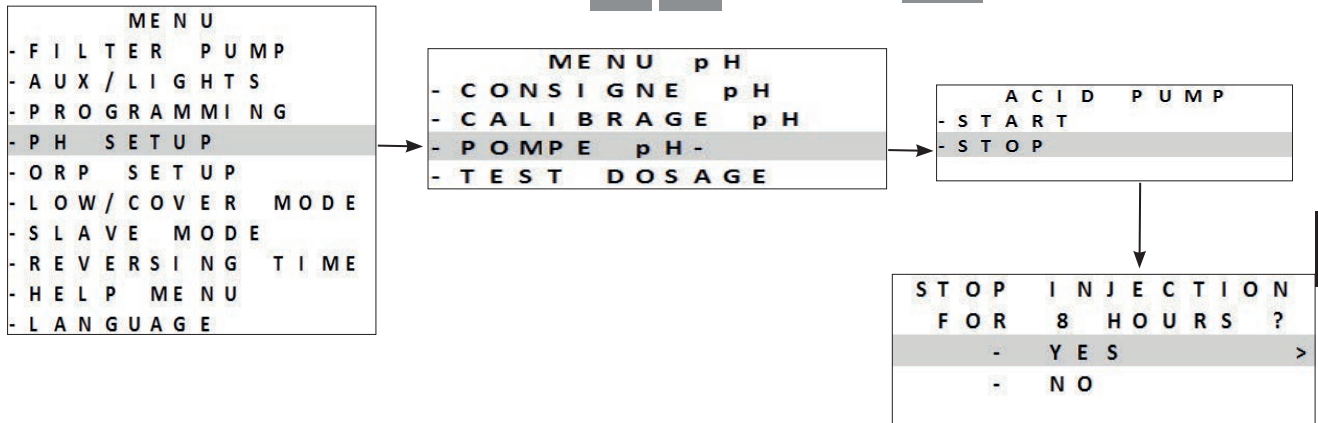

EN

- Press **MENU** to exit.

5.3.7 Test the pH Dosing Pump

The pH dosing pump can be directly activated directly in order to perform a five-minute operating test.

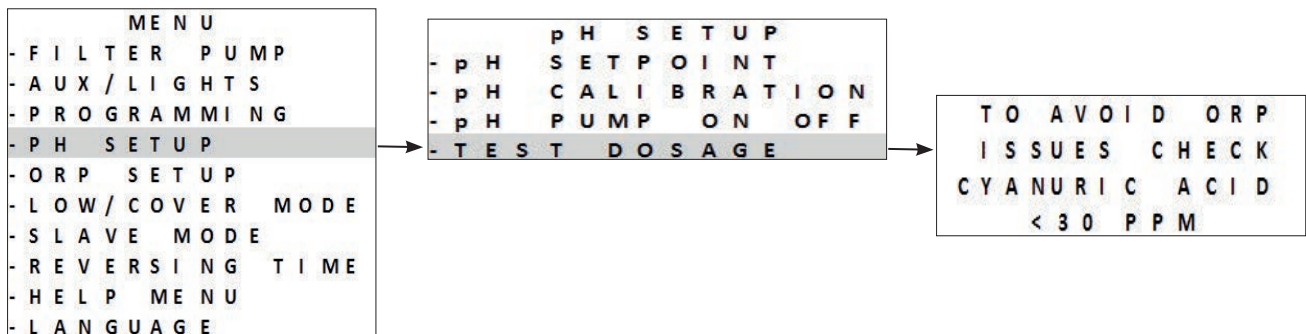

- Press **MENU** and browse the menu using the **▲** **▼** buttons. Press **OK** to confirm.



- The acid pump will perform a five-minute operating test.
- Pump stops automatically upon completion of the five-minute test.
- Press **MENU** to exit.

➤ 5.4 I Regular use

5.4.1 Adjusting chlorine production

From factory, the chlorination is set at 50 %. It can be set between 0 and 100 % in 10 % increments from the “main screen” by pressing   . The set value is valid until the next modification.



The term «standard» chlorination is used when the chlorine production is managed manually (no «Boost» mode or «Low» mode activated and with no ORP regulation connected).

5.4.2 "Boost" mode

In some cases, the pool may require a higher than normal chlorination level such as in cases of high use, poor weather or at the start of the season. «Boost» mode is used to increase the chlorine level quickly.

«Boost» mode lasts for 24 cumulative hours at a production rate of 100 %. If the program is set to perform chlorination 12 hours per day, «Boost» mode will be active for 12 hours on the first day and 12 hours on the second day.

If the filter pump is connected to the device, the filter pump will operate in «Boost» mode also. The chlorination and filtration timers are temporarily ignored for the duration of the «Boost» mode.

Once «Boost» mode completes, the device and filter pump will resume programmed operations.



If the device is equipped with a Dual Link module, the «Boost» mode will not take the ORP value into account. The «Boost» mode takes priority over the ORP regulation

- Press  .

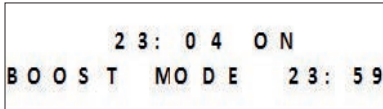

```
23: 04 ON  
B O O S T   M O D E   23: 59
```



- If the device is in «Low»/«Cover» mode you will need to confirm that you want «Boost» mode to override «Cover» or «Low» mode settings.

5.4.3 "Low" mode

«Low» mode is designed to reduce chlorine production in situations where the pool is covered or when pool use is limited. Chlorine production needs will be lower when pool use is low and/or when pool water is not exposed to UV rays etc.

«Low» mode output can be set in the main menu settings for «Low»/«Cover» mode.

«Low»/«Cover» mode can be set from 0%- 30% in 10% increments. Programs are still active while the device is in «Low»/«Cover» mode.

- To manually enter «Low» mode press  .
- To exit «Low» mode press  again.

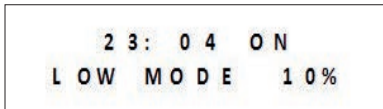

```
23: 04 ON  
L O W   M O D E   10%
```

5.4.4 "Cover" mode

If the pool is equipped with a compatible electric roller cover (contact closed = shutter closed), this can be connected to the device in order to automatically reduce chlorination upon closing the cover, this is known as «Cover» mode. Chlorination will resume at the level determined by the programming upon opening the compatible electric cover.

«Cover» mode output can be set in the main menu settings for «Low»/«Cover» mode.

«Low»/«Cover» mode can be set from 0%- 30% in 10% increments. Programs are still active while the device is in «Low»/«Cover» mode.

Check that the cover is compatible and connected to the chlorinator :  connection point in the low voltage raceway, see «2.5 I Electric connections».

«Cover» mode will automatically be activated when the cover is closed. The «Cover» mode message and the output percentage are displayed on the screen.

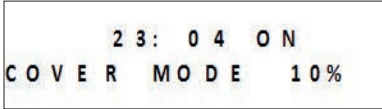

```

2 3: 0 4 O N
COVER MODE 10%

```

«Cover» mode will stop as soon as the cover is completely open.

If the device is equipped with a Dual Link module we do not recommend connecting the «Cover» mode. More specifically, chlorination is managed via the Dual Link module. In cases where the «Cover» mode is connected in the presence of a Dual Link module: chlorination will take place upon closing the roller cover, even if the ORP measurement is greater than the setpoint value.

5.4.5 "Cold water" failsafe mode

In addition to displaying the water temperature, the temperature sensor is used to protect the cell, which is sensitive to cold water (reduction in conductivity between the plates and so increase in voltage).

The temperature displayed on the top left of the home screen will begin to flash at 15°C.



```

1 5° 2 3: 0 4 O N

```

When water temperature is under or equal to 15°C, chlorine production automatically switches to the level defined in «Low»/«Cover»mode (between 0 and 30%).



When water temperature is under or equal to 10°C, chlorine production is stopped. The absence of chlorination at this temperature is not issue, as bacterial development is slowed in cold water.



In addition to the flashing temperature, a "LOW TEMPERATURE" message is alternately displayed.

When the temperature goes over 10°C again, the output percentage will be set to «Low»/»Cover».

When the temperature goes over 15°C again, chlorination resumes its level of operation configured using programs.

5.4.6 Locking the interface

The device can be locked, thus deactivating the buttons on the user interface panel. Simultaneously press and hold the  and  buttons for 3 seconds. This function can be accessed from any screen/menu.

Locking the device automatically returns the user to the home screen. To unlock the device, press and hold the  and  buttons for another 3 seconds.



6 Maintenance

6.1 I Cleaning the sensor(s)

Sensor(s) must be cleaned every 2 months.

- Turn off the filter pump.
- Close all valves.
- Remove the sensor and the sensor holder from the POD.
- Rinse the sensor with tap water for 1 minute.
- Shake off excess water.



To avoid damaging the active part, do not rub or dry with a cloth.

- Brush the junctions and the metal part (Gold) for the ORP sensor using a toothbrush for 1 minute.



- Prepare a diluted hydrochloric acid solution by pouring 1 mL (10 drops) of commercially-available hydrochloric acid (HCl 37%) into 50 mL of tap water (1/2 glass of water).



- **Hydrochloric acid is a hazardous chemical that may cause burns, lesions, and irritations. Handle with extreme care using protective equipment (gloves, goggles, coveralls). Refer to the substance SDS sheet for more information.**
- **Always pour acid into water instead of pouring water into acid.**
- **Once cleaning is complete, dispose of the solution according to standard in effect in the country of use.**

- Wash the sensor in the diluted hydrochloric acid solution for 2 minutes.
- Rinse sensor in clean tap water for 1 minute.
- Shake off excess water.
- **Then calibrate the sensor, see «5.3 I Calibrating the sensors (if an optional pH Link or Dual Link module is installed)».**
- Put the sensor holder and the sensor in place on the POD Kit.

6.2 I Checking and cleaning the electrodes



The appliance is equipped with a smart polarity reversal system designed to prevent the electrode plates from scaling. The duration of the polarity reversal can be changed, see «5.2.7 Selecting an outside device». However cleaning may be required in regions where the water is very hard. This will also limit the formation of a soft paste due to the phosphate rate.

- Turn off the chlorinator and the filtering, close the isolation valves, remove the protection cover and disconnect the cell power cable.
- Unscrew the tightening ring and remove the cell, **see illustration 1**. The ring is crenelated thus allowing a lever to be used in the event of it jamming. Immerse the part which contains the electrode plates in a suitable container with the cleaning solution.
- Leave the cleaning solution to dissolve the scaling for about 15 minutes. Dispose of the cleaning solution at an approved waste recycling site, never pour into the rainwater drainage system or into the sewers.
- Rinse the electrode using clean water and put it back on the cell fixture collar (there is an alignment foolproof).
- Refit the tightening ring, reconnect the cell cable and refit the protective cover.
- Open the isolation valves, then restart the filtering and chlorinator.

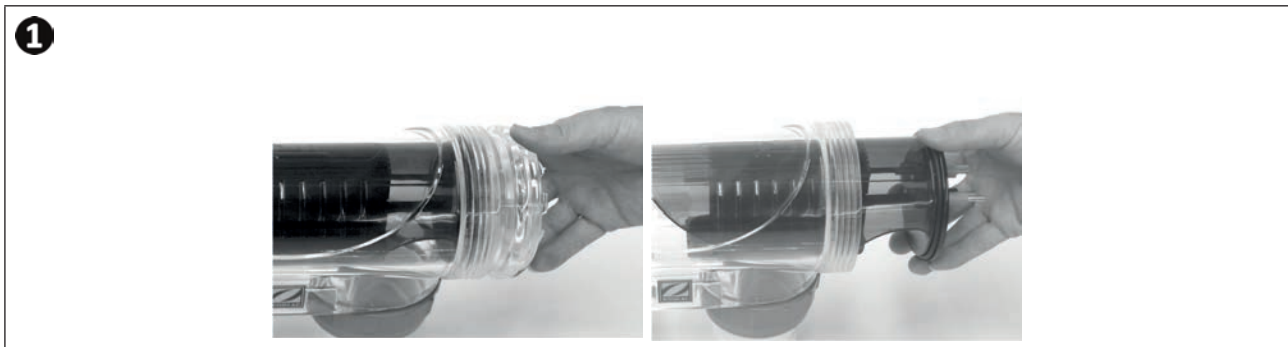

If you do not use an off the shelf cleaning solution, you can make your own by carefully mixing one part of hydrochloric acid in nine volumes of water (Caution: always pour the acid into the water and not the opposite and wear suitable protective equipment!).

6.3 I Washing the pool filter (backwash)

Backwash mode is used to quickly start/stop the filter pump (single- or variable-speed pump) in order to backwash the filter.

- Press **MENU** and browse the menu using the **▲** **▼** buttons. Press **OK** to confirm.
- Select **ON** to activate filtration or **OFF** to stop filtration.

```

    MENU
  - FILTER PUMP
  - AUX / LIGHTS
  - PROGRAMMING
  - PH SETUP
  - ORP SETUP
  - LOW / COVER MODE
  - SLAVE MODE
  - REVERSING TIME
  - HELP MENU
  - LANGUAGE
  
```

```

    FILTER PUMP
  - QUICK CLEAN
  - SINGLE SPEED
  - ZODIAC VS
  
```

```

    QUICK CLEAN
  FILTRATION PUMP
  - ON
  - OFF
  
```

For safety reasons, the chlorination is stopped during the backwash mode. To avoid emptying the pool, the backwash mode automatically stops after 5 minutes. The variable speed pump RPM is by default set at 3450 rpm (max speed). This can be changed in the priming menu.

➤ 6.4 I Winterizing



The device is equipped with a protection system that limits chlorine production under adverse operating conditions like cold water (in winter) or when there is too little minerals.

- **Active wintering** = filtering operational in winter: below 10 °C it is preferable to switch off the chlorinator. Above this temperature you can leave it running.
- **Passive wintering** = lower water level and drained piping: switch off the appliance and leave the electrode dry in its cell with its isolation valves, if any, open.
- **Sensor wintering** = Keep the sensor's plastic tube (which contains a storage solution) to re-use it during wintering. The sensors must always be stored damp (never dried out). They must be stored in the tube filled with a 3 mol/L KCl storage solution or at least in tap water.

➤ 6.5 I Returning the pool to service

Required actions:

- Adjust the water level (too much or not enough).
- Check the water: TAC/TH/pH/Salinity/Chlorine/Stabiliser/Copper/Metals and adjust the parameters to obtain a balanced and healthy pool, see «4.2.1 Water balance».
- Check the condition of the equipment (pump, filter, electrolyser, electrolysis cell).
- Check the sensors then clean and recalibrate.
- As soon as the mineral rate reaches the required level and is fully dissolved in the water, restart the appliance.



7 Troubleshooting





- Before you contact your retailer, please carry out these few simple checks using the following tables if a problem occurs.
- If the problem continues, contact your retailer.
-  : Actions to be performed by a qualified technician only

7.1 I Appliance behaviour





The information messages may be hidden by pressing for  4 seconds.
Certain messages require human intervention and cannot be hidden.

EN

7.1.1 Appliance WITHOUT with pH Link or Dual Link module

Message	Possible Cause	Solution
«NO FLOW» «CHECK PUMP» ("INFO" indicator lit during the production timers)	<ul style="list-style-type: none"> • Filter pump failure. • Filter and/or the skimmer(s) are dirty. • By-pass valve(s) closed. • Flow switch disconnected or defective. 	<ul style="list-style-type: none"> • Check the pump, the filter, the skimmer(s), and the by-pass valve(s). Clean them if necessary. • Check the wire connections (flow switch). • Check that the flow switch is working correctly (replace it if necessary: contact the retailer) .
«CHECK OUTPUT» ("INFO" indicator flashing)	<ul style="list-style-type: none"> • Cell power cord disconnected or not properly connected to the cell or inside the device. • Wear, calcification or breakage of the cell plates. • Internal electronic problem in the control box following an external electric incident. 	<ul style="list-style-type: none"> • Switch off the device () button) and switch off the power supply to the control box, then check that all the wires are properly connected (mains power supply, cell, etc.). • Replace the cell. • Check the supply board: contact the reseller) .
«LOW CONDUCTIVITY» ("SALTS" indicator lit)	<ul style="list-style-type: none"> • For models with a temp sensor, this error may be caused by low water conductivity (lack of minerals). If there is no temperature sensor: this error may be due to a low water temperature or a low mineral rate. • Lack of minerals due to water loss or dilution (filter backwash, water renewal, rain, leaks, etc.). • Can vary depending on the temperature and age of the cell. The voltage across the cell terminals varies in time. • Wear, calcification or breakage of the cell. 	<ul style="list-style-type: none"> • Check water temperature. • Check the condition of the cell plates. • Measure the minerals concentration in the pool water using a salinity tester or a test strip, then add minerals to the pool to keep the level at 4 g/L. If you do not know the minerals level or how to test it, contact your retailer.
«OVERHEAT» ("INFO" indicator lit)	<ul style="list-style-type: none"> • The temperature inside the control box is too high, chlorination is slowed (>85°C) then stopped (> 90°C) if the temperature does not fall back down in order to protect the electric circuits. 	<ul style="list-style-type: none"> • If the box is installed outdoors, protect it from direct sunlight. • Chlorination will automatically resume once the temperature has fallen back down. • Issue at the device.
«LOW WATER TEMP» ("INFO" indicator light is lit, the temperature on the display flashes)	<ul style="list-style-type: none"> • The water temperature measured by the device temperature sensor is less or equal to 10°C; production stops in order to protect the cell. 	<ul style="list-style-type: none"> • Chlorination will automatically resume at the Low Mode chlorination rate between 10 and 15°C. • Chlorination will automatically resume at the normal chlorination rate above 15°C.
(NONE MESSAGE) Chlorine production not visible at the cell plates	<ul style="list-style-type: none"> • Chlorination is in a reversing period. • Chlorination is set at less than 100% and is paused. 	<ul style="list-style-type: none"> • Wait and observe, chlorination should resume in the next 10 minutes.

7.1.2 Appliance WITH with pH Link or Dual Link module

Message	Possible Cause	Solution
«LOW pH» ("INFO" indicator lit)	<ul style="list-style-type: none"> The pH level is less than 5. The pH sensor is disconnected, dirty, uncalibrated or not working. Alkalinity is low, the pH minus 	<ul style="list-style-type: none"> Check the pH sensor wiring on the control box and on the sensor holder. Check the operation of the sensor using a sensor tester (contact the retailer) . Clean and calibrate the sensor. Check and adjust alkalinity. Replace the sensor.
«pH DOSING STOP» ("INFO" indicator flashing)	<ul style="list-style-type: none"> The pH setpoint has not been reached after 5 cumulative hours of injection. The pH sensor is disconnected, dirty, uncalibrated or not working. The pH minus container is empty. The peristaltic pump is not primed. High alkalinity, acid injection does not help to lower the pH. 	<ul style="list-style-type: none"> Check the pH level in the pool using photometer or a test strip. Check the pH sensor wiring on the control box and on the sensor holder. Check the operation of the sensor using a sensor tester (contact the retailer) . Clean and calibrate the sensor. Replace the pH container. Test the peristaltic pump (contact the retailer) . Lower the alkalinity (contact the retailer) . Replace the pH sensor.
«ORP PROD. STOP» ("INFO" indicator flashing)	<ul style="list-style-type: none"> The ORP setpoint has not been reached after 36 cumulative hours of chlorination. The ORP sensor is disconnected, dirty, uncalibrated or not working. When cyanuric acid concentration is too high the efficacy of chlorine is highly reduced. When cyanuric acid concentration is too high it lowers the ORP reading from the sensor. pH is too high. When the total chlorine concentration is too high, chloramines will lower the ORP reading of the sensor. The device is not correctly sized for the pool. When the cell is worn, calcified or out of order the electrolysis reaction is not efficient. 	<ul style="list-style-type: none"> Check the chlorine level in the pool using photometer or a test strip. Check the ORP sensor wiring on the control box and on the sensor holder. Check the operation of the sensor using a sensor tester (contact the retailer) . Clean and calibrate the sensor. Drain the pool using the main drain in order to lower the cyanuric acid concentration. Proceed to a shock chlorination (using calcium hypochlorite) to reduce the chloramines concentration. Check the cell conditions. Replace the ORP sensor.



Tip: if you require assistance, inform your retailer about the appliance's condition to save time

7.2 I Effects of the stabiliser on the chlorine and the ORP

A pool has a stabiliser content of 30 ppm and a pH of 7.4.

1 ppm free chlorine = 700 mV

Therefore, the user can set their chlorination requirement to 700 mV to maintain a level of 1 ppm in the pool. If the level of stabiliser increases to 90 ppm, the ORP reading will be false.

1 ppm free chlorine = 500 mV

If the user keeps his setpoint at 700 mV, he will end up chlorinating up to 5 ppm !

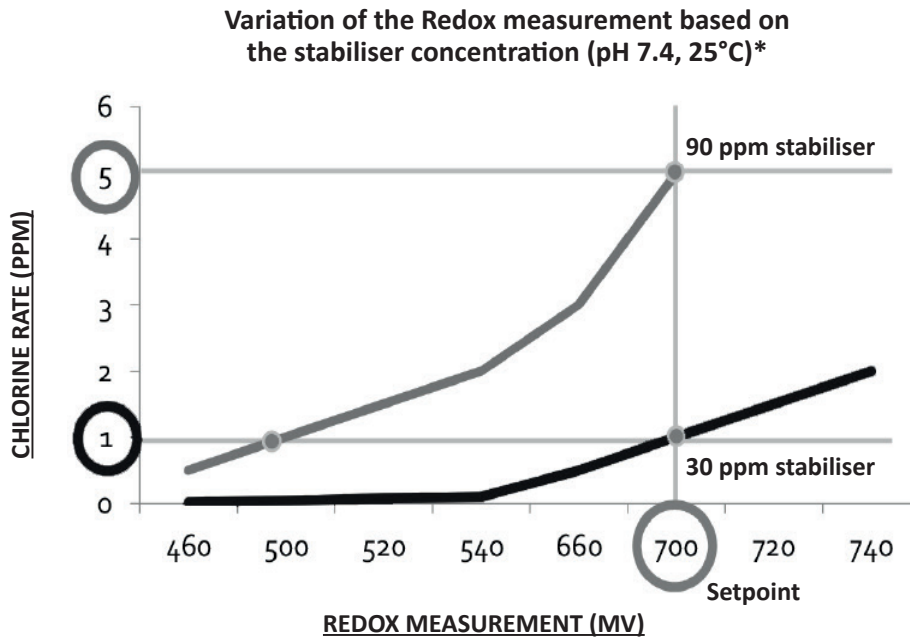

* Theoretical values to explain the principle. Actual values may vary slightly depending on various pools waters

7.3 I "Help" menu

The chlorinator will automatically notify you of any problems by displaying information messages. To help with the understanding of these messages, the device has a troubleshooting assistance menu which gives the meanings and the action to take to solve the problem.

- Press **MENU** and browse the menu using the **↑** **↓** buttons. Press **OK** to confirm.
- Select the error message using the **↑** **↓** buttons. Press **OK** to confirm.

M E N U	
-	F I L T E R P U M P
-	A U X / L I G H T S
-	P R O G R A M M I N G
-	P H S E T U P
-	O R P S E T U P
-	L O W / C O V E R M O D E
-	S L A V E M O D E
-	R E V E R S I N G T I M E
-	H E L P M E N U
-	L A N G U A G E

- The display will automatically scroll through a certain number of suggested solutions to explain what to do. Once automatic scrolling is complete, the chlorinator automatically returns to the "Troubleshooting" menu.
- Press **MENU** to exit.

Votre revendeur
Your retailer

Modèle appareil
Appliance model

Numéro de série
Serial number

Pour plus d'informations, enregistrement produit et support client :
For more information, product registration and customer support:

www.zodiac.com

